



IMSA Traffic Signal Field Technician II



Advancing the Future of Public Safety

Central Section IMSA shall not be liable for damages of any kind resulting from errors or omissions in the training materials nor shall we be liable for any damages resulting from the use of the training materials or other information conveyed at Central Section IMSA course(s).

The Central Section IMSA may from time-to-time provide various courses, programs, and associated material for sale on this Website. We grant you a limited, personal, non-exclusive, non-transferable license to use our courses, programs, and associated material (collectively the “Courses”) for your own personal or internal business use. Except as otherwise provided, you acknowledge and agree that you have no right to modify, edit, copy, reproduce, create derivative works of, reverse engineer, alter, enhance or in any way exploit any of the Courses in any manner.



Advancing the Future of Public Safety

Disclaimer

By ordering or participating in Courses, you agree that the Courses you purchase or download may only be used by you for your own personal or business reference and may not be sold or redistributed without the express written consent from us. By ordering or participating in Courses, you further agree that you shall not create any derivative work based upon the Courses and you shall not offer any competing products or services based upon any information contained in the Courses.

Intent of Refresher Session

- This review is not intended to cover every aspect of the exam and is not limited to the content, or questions found on the exam.
- To briefly review the required technical knowledge and understanding of a typical Traffic Signal Technician gained through job experience and previous training.
- Review the latest concepts of industry standards in an overview format designed to promote group discussion and sharing of ideas.
- Questions should be asked as the presentation is underway and the topic is under discussion – others will benefit from any questions asked!

Table of Contents

IMSA Traffic Signal Field Technician II

Session 1: Safety Review –

PPE, Governing Agencies, Traffic Control, Utilities & Overhead Safety

Session 2: Electrical Theory - Circuit Calculations, Voltage Drop & Services

Session 3: Cabinets, Components & Configuration

Session 4: Controllers - Intervals, Timing, Cycle Length & Coordination

Session 5: Detection Systems

Session 6: Pedestrian Right-of-Way Guidelines (MUTCD & ADA)

Session 7: Construction

Session 8: Solar Powered Systems & School Flasher Maintenance

Session 9: Troubleshooting Tools / Equipment

Session 10: Traffic Signal Emergency Response

Session 11: Preventative Maintenance (PM)

Glossary

IMSA Traffic Signal Field Technician II

Session 1: Safety Review - PPE, Governing Agencies,
Traffic Control, Utilities and Overhead Safety



Advancing the Future of Public Safety

What do you Remember about PPE?

PPE

- Safety Vests
- Hard Hats
- Safety Toed Work Boots
- Safety glasses
- Electrical gloves
- Harnesses & Lanyards
- Respiratory Protection



Key Points

- ANSI, Class II, Class III
- ANSI, Class G, E, & C
- ASTM F2412 and F2413 standards
- Z87.1 & Z87.1+
- Class 00, 0, 1, 2, 3, & 4
- 5,000 lb. anchor point
- Respirator vs. dust mask

What do you Remember about Governing Agencies and Standards?

Agency Acronym

- FHWA
- MUTCD
- NEC
- NESC
- OSHA
- NEMA
- Caltrans
- ATC/C
- ITE
- **IMSA**

Governing Agency Name

- Federal Highway Administration
- Manual on Uniform Traffic Control Devices
- National Electrical Code
- National Electrical Safety Code
- Occupational Safety & Health Admin.
- National Electrical Manufacturers Assoc.
- California Dept. of Transportation
- Advanced Transportation Controller/Cabinet
- Institute of Transportation Engineers
- **International Municipal Signal Assoc.**

What do you Remember about Traffic Control?

- Traffic Cones
- Traffic Drums (Barrels)
- Barricades
- Flaggers
- High-Visibility Clothing
- Traffic Control Signs
- Arrow Boards or Variable Message Signs
- Temporary Traffic Signals
- Lighting Devices
- Tapering Devices
- Temporary Pavement Markings



What do you Remember about Overhead Safety?

“*Look up and live*” is a saying for a reason:

- Overhead power lines can be deadly; therefore, care must be taken when working near these lines.
- OSHA mandates that you **MUST maintain a MINIMUM of 10 foot of clearance** from overhead power lines (table “A”)

<https://www.osha.gov/laws-regs/regulations/standardnumber/1926/1926.1408>

Understand how power poles are constructed:

- The highest voltage lines will be at top of the pole
- Potential voltages on lines reduce as you come down the pole
- Communications lines will be the lowest lines on the pole, if present
- Look for “*risers*” on poles as overhead utilities may transition to become underground utilities

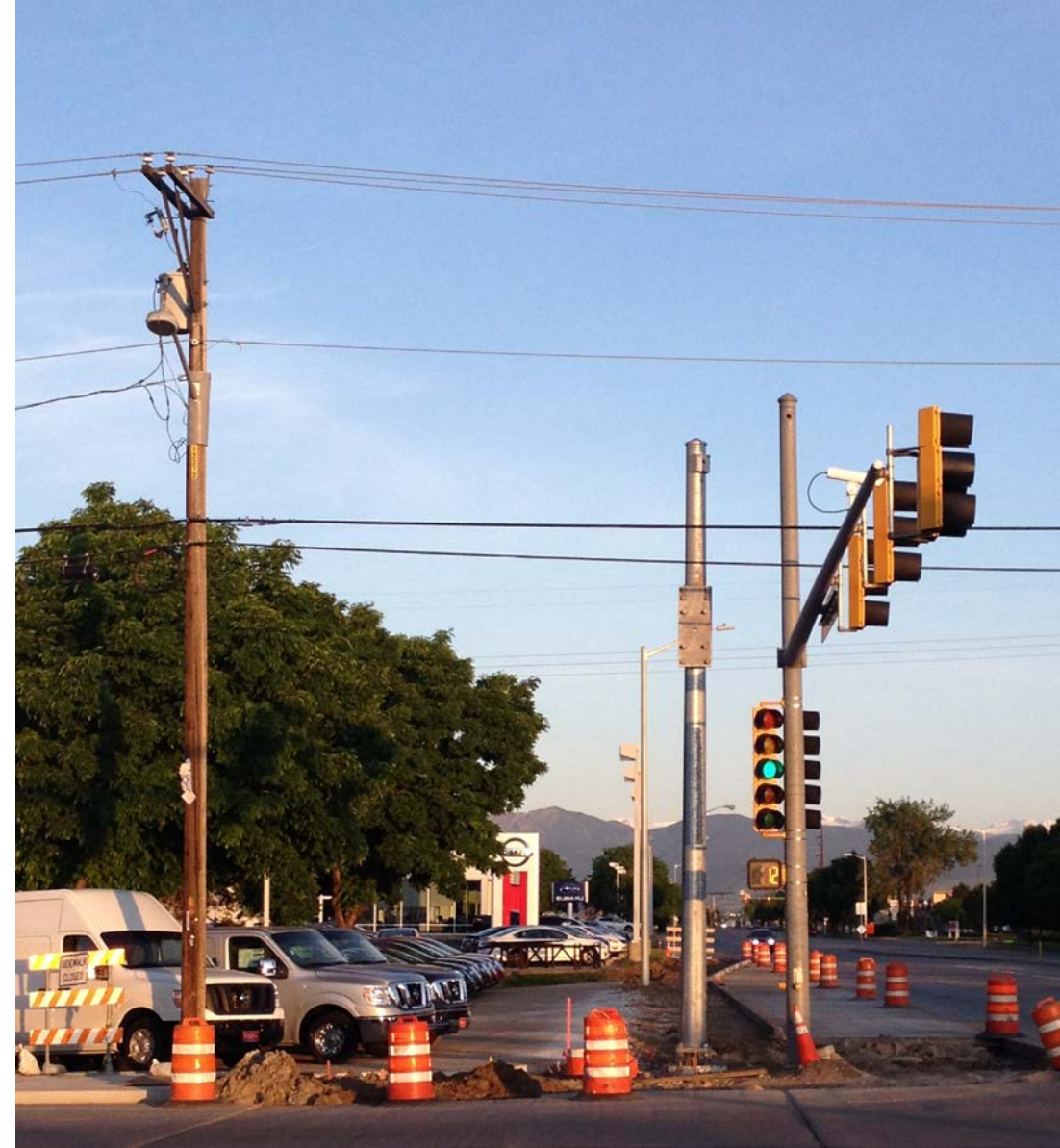

What do you Remember about Utility Locates?

“*Call before you dig*” is another saying for a reason.

- Underground utilities present even more hazards.
- The locate identification colors are as follows:

Locate Color	Utility
Red	Electric Power Lines
Yellow	Natural Gas, Steam, Petroleum, & Oil Lines
Blue	Potable Water Lines
Green	Sanitary Sewer & Storm Drain Lines
Orange	Communications Lines - Phone, Cable TV, Fiber Optic
Pink	Temporary Surveying Markings
Purple	Chilled Water, Reclaimed Water, Irrigation & Slurry Lines
White	Proposed Excavation
Not Specified	Military & Private Underground Facilities



**SAFETY IS IN YOUR HANDS.
EVERY DIG. EVERY TIME.**

The 811 Logo is a registered trademark of the Common Ground Alliance.



IMSA Traffic Signal Field Technician II

Session 2: Electrical Theory - Circuit Calculations,
Voltage Drop and Services



Advancing the Future of Public Safety

Basic Electrical Theory – Units of measure

Current (I) – The amount of electrical flow in a circuit as measured in *Amps*.

Voltage (E) – The amount of electrical pressure in a circuit as measured in *Volts*.

Resistance (R) – The opposition to current flow as measured in *Ohms*.

Power (P) – The amount of electrical energy in a circuit as measured in *Watts*.

Basic Electrical Theory – DC vs. AC current

Current – AC and DC currents are very different.

- **DC current** from the source (such as a battery) is constant and only flows in one direction; hence “Direct Current”
 - Current flows from the positive pole (**red**) to the negative pole (black)
- **AC current** from the source constantly varies and flows back and forth in two directions; hence “Alternating Current”
- The byproduct of current flowing in a circuit is *heat*.



Basic Electrical Theory – DC vs. AC Voltage

Voltage is the electrical pressure behind moving current in a circuit.

Because DC and AC currents are so different, so too are the voltages with respect to polarities.

- Voltage measured in a **DC circuit** is dependent on positive (**Red**) and negative (**Black**) polarities.
 - Therefore, it is important to match the meter leads to the positive and negative terminals of a DC power source to get a positive reading.
- Voltage measured in an **AC circuit** is not as dependent on polarities since the current constantly changes direction.
 - However, to maintain the idea of positive and negative in a circuit, the **red** lead is used on the positive side of the circuit (**black**), and the black lead is used on the negative side of the circuit (**white**).

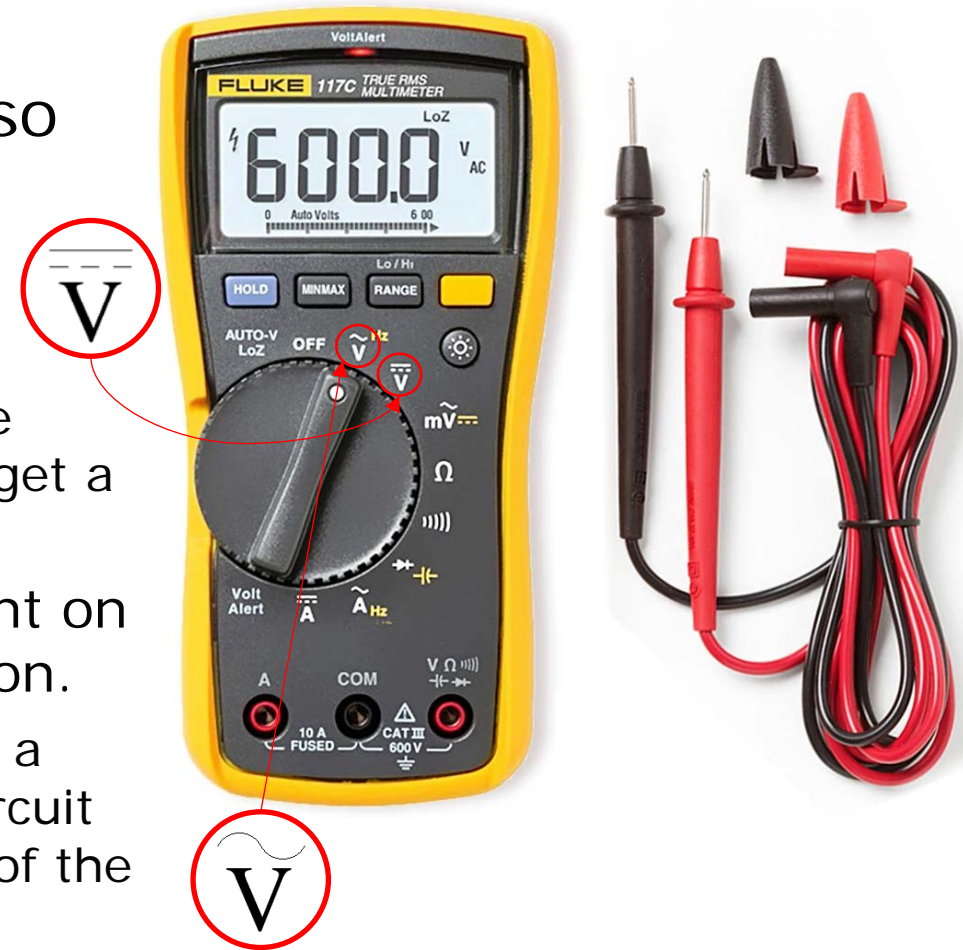

Basic Electrical Theory – Ohms Law & Power Formulas

Ohm's Law

$$E = I \times R$$

$$I = E / R$$

$$R = E / I$$

Power Formulas

$$P = I \times E$$

$$I = P / E$$

$$E = P / I$$

There are multiple voltages typically used in traffic signal circuits; **120 VAC, 24 VDC, 12VDC, 12VAC, 48 VDC, & 3-5 VDC**. These voltages normally remain the same.

If resistance goes up, current & voltage goes down.

If resistance goes down, current & voltage goes up.

The amount of **power consumed** by a circuit is a function of **Voltage** times **Current**.

All electrical equipment and circuits are based on how much power will be consumed.

Basic Electrical Theory – Ohms Law & Power Formulas

A good method for keeping the Ohm's Law and power formulas straight is to use the diagrams below:

- Cover up the value you're looking for
- What's left over is the formula you use to find your answer

Ohm's Law

$$E = I \times R$$

$$I = E / R$$

$$R = E / I$$

Power Formulas

$$P = I \times E$$

$$I = P / E$$

$$E = P / I$$

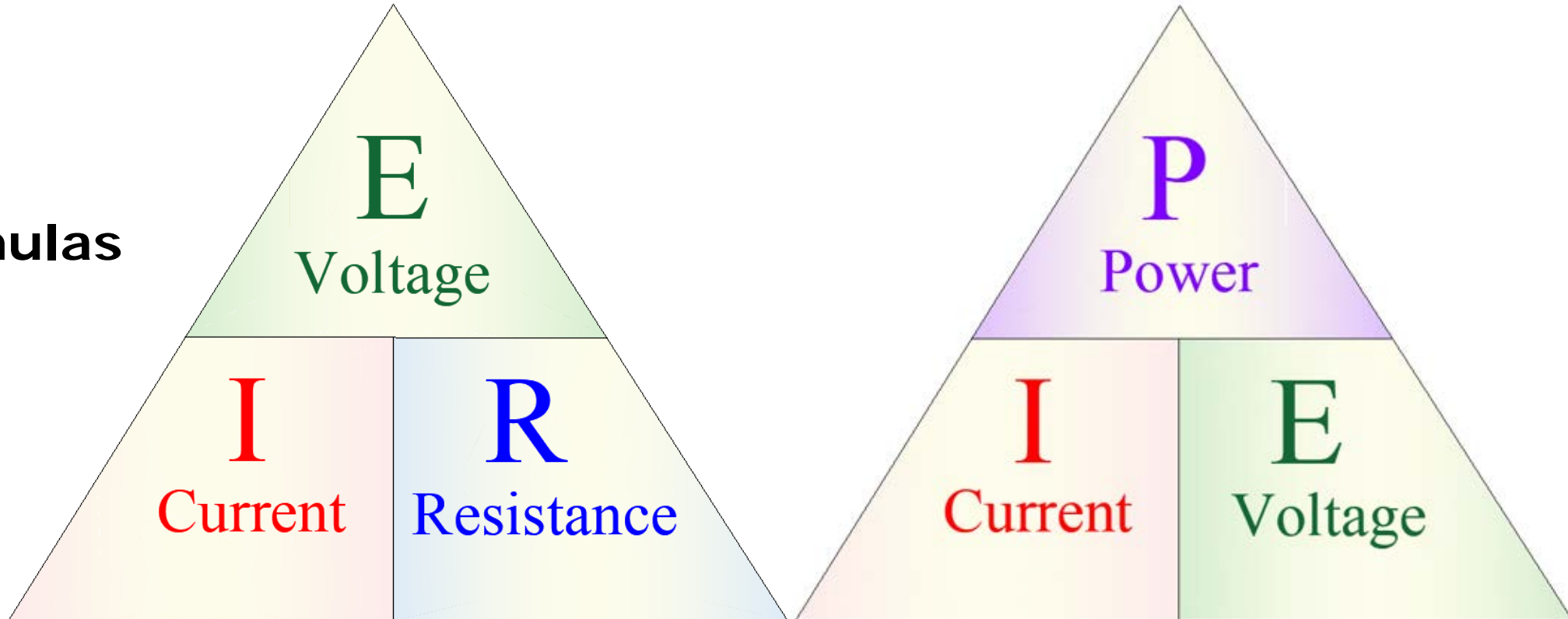

Basic Electrical Theory

Series Circuits

In a series circuit the current remains constant at all points within the circuit.

Current only has one path to flow in the circuit.

An example of a series circuit is a string of lights. If one bulb burns out the entire string of bulbs will be out.

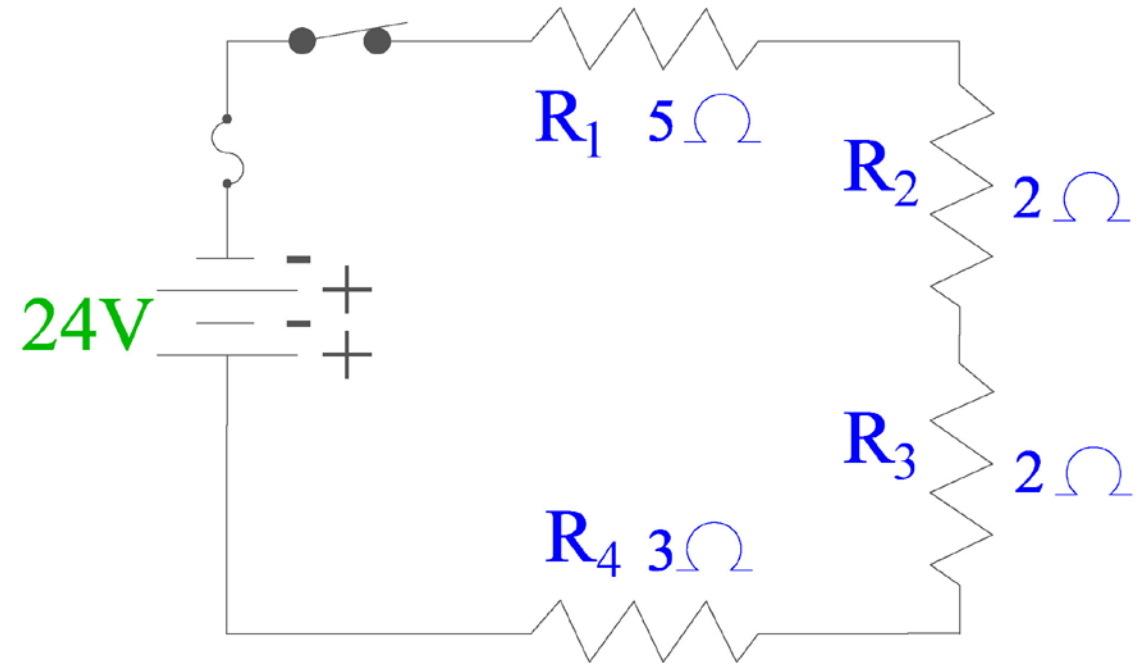

Series Connection

Basic Electrical Theory

Parallel Circuits

In a Parallel circuit voltage remains constant at all points within the circuit.

An example of a parallel circuit is a string of lights. If one bulb burns out the entire string of bulbs will continue to operate minus the bad bulb.

Traffic signal indications are wired in parallel.

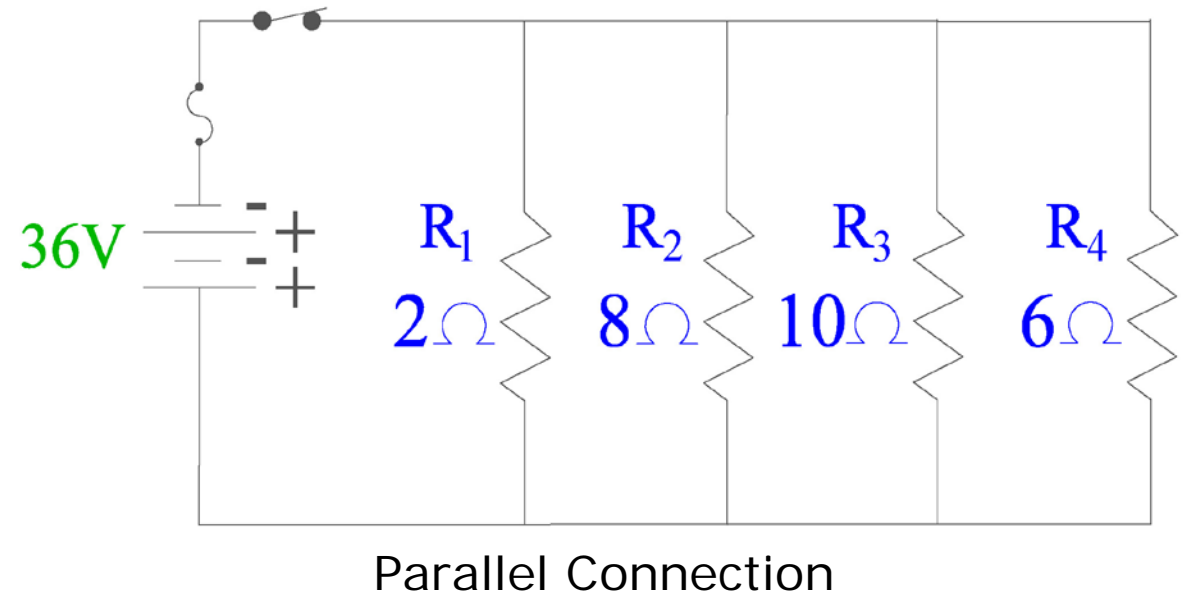

Basic Electrical Theory

Series/Parallel or Combination Circuits

A combination circuit has both series loads and parallel loads.

Traffic signal loop detection may be wired in series, parallel, or in combination.

Circuits on printed circuit boards may also be connected in combination.

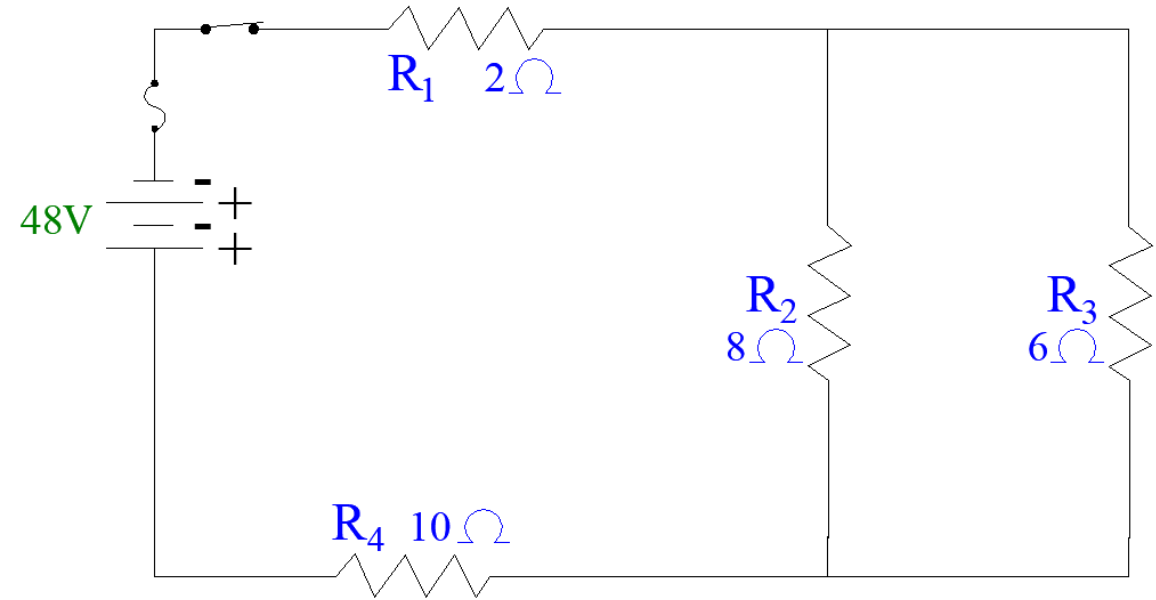

Series/Parallel Connection

Basic Electrical Theory

Voltage Drop

Voltage Drop is defined as *"the decrease of electrical potential along the path of a current flowing in a circuit."*

- In other words, the amount of available voltage decreases over distance in a circuit. For Example:
- The distance from the power source to the traffic signal control cabinet

The table below is a guideline for conductor size, type, distance, and the circuit size.

Voltage Drop table for 120 VAC, Single Phase. Conductor size is based on a 3% voltage drop. This table serves as a guideline only.					
Circuit & type of conductor	Length of the Conductor Run				
	25'	50'	100'	150'	200'
15 Amp - Cu	14 awg	12 awg	10 awg	8 awg	6 awg
20 Amp - Cu	12 awg	12 awg	8 awg	6 awg	4 awg
30 Amp - Cu	10 awg	10 awg	6 awg	4 awg	4 awg
100 Amp - Cu	1 awg	1 awg	1 awg	2/0	4/0
200 Amp - Cu	3/0	3/0	3/0	300MCM	500 MCM
100 Amp - Al	1/0	1/0	2/0	4/0	300 MCM
200 Amp - Al	250 MCM	250 MCM	300 MCM	600 MCM	900 MCM

Basic Electrical Theory – Electrical Service Disconnect

Many agencies require metered service disconnects for their traffic signals.

- Power feeds from the transformer to the meter housing
- Power then feeds to the main breakers in the service disconnect box
 - This allows power to be turned off to the load
- Power then feeds to the main breaker panel, the UPS input, or the traffic signal cabinet (depending on the purpose of the service)

Variations on service requirements will depend on local electrical codes.

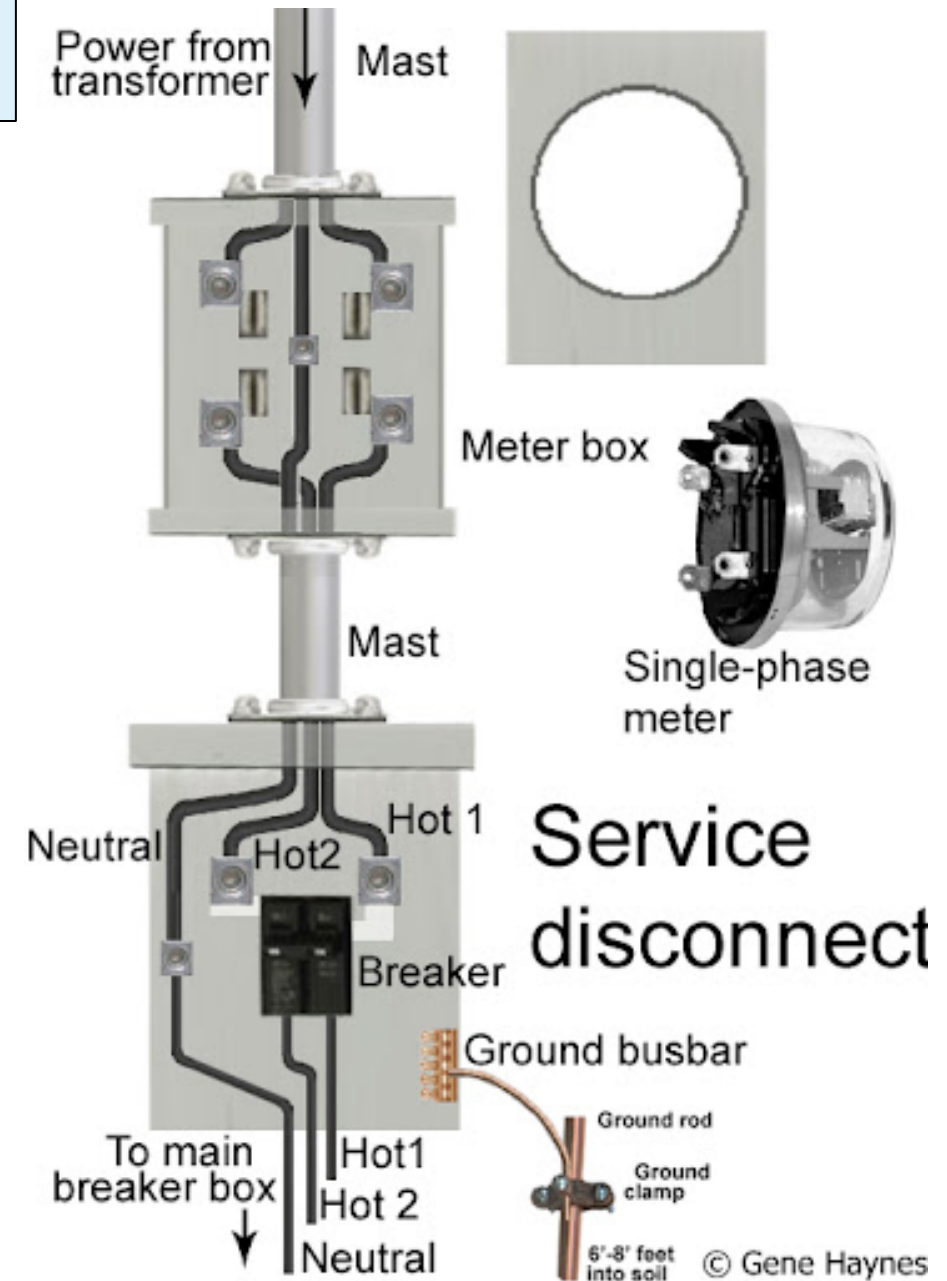

Knowledge Check:

When looking for the Current in an electrical circuit, which dial should you put your multimeter on?

- a) Voltage (V or E)
- b) Resistance (Ω or R)
- c) Amperage (A)
- d) Continuity ()

Knowledge Check:

What electrical property remains constant in a parallel circuit?

- a) Voltage
- b) Current
- c) Resistance
- d) Power

Knowledge Check:

What is the formula for Ohm's Law?

- a) $E = I \times R$ (Voltage = Current X Resistance)
- b) $P = I \times R$
- c) $R = E \times I$
- d) $I = E \times R$

Ohm's Law

$$E = I \times R$$

$$I = E / R$$

$$R = E / I$$

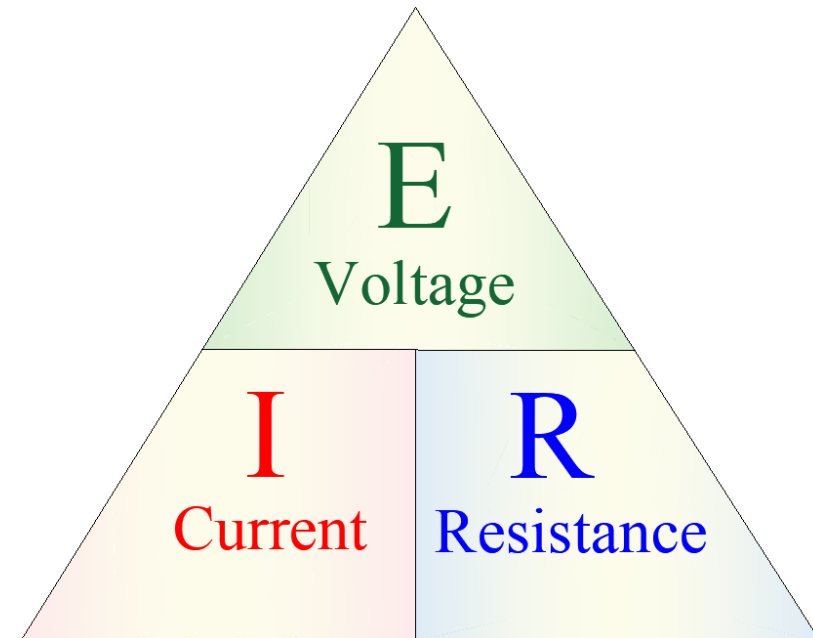

Knowledge Check:

DC current is a result of _____.

- a) voltage drop
- b) an alternator
- c) a motor
- d) a battery

Knowledge Check:

How are traffic signal indications typically wired in a circuit?

- a) In series
- b) In parallel
- c) In a star configuration
- d) In a combo (series/parallel) configuration

Knowledge Check:

How is the amount of power consumed by a circuit calculated?

- a) $P = E + I$
- b) $P = I \times E$ (Power = Current x Voltage)
- c) $P = E / I$
- d) $P = I \times R$

Power Formulas

$$P = I \times E$$

$$I = P / E$$

$$E = P / I$$

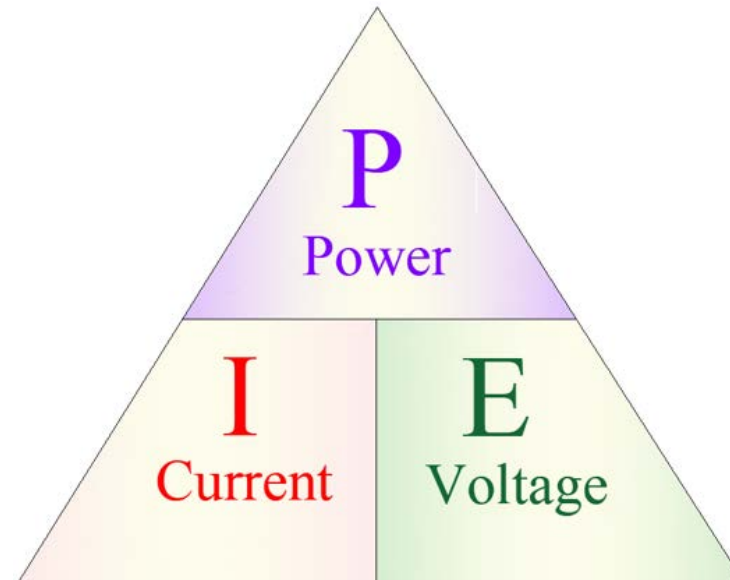

IMSA Traffic Signal Field Technician II

Session 3: Cabinets, Components and Configuration



Advancing the Future of Public Safety

Cabinet Types NEMA

A **NEMA TS-1** cabinet and controller interface via three MS-type connectors designated A, B, and C.

- The harness pins follow a designated configuration.
- A fourth D connector may be added to provide advanced features.

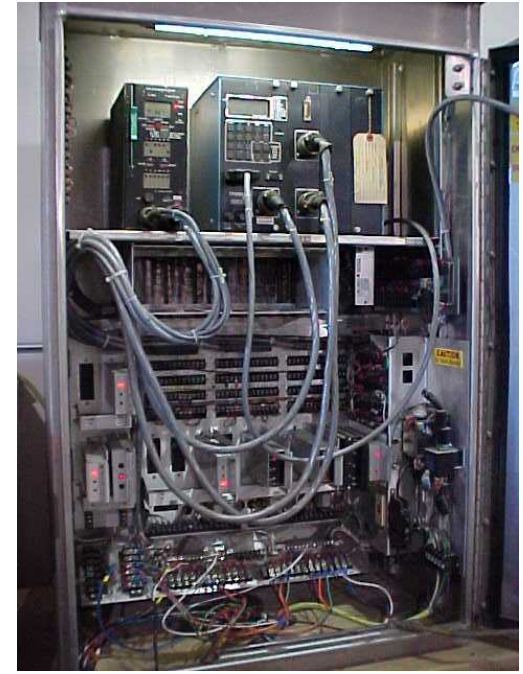

The **NEMA TS-2** cabinet uses an RS-232/SDLC data link connection to the controller, MMU, and peripheral devices.

- A TS-2 Type 1 controller has a separate power connector.
- The TS-2 Type 2 provides the same connectors as the TS-1 but also includes the data link connector.
- The NEMA TS-2 controller assembly uses a malfunction management unit (MMU).
- The TS-2 standard defines advanced traffic signal operations such as coordination and preemption and developed standards for pretimed operations and the cabinet.

Cabinet Types – Caltrans & ATCC

The **Caltrans type 170** cabinet is a hardware specification. Most type 170 cabinets are built the same way.

- Most cabinet equipment is rack mounted
- The first cabinets to have two doors (front & back)
- These cabinets use a conflict monitor
- Can use a type 170 controller or a 2070 controller



An **ITS (Intelligent Transportation System)** Cabinet provides ample space and convenient modularity for numerous applications. In addition to traffic control, the ITS cabinet is used for sign control and ramp meters.

- The **(ATCC) Advanced Transportation Control Cabinet** is an open architecture transportation control cabinet.
 - The ATCC is designed to control all types of traffic management applications
 - It is an ITS Cabinet intended to update or replace all cabinet types; NEMA TS-1, NEMA TS-2, and Caltrans.

Inputs vs. Outputs

No matter what type of cabinet or what specification they're built to, **EVERY** cabinet operates on the basic principle of "**inputs**" and "**outputs**."

- An **input** is an electronic or data signal **into a device**.
- The electronic signal is a voltage level, to include 120 VAC, 48 VDC, 24 VDC, 12 VAC, 12 VDC, 3 – 5 VDC
 - An active logic ground voltage level is 0 – 6 VDC
 - An inactive logic ground voltage level is 18 – 24 VDC
- These devices include: the controller, detection devices, load switches, and the monitor...
 - The purpose of these devices include; vehicle detection, ped detection, emergency vehicle preemption (EV), priority vehicle detection, railroad preemption (RR)...
- Data signals are made up of "packets" that contain "bits"
 - Data bits follow a binary system of "1's" and "0's"
 - BIU's & SIU's facilitate data communications throughout TS2 and ATC cabinets



Inputs vs. Outputs

No matter what type of cabinet or what specification they're built to, **EVERY** cabinet operates on the basic principle of "*inputs*" and "*outputs*."

- An **output** is an electronic signal **out of a device**.
- The electronic signal is a voltage level, to include 120 VAC, 48 VDC, 24 VDC, 12 VAC, 12 VDC, 3 – 5 VDC
 - An active logic ground voltage level is 0 – 6 VDC
 - An inactive logic ground voltage level is 18 – 24 VDC
- These devices include: the controller, load switches, and the monitor...
 - The purpose of these devices include; vehicle signal indications, overlap indications, ped signal indications, blank out signs...
- Data signals are made up of "packets" that contain "bits"
 - Data bits follow a binary system of "1's" and "0's"
 - BIU's & SIU's facilitate data communications throughout TS2 and ATC cabinets



Controller Inputs

Specific to the controller, **inputs** operate at three levels:

- Inputs per unit (controller), per ring, and per phase
- The level at which inputs are utilized are based on the controller specification; TS1, TS2, Caltrans, ATCC

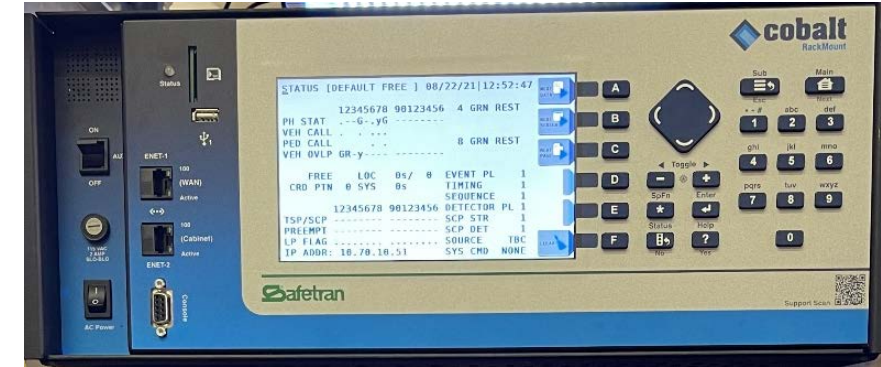

Inputs per unit include:

- AC voltage & ground
- Interval Advance
- Manual Control Enable
- External Start
- Vehicle Detectors (TS2 & ATCC)
- Ped Detectors (TS2 & ATCC)

Inputs per ring include:

- Force Off
- Stop Timing
- Red Rest
- Maximum II Select
- Pedestrian Recycle

Inputs per phase include:

- Hold
- Phase Omit
- Pedestrian Omit
- Vehicle Detectors (TS1)
- Pedestrian Detectors (TS1)

Controller Outputs

Specific to the controller, **outputs** operate at three levels:

- Outputs per unit (controller), per ring, and per phase
- The level at which outputs are utilized are based on the controller specification; TS1, TS2, Caltrans, ATCC



Outputs per unit include:

- 24 VDC & Logic Ground (TS1)
- Controller Voltage Monitor (CVM)
- Flashing Logic
- Load Switch Drivers for Overlaps (TS2)

Outputs per ring include:

- Coded Status Bits
- Coded status bits facilitate special engineering functions

Outputs per phase include:

- Load Switch Drivers
 - Vehicles
 - Pedestrians
- Phase "on"
- Phase "next"

Cabinet Components



NEMA type flasher

ATC flasher

Flasher: The flasher controls the flashing output to the traffic signals in the event of "manual" or "conflict" flash.

- The MUTCD mandates a flash rate of 50-60 times per minute
- NEMA/Caltrans flashers are dual circuits @ 15 amps each

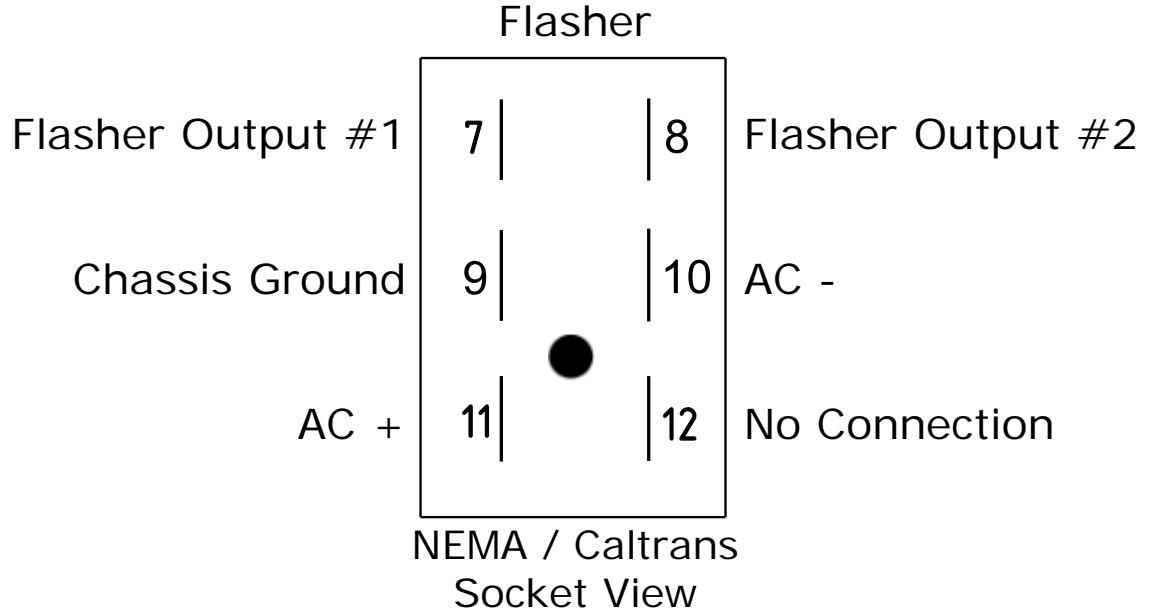

Cabinet Components



Load Switches / Load Packs: are interface devices in the cabinet that exist between the controller and the field signals.

- The controller sends a 24/0 VDC output to the load switch
- The load switch sends a 120 VAC output to the appropriate signals
- **NEMA** load switches have 3 circuits rated at 25 amps ea.
 - Red/Don't Walk, Yellow, & Green/Walk
- Load switches are also called "*Switch Packs*" in type 170 cabinets

Cabinet Components

One inherent problem with NEMA type load switches is that they leak voltage due to the design of the output circuits.

- Therefore, unused load switch outputs require something to bleed off the leakage voltage.
- A common practice is to use a "bleed-off" or "pull-down" resistor connected between the field terminal and AC-.

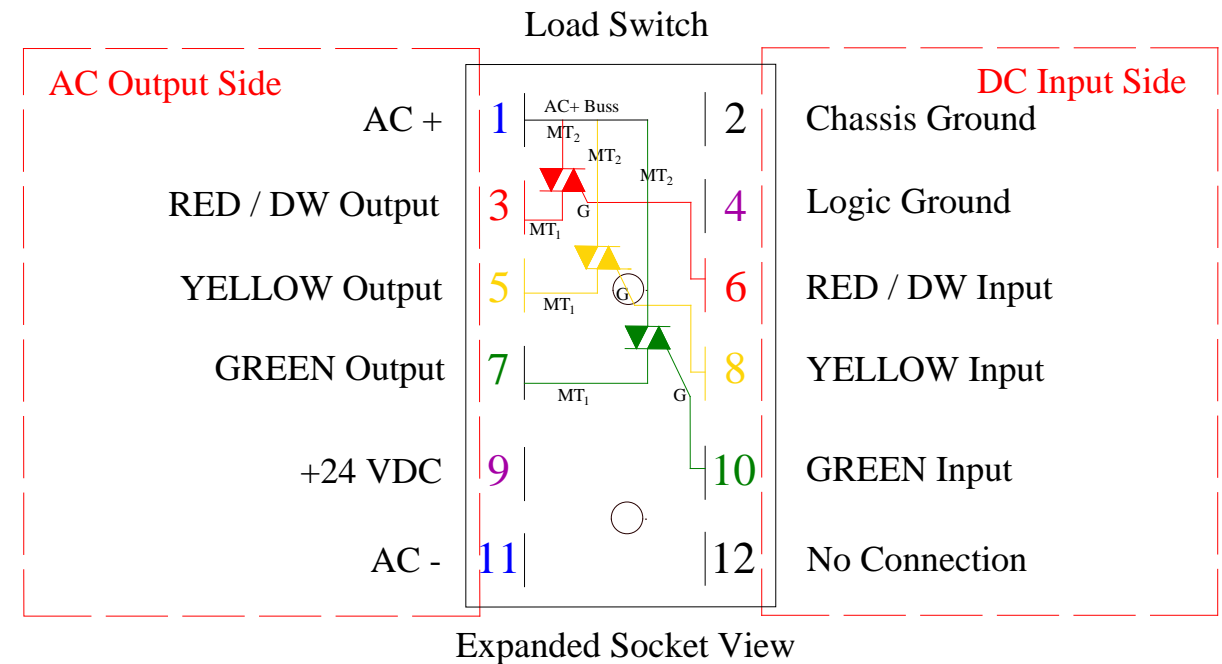

Cabinet Components



The aforementioned load switch was redesigned for the **ATC** cabinet as a **High-Density Switch Packs (HDSP)**.

- HDSP's are designed to be used with LED signal indications only.
- Card mounted design to be installed in a slot in an output assembly.
- Each HDSP has two channels with three outputs each; Red/Don't Walk, Yellow, & Green/Walk for a total of 6 outputs.
- The HDSP can also double as the flasher unit in ATC cabinets.
- Each HDSP communicates directly with the cabinet monitor unit (CMU) through serial bus 3
- The HDSP monitors current on each output which is then reported directly to the cabinet monitor unit.
- Leaky voltage from traditional load switches is no longer a problem.

Cabinet Components



ATC - High-Density Switch Pack (HDSP)

DIN 41612, Type E,
48-pin Connector

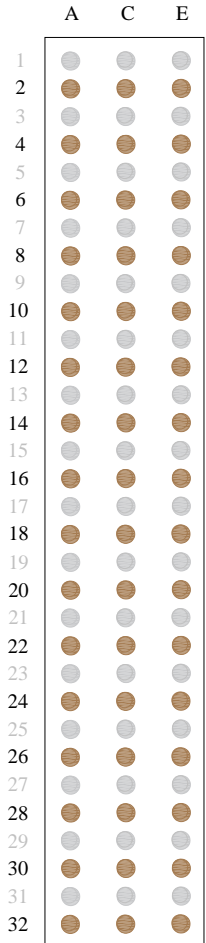

High-Density Switch Packs (HDSP): The HDSP was redesigned for the ATC cabinet.

- Three rows of 16 pins each

Pin	A (Bottom)	C (middle)	E (Top)
2	Ch 1 RED in	Ch 1 YELLOW in	Ch 1 GREEN in
4	Ch 2 RED in	Ch 2 YELLOW in	Ch 2 GREEN in
6	+24 VDC	DC Ground	Address 4
8	Equipment Ground	Neutral	Neutral
10	SB #3 Rx+	SB #3 Tx+	Address Common
12	SB #3 Rx-	SB #3 Tx-	Address 3
14	Address 0	Address 1	Address 2
16	Ch 1 RED Sense	Ch 1 RED Out	Ch 1 RED Out
18	Ch 1 YELLOW Sense	Ch 1 YELLOW Out	Ch 1 YELLOW Out
20	Ch 1 GREEN Sense	Ch 1 GREEN Out	Ch 1 GREEN Out
22	Ch 2 RED Sense	Ch 2 RED Out	Ch 2 RED Out
24	Ch 2 YELLOW Sense	Ch 2 YELLOW Out	Ch 2 YELLOW Out
26	Ch 2 GREEN Sense	Ch 2 GREEN Out	Ch 2 GREEN Out
28	LV+ Signal	LV+ Signal	LV+ Signal
30	HV + Signal	HV + Signal	HV + Signal
32	LV + Mains	Neutral	HV + Mains

Cabinet Components



ATC - High-Density
Flasher Unit (HDFU)

DIN 41612, Type E,
48-pin Connector

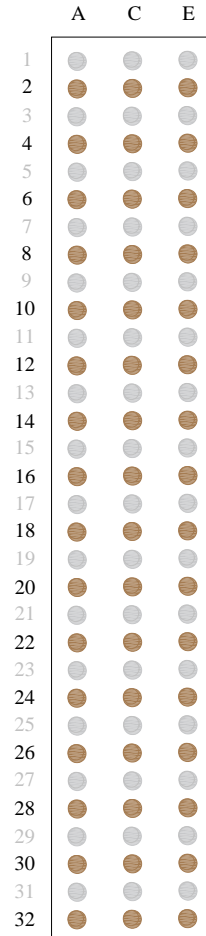

High-Density Flasher Units (HDFU):
The HDSP doubles as a flasher unit in the ATC cabinet.

Pin	A (Bottom)	C (middle)	E (Top)
2	Reserved	Reserved	Ch 1 Aux in
4	Ch 2 Aux in	Reserved	Reserved
6	+24 VDC	DC Ground	Address 4
8	Equipment Ground	Neutral	Neutral
10	SB #3 Rx+	SB #3 Tx+	Address Common
12	SB #3 Rx-	SB #3 Tx-	Address 3
14	Address 0	Address 1	Address 2
16	Fl #1-1 Sense	Fl #1-1 Out	Fl #1-1 Out
18	Fl #1-2 Sense	Fl #1-2 Out	Fl #1-2 Out
20	Ch 1 Aux Sense	Ch 1 Aux Out	Ch 1 Aux Out
22	Ch 2 Aux Sense	Ch 2 Aux Out	Ch 2 Aux Out
24	Fl #2-1 Sense	Fl #2-1 Out	Fl #2-1 Out
26	Fl #2-2 Sense	Fl #2-2 Out	Fl #2-2 Out
28	LV+ Signal	LV+ Signal	LV+ Signal
30	HV + Signal	HV + Signal	HV + Signal
32	LV + Mains	Neutral	HV + Mains

Cabinet Components

Flash Transfer Relays – FTR’s switch control of the RED or YELLOW load switch output and the flasher output to the appropriate signal indications in the field.

- These are the devices that switch the signals between normal operation and flashing operation.
- Each relay controls two vehicle phases.
- The coils are energized in a NEMA / ATC cabinet during normal operation.
- The coils are de-energized in a Type 170 cabinet during normal operation.
- ATC relays (below right) have a smaller design and are hermetically sealed with dry nitrogen to keep out debris and bugs.
 - Contacts are rated between 10 to 30 amps, depending on the relay
- Newer relays have an LED light, which indicates the status of the coil as energized

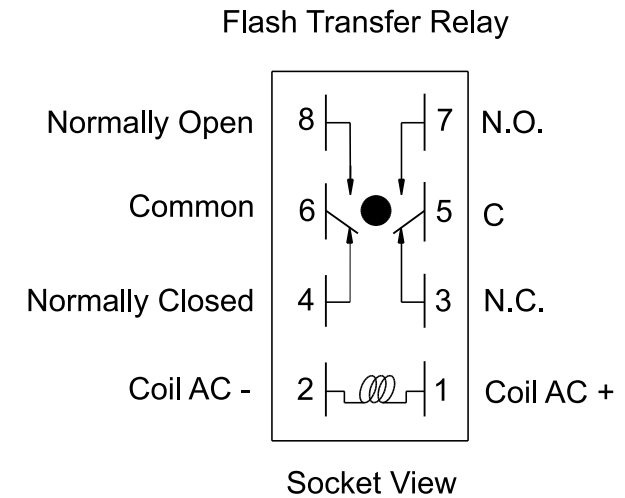

Cabinet Components

Bus Interface Unit – BIU: (*TS-2 cabinets*)

The “BIU” provides a communication interface between the controller and external devices, such as:

- The MMU (malfunction management unit)
- The terminal facilities (load switch bay)
- The detector rack
- Any specialized shelf-mounted equipment
- This bus operates at 153,600 bits per second

The BIU is based on an **SDLC** (Synchronous Data Link Control) communication protocol.

Communications are conducted through a 15-pin “D”-type connector.

- This is how the controller communicates with the external devices.



Cabinet Components

Serial Interface Unit – SIU: (*ATC cabinets*)

The “SIU” provides a communication interface between the Advanced Transportation Controller (ATC) and serial bus #1 and serial bus #2:

- Serial Bus #1 facilitates data exchange between the controller unit, the input & output functionalities, and the CMU
- Serial Bus #2 is not yet assigned
- Serial Bus #3 facilitates communications between the CMU, the HDSP/FU, and the ADU
 - Serial Bus #3 interfaces via a RJ-45 and communicates with EIA-485 standards

While the form factor between the BIU and the SIU may look alike, but these are two very different units and **are not interchangeable**.

- SIU’s communicate 4 times faster than BIU’s at a rate of 614,400 bits per second



Cabinet Components



External Power Supply: (*NEMA*)

The power supply provides regulated AC & DC voltages for the BIU's, load switches, and detectors within the cabinet.

Voltages include:

- 12 VAC
- 12 VDC
- 24 VDC
- Line frequency reference within the cabinet

As per the NEC, ensure the ground and neutral are bonded together at the power source, which may be the electrical service or power terminal block in the cabinet.

Cabinet Components



Detector Rack or Input Files: (type 170/ATC)

The Detector Rack provides housing and circuitry to detection devices (e.g., detector cards), which are sensors that detect the presence of vehicles, pedestrians, or bicycles, which then sends input signals to the controller. Detectors include:

- Loop detectors
- Video detectors
- Radar detectors
- Magnetometer detectors
- Emergency Vehicle Preemption (EVP)
- Railroad preemption
- **252 AC & 242 DC isolators**



Cabinet Components



Battery Backup System / UPS (Uninterruptable Power Supply):

The battery backup system can provide enough power to the traffic signals to keep them running for a certain amount of time in case of power outages. Many agencies require enough backup power for either:

- 2 hours of normal operation followed by 4 hours of flashing operation OR
- 8 hours of flashing operation

Battery backups may be found in the cabinet or in a small closet attached to the cabinet.



Cabinet Components



Detection Panel:

The field wires for the loops, magnetometers, magnetic detectors, pedestrian push buttons, and the emergency vehicle preemption detectors terminate on this panel.

The panel is wired directly to the detector rack, where the detectors process the input signals from the field.

The detectors in turn send an output to the controller indicating the need for service on any given phase(s).

Cabinet Components

Field Terminals:

The field terminals are the interface between the signal indications in the field and the various electrical components in the cabinet.

All the traffic signal indications in the field terminate on the lower side of these terminal strips.

The upper side of the terminals connect to the load switch outputs, the FTR's and the conflict monitor/MMU inputs.

It is a good practice to ensure that all field wires are labeled according to the phase(s) and direction(s) they serve.

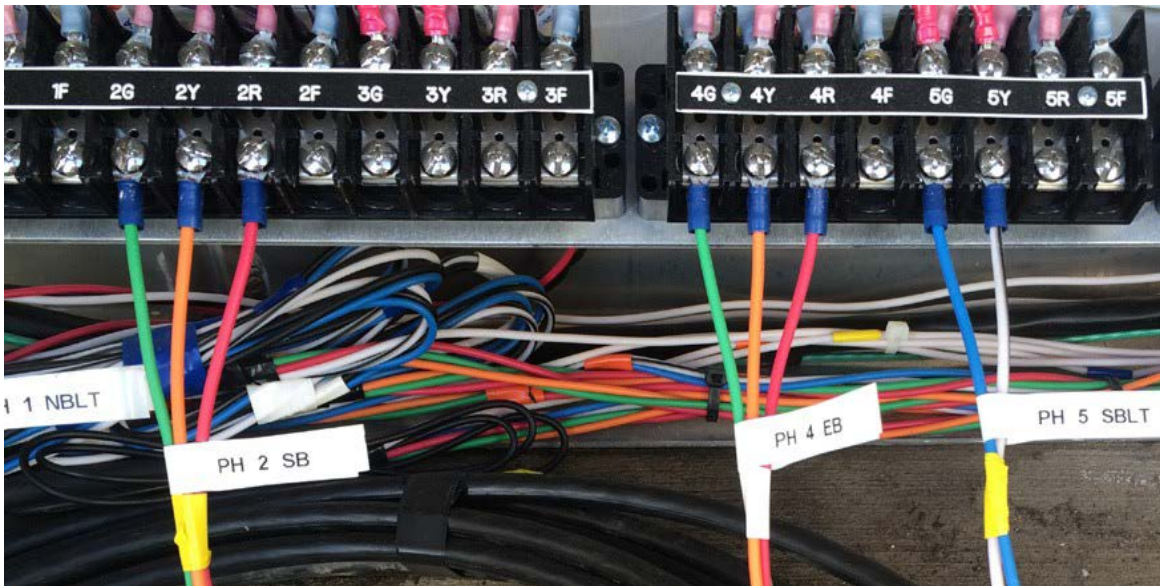

Cabinet Components



Power Panel: The power panel is responsible for the power input into the traffic signal cabinet. The power panel contains the power supply lines from the local electric company, various circuit breakers, bus bars for earth ground, logic ground and AC-, surge protectors to protect from current overload and the mercury contactor/Solid State Relay (SSR).

- *Logic ground in NEMA TS-1 and Type 170 Cabinets is isolated from the earth ground and the AC-*



GFCI: A Ground Fault Circuit Interrupter is a fast-acting circuit breaker designed to protect from electrical shock by shutting off electric power in the event of a ground fault.

- Never plug cabinet equipment into the GFCI due to false interruptions in electrical supply caused by electrical surges.

Cabinet Components

(CMU/MMU) Conflict Monitor Unit / Malfunction Management Unit:

The CMU/MMU displays the status of the intersection and is responsible for responding to malfunctioning signals and operating voltages.

MMU/CMU manufacturers as well as the "Traffic Signal Maintenance Handbook" recommend that monitors be tested and certified annually.

In the case of a fault, the monitor displays:

- ***"What"*** the problem was by showing the corresponding fault
- ***"Where"*** the problem occurred by showing the affected channel(s)



Cabinet Components



CMU/MMU:

NEMA TS-1 (types 3, 6, 12, 18) CMU's have four inputs per channel:

- Green, Yellow, Red, & Walk

Type 170 CMU's have three inputs per channel:

- Green, Yellow, & Red

NEMA TS-2 MMU's (type 16) and ATCC cabinet monitor units have three inputs per channel:

- Green/Walk, Yellow, & Red/Don't Walk

A channel is deemed active if the voltage threshold level is:

- >60 VAC on the Red channel (Red is not considered a conflict)
- >25 VAC on the Yellow and Green channels

Line voltages greater than 98 VAC will allow normal signal operation. Line voltages less than 89 VAC will not allow the signal to run.

24 VDC thresholds - >22 VDC is adequate for normal signal operation. <18 VDC will not allow the signal to run.

Cabinet Components



Controller:

The controller is the central computer in the cabinet responsible for the operation of the traffic signal at an intersection. It processes detection inputs from various devices and internal settings to determine when and how to change the traffic signals.

- Inputs come from vehicle detection devices, pedestrian buttons, emergency vehicles, railroad, internal recalls, time-of-day, and coordination programs.
- The controller processes these inputs, the ring diagram, and programmed configuration settings to determine the order of what to do next.
- The controller sends the appropriate outputs to the load switches, which in turn lights up the signals in the field.



Controller Components

The traffic signal controller typically consists of the following components:



<https://www.cubic.com/transportation/products>

Central Processing Unit (CPU): This is the brain of the controller, responsible for executing the control algorithms and coordinating the overall operation of the traffic signals.

Input/Output (I/O) Modules: These modules facilitate communication between the controller and various external devices. They receive inputs from sensors such as vehicle detectors, pedestrian push buttons, and cameras, and provide outputs to control the traffic signal indications.



Controller Components



<https://www.orangetraffic.com/>

Timing and Control Algorithms: The controller utilizes pre-programmed timing plans and algorithms to determine when and how the traffic signals change.

These algorithms take into account factors such as traffic volumes & demands, pedestrian demands, and coordination with adjacent intersections.

Communication Interfaces: Traffic signal controllers often have communication capabilities to interact with a central traffic management system. This allows for remote monitoring and control of the signals, enabling adjustments based on real-time traffic conditions or emergencies.

Power Supply: The controller requires a stable power source to operate reliably.

The circuit boards may have built-in or replaceable batteries to maintain the internal time and date information.



<https://hotcore.info/babki/traffic-signal-controller.htm>

Controller Database

A controller database stores the intersections library of available timing and operational configurations to be implemented by data received locally or by means of a central system.

The components of a **traffic signal timing database** typically include:

- **Timing Parameters:** This component defines the specific timing parameters for each signal and ped phase, such as the green, yellow, red, walk (shall be 7 seconds minimum), and don't walk intervals. These timings determine how long each phase lasts, ensuring efficient traffic flow.
- **Start Up Programming:** This programs the sequence by which the controller will start up once engaged for normal operation. It determines which phases will begin and in what condition, i.e., Red, Yellow, Green.

Controller Database

The components of a **traffic signal timing database** typically include:

- **Ring Configuration & Phase Sequence:** This portion of the data base determines the active phases to be used and the sequence in which the phases will be serviced. These settings can be changed by time-of-day programming to accommodate differing traffic volumes and flows.
- **Overlap data:** This assigns the overlap parent phase(s), overlap timing and output channels.
- **Cabinet I/O:** The controller maintains the input and output assignments throughout the cabinet to include the detector mapping and special output assignments such as flashing beacons and blank out signs.
- **Logic Processor:** The logic processor facilitates special logic statements to be written for specific configuration or timing needs at an intersection.

Controller Database

The components of a **traffic signal timing database** typically include:

- **Coordination Data:** Traffic signals are often coordinated to create a green band of synchronized green lights along a road corridor to promote uninterrupted progression. The coordination data component stores information on cycle lengths, offsets, splits, or force offs, which are used to achieve optimal traffic progression and reduce congestion.
- **Time-of-Day Plans:** Traffic patterns change throughout the day. Therefore, traffic signal controllers can change the signal timing, coordination, ring sequence, and phasing based on the traffic conditions at any given time of the day.
- **Special Events and Emergency Plans:** The database may include provisions for special event or emergency plans, allowing traffic engineers to modify signal timings temporarily to accommodate unique traffic scenarios. This ensures flexibility and efficient management during unexpected situations.

Controller Database

The components of a **traffic signal timing database** typically include:

- **Preemption and Priority Control:** These settings determine the phase(s) to be preempted due to the approach of an emergency vehicle or a railroad. It also determines the allowable phases to be serviced during the call and the exit phases to be serviced once the emergency vehicle departs.
 - Priority control allows special signal consideration for public transit vehicles.
- **Communication Protocols:** The database may incorporate communication protocols that facilitate data exchange between the traffic signal timing system and other operational systems, such as traffic management centers or Intelligent Transportation Systems (ITS) platforms. These protocols enable the system to receive real-time data and send commands for updating signal timings.

Timing Sheets

A timing sheet, also often referred to as a signal timing plan, is a crucial component in the management of traffic signals. It provides the detailed settings and operational parameters that govern how a particular traffic signal or intersection operates. Timing sheets are a paper copy of the controller database and issued by the traffic engineer.

Key components of a **traffic signal timing sheet** may include:

- **Cycle Length:** The cycle length is a complete sequence of signal indications. This includes the phases for all directions and any pedestrian signals.
- **Phase Times:** Phase times represent the various timing intervals within a cycle where a specific movement or set of movements is given the right of way. Each phase is assigned specific times across many timing intervals.

Timing Sheets

Key components of a **traffic signal timing sheet** may include:

- **Ring Configuration:** Sets the order by which the phases will be serviced during any given cycle.
- **Offset:** The offset is the amount of time from when a cycle starts to when the main street green starts. This parameter is important for coordinating multiple intersections along a corridor.
- **Split:** The split refers to the amount of green time given to each phase within a coordinated cycle length.
- **Clearance Intervals:** These intervals include the yellow, all-red, and flashing don't walk intervals for a phase to provide a buffer and allow the intersection to clear before the next conflicting phase(s) begins.

Timing Sheets

Key components of a **traffic signal timing sheet** may include:

- **Walk and Pedestrian Clearance Times:** These times are specifically for pedestrian signals. The walk time is when pedestrians are displayed the "Walk" symbol, and the pedestrian clearance time is when the "Flashing Don't Walk" symbol is shown.
- **Detector Settings:** If the intersection has vehicle detection, the settings for these detectors would be specified, including what they are used for (e.g., to extend green time, call a phase, etc.)

The timing sheet is essential for several reasons. It determines the efficiency of an intersection or a series of intersections affecting travel times, vehicle stops, and, to some degree, fuel consumption. A well-optimized signal timing can significantly reduce traffic congestion and improve overall traffic flow.

Rings and Barriers

Ring - NEMA defines a ring as:

“A ring consists of two or more sequentially timed and individually selected conflicting phases so arranged as to occur in an established order”.

- Each ring is sequentially timed which means phases in the same ring will *NEVER* be compatible, i.e., always “conflicting”.

Barrier - Otherwise known as a “compatibility line” is defined by NEMA as:

“A reference point in the preferred sequence of a multi-ring controller in which all rings are interlocked.”

- Which means the rings must work together by crossing the barrier at the same time
- Phases on one side of the barrier will never operate with phases on the other side of the barrier

8-Phase Ring & Channel Compatibility

An 8-phase traffic signal controller is designed to manage traffic movements at an intersection with eight distinct phases or combinations of traffic movements. Each phase represents a specific set of movements that are allowed or restricted by the ring diagram.

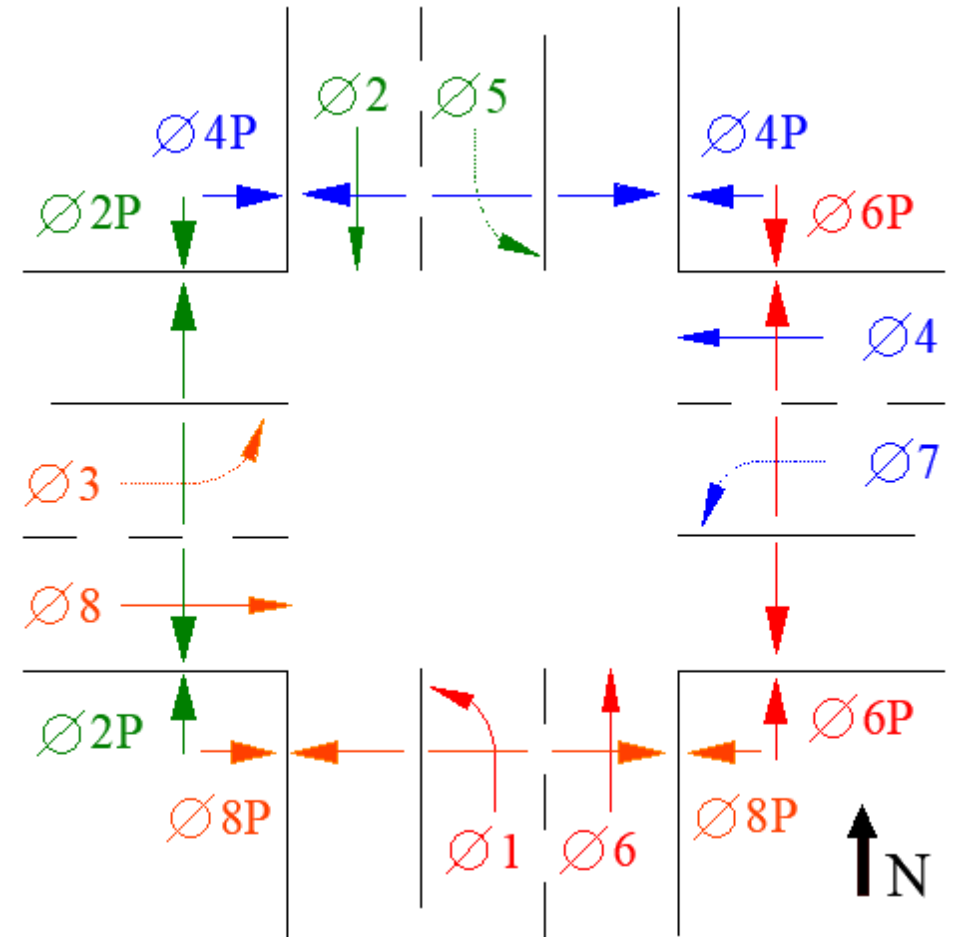
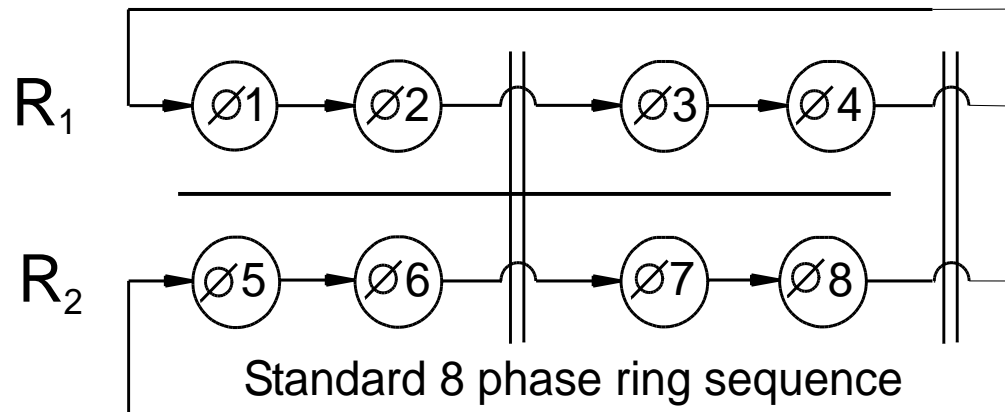

Overlaps

Overlaps:

- A **GREEN** indication that allows a movement of traffic to flow during the GREEN and clearance intervals of one or more phases.
- The overlap must work within the ring diagram to avoid conflicts and may be displayed as such for channel compatibility.
- There are two types of overlaps:
 - *“Parent / Child”*
 - *“Independent”, “Timed Overlaps” or “Double Clearance”*

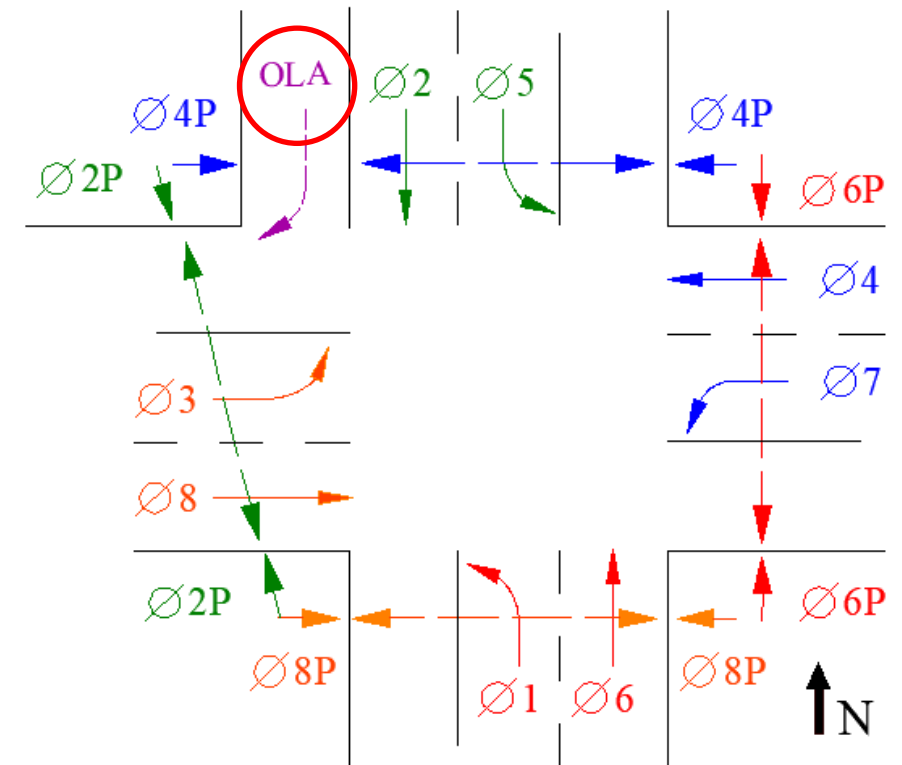
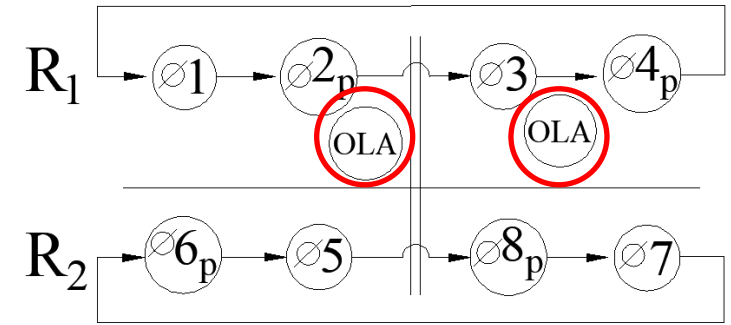

OLA Depicts FYA or delayed green

“Parent / Child” Overlaps

Two types of Overlaps:

- The overlap indication begins with one phase and terminates with another phase.
- In this case, the overlap “A” (the child) is controlled by phases 2 and 3 (the parents).

1. Phase 2 begins timing GREEN/
Overlap A goes GREEN
2. Phase 2 times YELLOW clearance/
Overlap A stays GREEN
3. Phase 2 times RED clearance/
Overlap A stays GREEN
4. Phase 3 begins timing GREEN/
Overlap A stays GREEN
5. Phase 3 times YELLOW clearance/
Overlap A turns YELLOW
6. Phase 3 times RED clearance/
Overlap A turns RED

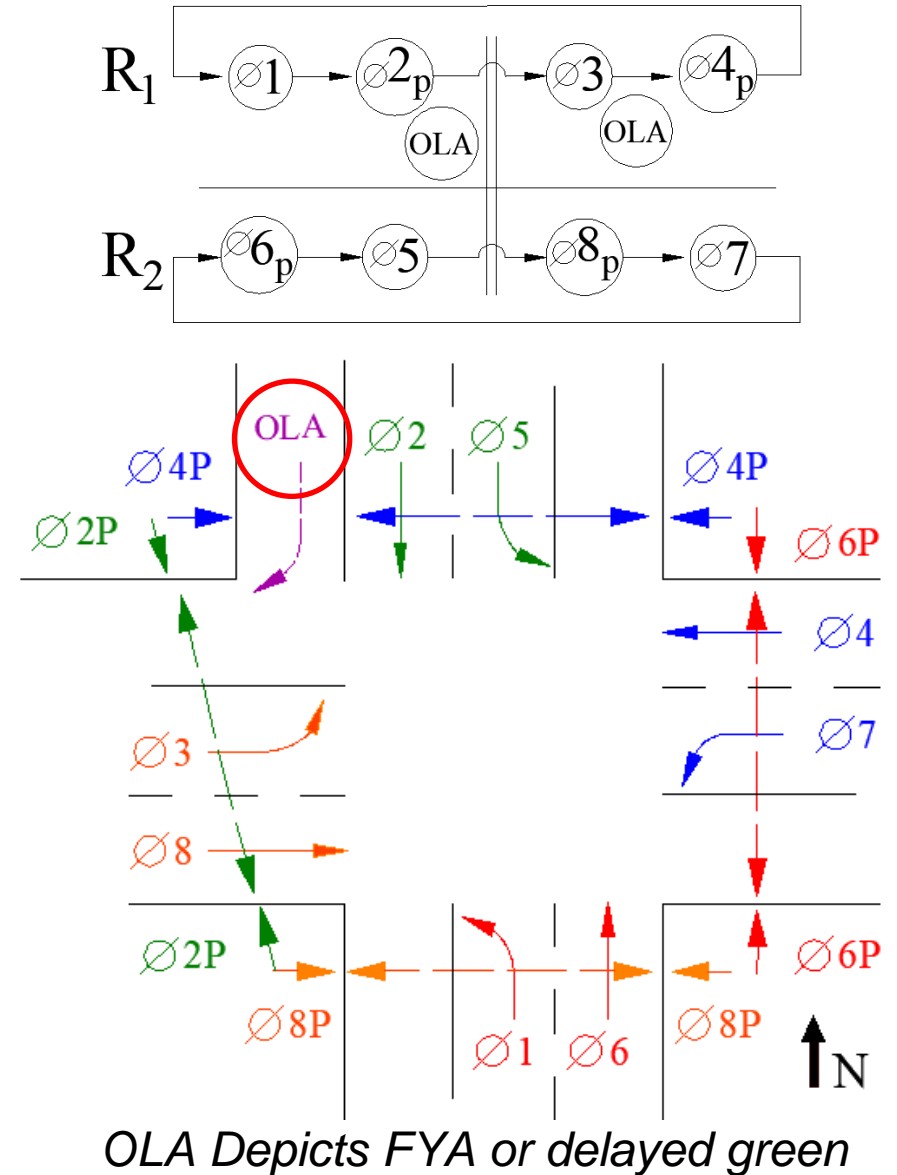

“Independent”, “Timed”, or “Double Clearance” Overlaps

Two types of Overlaps:

- The overlap indication begins with one phase but does not terminate with the other phase
- This overlap has its own timing parameters
- In this case, the overlap “A” (the child) is controlled by phases 2 and 3 (the parents)...**however**,
 1. Phase 2 begins timing GREEN/ Overlap A goes GREEN
 2. Phase 2 times YELLOW clearance/ Overlap A stays GREEN
 3. Phase 2 times RED clearance/ Overlap A stays GREEN
 4. Phase 3 begins timing GREEN/ Overlap A stays GREEN
 5. Phase 3 times YELLOW clearance/ Overlap A begins timing its GREEN time
 6. Phase 3 times RED clearance/ Overlap A continues timing its GREEN time
 7. Overlap then times its YELLOW and RED clearance times

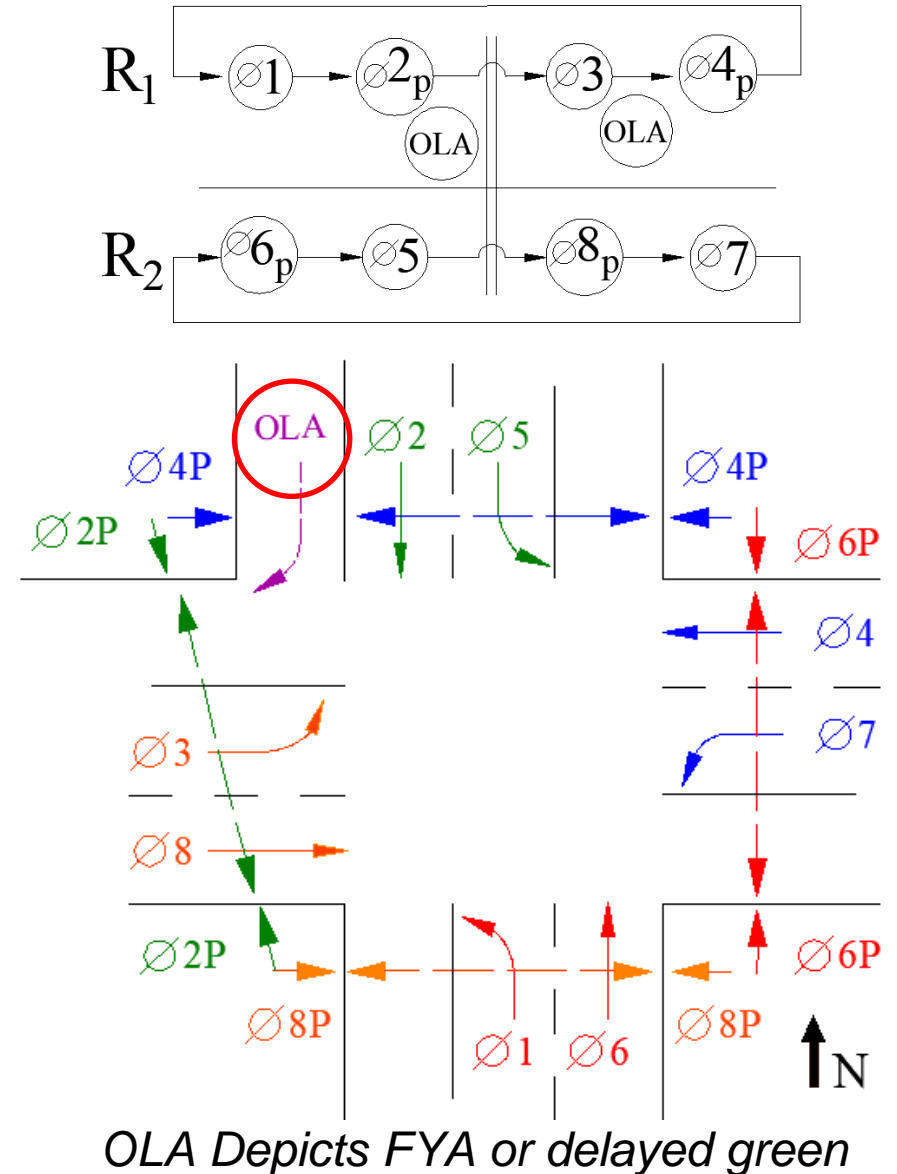

In the IMSA Traffic Signal Tech I presentation, we discuss protecting pedestrians crossing the street from traffic by eliminating the conflicting movements that may cross their path.

It's a little more complicated than that with today's controller & cabinet architecture.

- *Everything is assigned to its own channel which must be considered when programming the monitor for compatibility.*
- Standard NEMA channel/phase assignments are:
 - Channels 1 – 8 are vehicle phases 1 thru 8
 - Channels 9 – 12 are ped phases 2, 4, 6, & 8
 - Channels 13 – 16 are overlaps A, B, C, & D

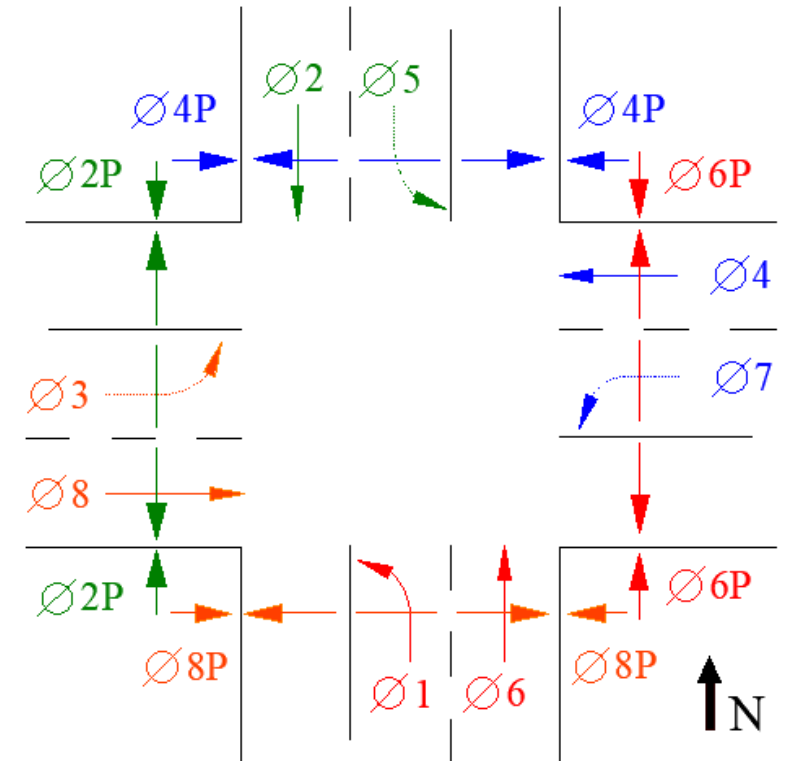
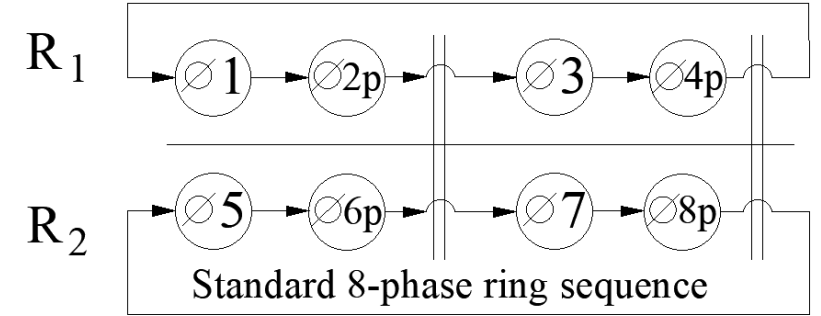

Traffic Signal Operation Theory

Pedestrian Channels

- Standard 170 channel/phase assignments are:
 - Channels 1 – 8 are vehicle phases 1 thru 8
 - Channels 9 – 12 are overlaps A, B, C, & D
 - Channels 13 – 16 are ped phases 2, 4, 6, & 8
- In this diagram, the circled pedestrian movement must cross with vehicle Ø2.
- The normal vehicle channel pairs would be: 2-5, & 2-6
- The additional **NEMA** channel pairs just for this **one** ped movement would be: 2-9, 5-9, 6-9, & 9-11
- The additional **170** channel pairs would be: 2-13, 5-13, 6-13, & 13-15

Change channel assignments or add more channels and the compatibility programming becomes more complicated.

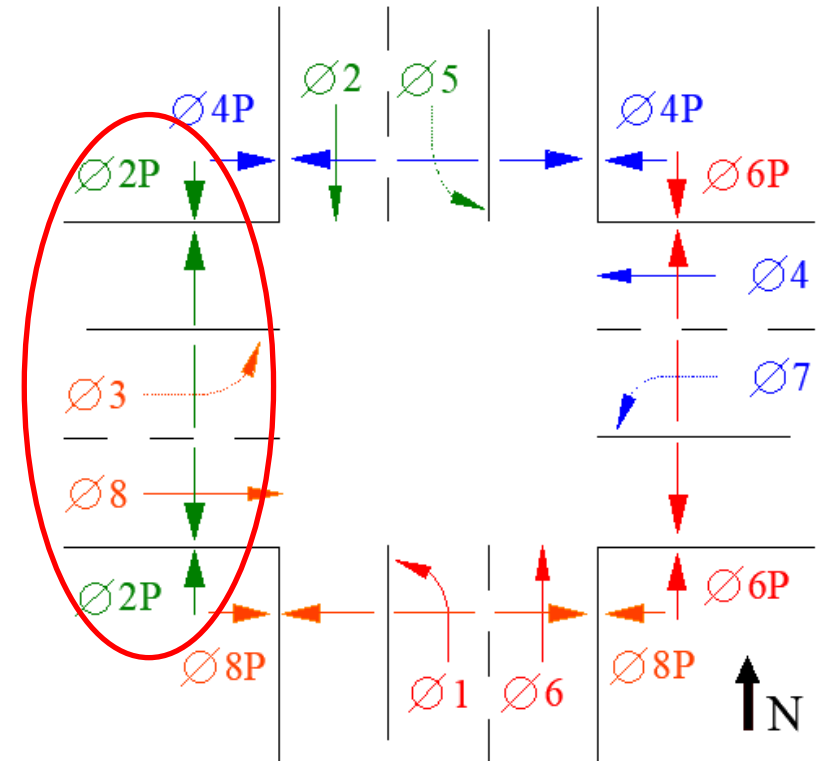
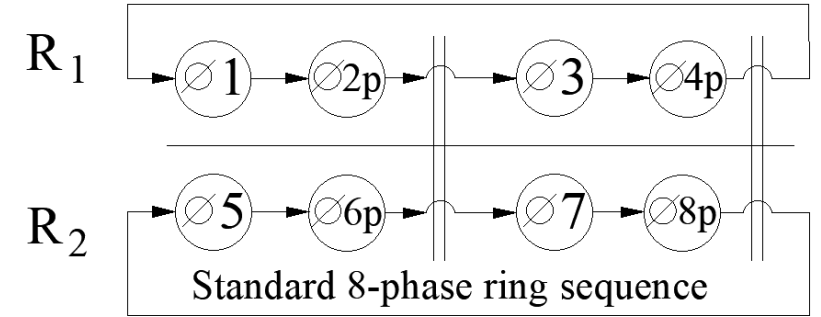

Traffic Signal Operation Theory Pedestrian Channels

Now consider the entire intersection with 8 vehicle phases with 4 ped movements:

- The normal vehicle channel pairs would be:
1-5, 1-6, 2-5, 2-6, 3-7, 3-8, 4-7, 4-8
- The additional **NEMA** channel pairs for *all* the ped movements would be:
1-11, 2-9, 2-11, 5-9, 6-9, 6-11, 9-11, 3-12, 4-10, 4-12, 7-10, 8-10, 8-12, & 10-12
- The additional **170** channel pairs for *all* the ped movements would be:
1-15, 2-13, 2-15, 5-13, 6-13, 6-15, 13-15, 3-16, 4-14, 4-16, 7-14, 8-14, & 8-16

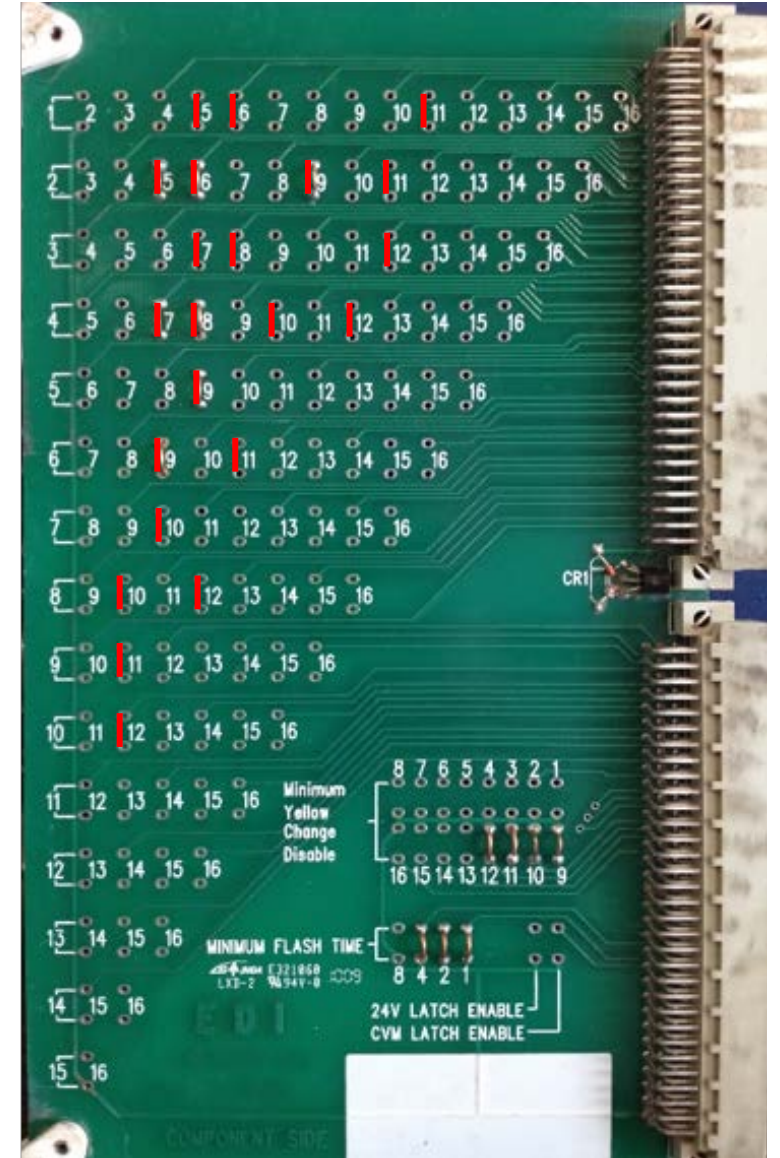
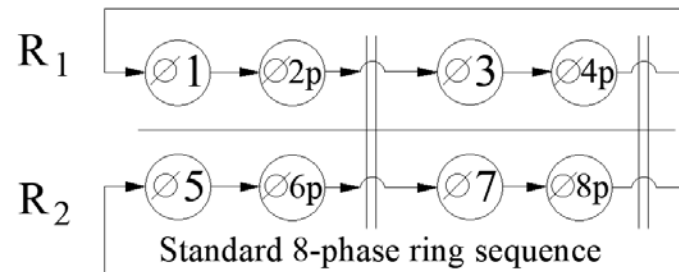

Let's add an overlap to the existing intersection:

- Remember, an overlap is a green indication for a movement of traffic that is controlled by one or more vehicle phases.
- Overlaps are typically lettered – A, B, C, & D
- **NEMA** overlap channels – 13, 14, 15, & 16
 - 2-13, 5-13, 6-13, 11-13, 3-13, 7-13, 8-13, & 12-13
- Type **170** overlap channels – 9, 10, 11, & 12
 - 2-9, 5-9, 6-9, 9-15, 3-9, 7-9, 8-9, 9-16, & 14-16

*For Flashing Yellow Arrow or Delayed Green.
Channels **9-13** are a conflict with the use of a green arrow.*

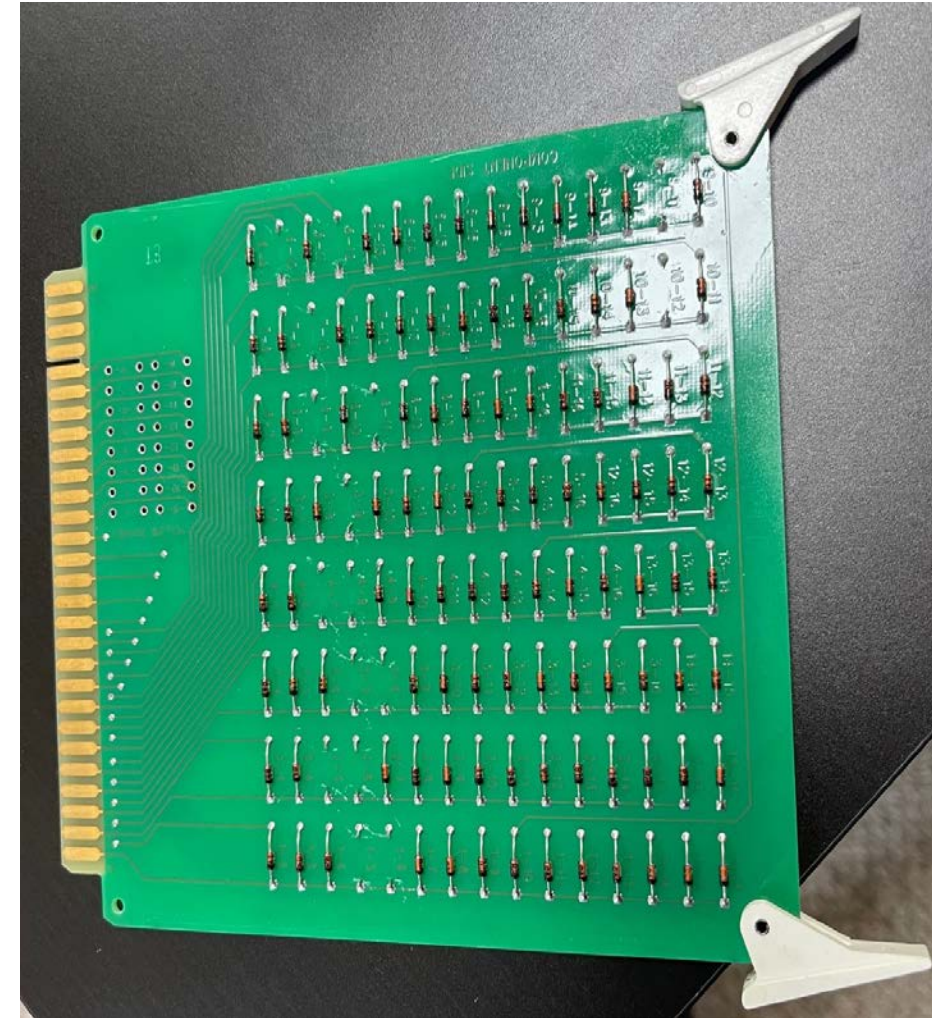

Let's add an overlap to the existing intersection:

- **NEMA** overlap channels – 13, 14, 15, & 16
 - 2-13, 5-13, 6-13, 11-13, 3-13, 7-13, 8-13, & 12-13
- Type **170** overlap channels – 9, 10, 11, & 12
 - 2-9, 5-9, 6-9, 9-15, 3-9, 7-9, 8-9, 9-16, & 14-16

*For Flashing Yellow Arrow or Delayed Green.
Channels **9-13** are a conflict with the use of a green arrow.*

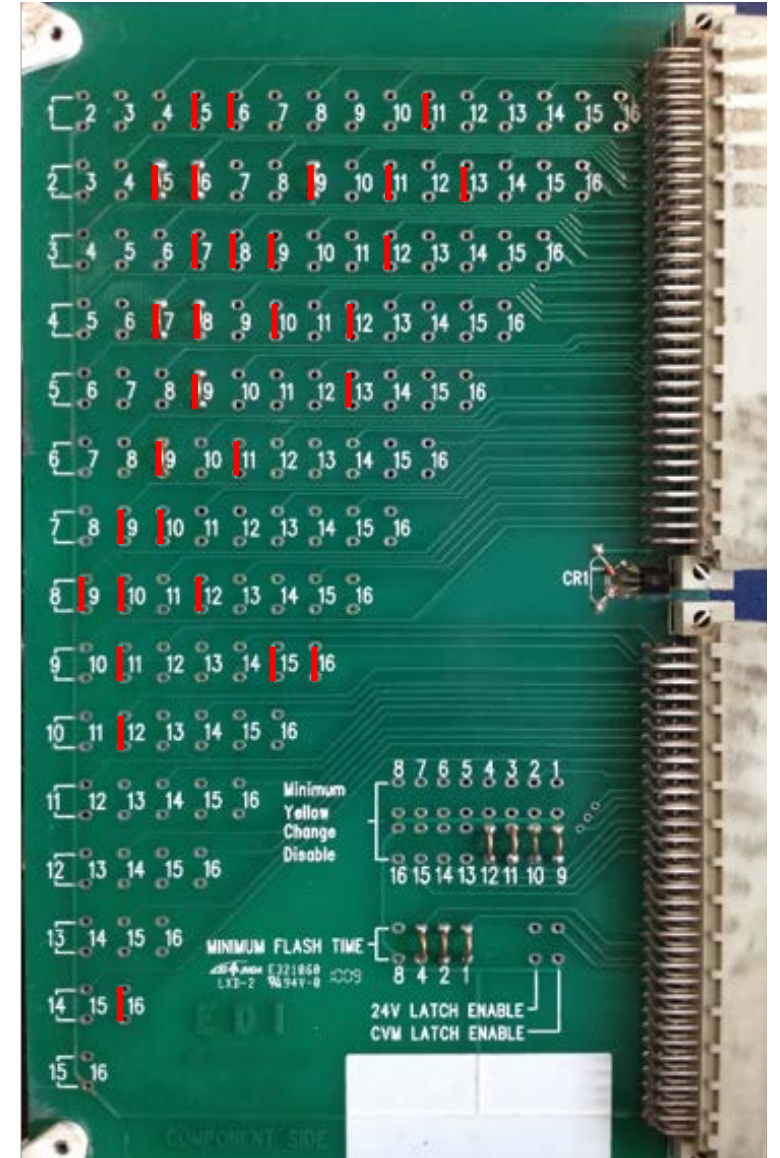

Cabinet Configuration

Traffic signal techs must configure new cabinets and test them prior to deploying them in the field.

- New cabinets are shipped without any equipment installed:
 - **Configuration means to set up the cabinet for the specific intersection it will run**
 - Physically check factory wire terminations and terminal screws for connection integrity.
 - Install load switches in the appropriate sockets matching the phases/channels to be used
 - **Unused** vehicle and overlap channels need to be loaded with 120 VAC on the RED to satisfy the monitor.
 - The easiest way to do this in a NEMA cabinet is to jumper L.S. socket pins #1 to #3, however this may not be as secure due to vibrations on the cabinet.
 - Install a conductor between the RED field terminal and a 120 VAC source in the cabinet. This is far more secure because it's a physical connection.
 - In a type 170 cabinet: Move the red monitor jumpers to the AC+ position on the red monitor board in the back of the cabinet.

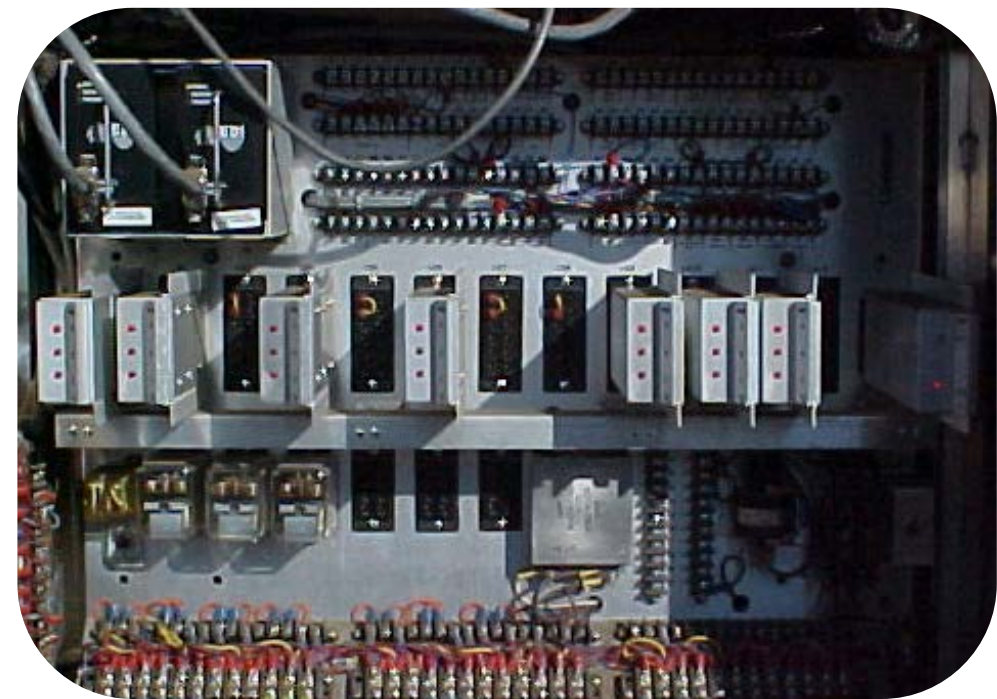
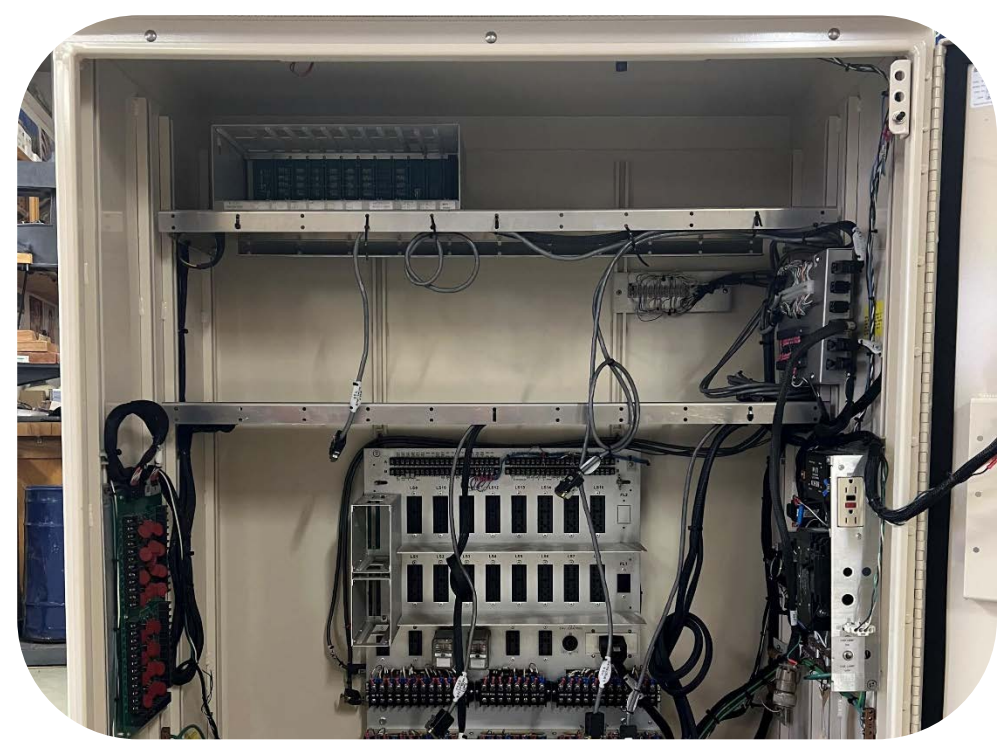

Cabinet Configuration

Flashing Yellow Arrows (FYA):

- FYA's are typically configured in two ways:
 - The FYA output is taken from the unused opposing ped yellow on the load switch while the R, Y, & G is connected to load switch for the left turn phase.
 - The R, Y, & FYA are connected to the load switch for the left turn phase, while the G is tied to a green output of an overlap channel.
- Either way requires programming in the controller for the desired result.
- Be careful programming the monitor card / key so as not to enable conflicting channels with compatibility.

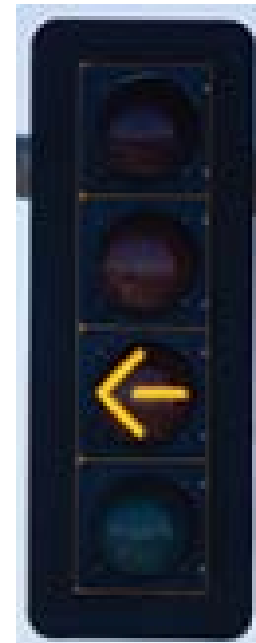
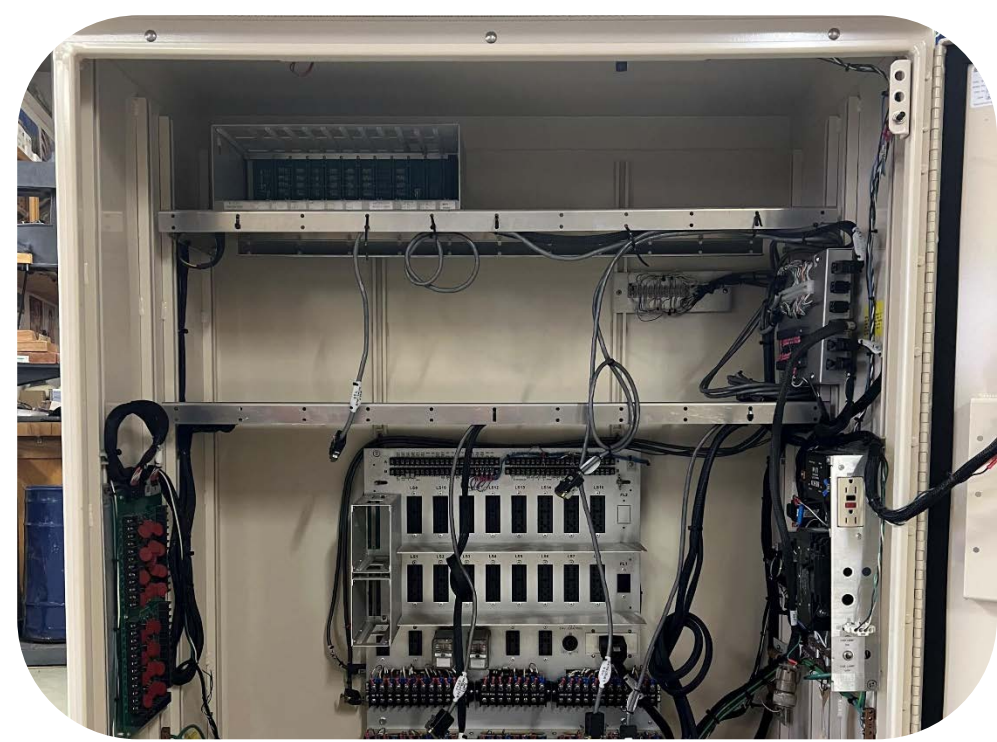

Cabinet Configuration

- *Configuration means to set up the cabinet for the specific intersection it will run*
 - Install flasher(s) in the flasher socket(s)
 - The flasher(s) provide the flashing output to the signals at a rate of 50 to 60 times per minute.
 - Install flash transfer relays (FTR's) in the appropriate sockets associated with the active vehicle and overlap channels.
 - Jumper FTR pins #5 to #7 and #6 to #8 for unused vehicle & overlap channels if monitored.
 - Do not plug in FTR's on the associated ped channels.
 - Check or configure the Red/Red or Red/Yellow flashing outputs to the field.
 - Most cabinets come from the factory set up for Red/Red flash (main street / side street)
 - Some agencies, however, may want the intersection to flash Yellow/Red (main street / side street)

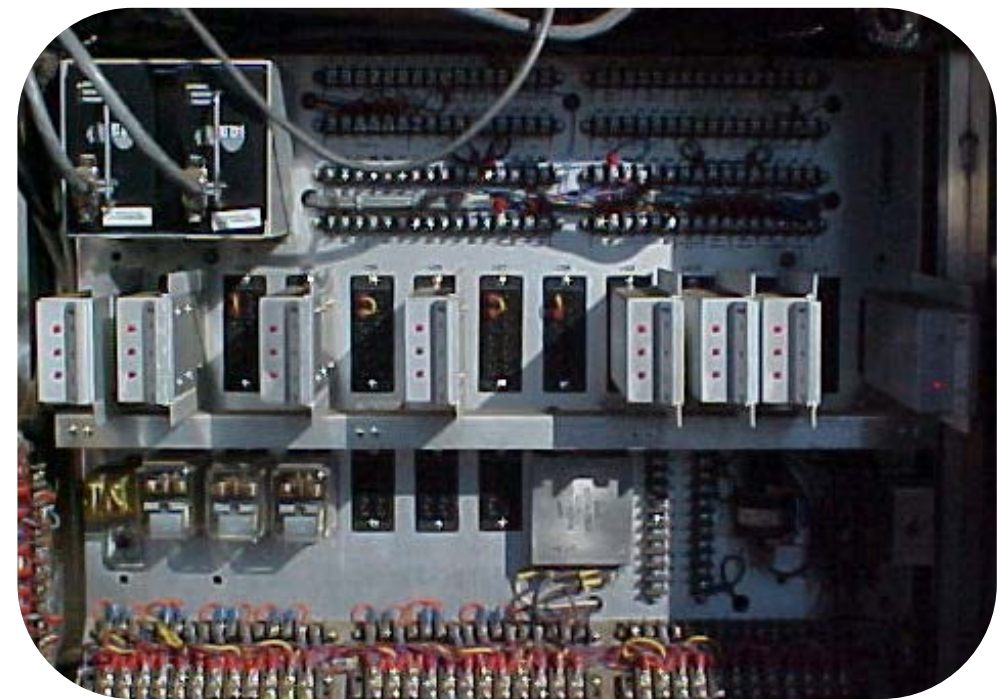
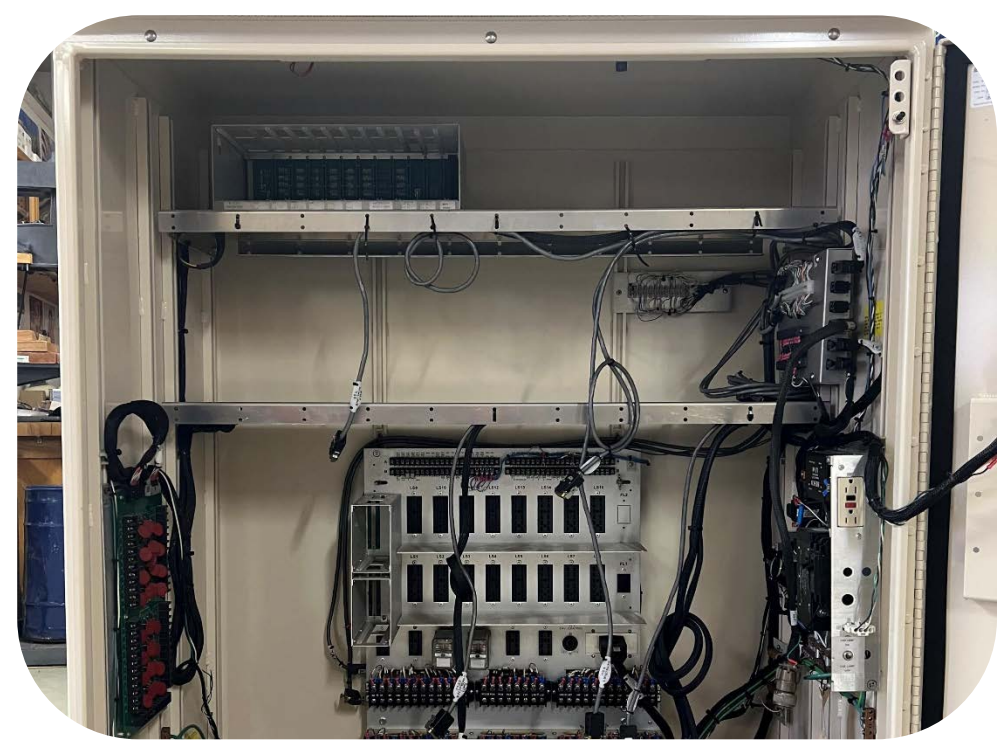

Cabinet Configuration

- *Configuration means to set up the cabinet for the specific intersection it will run*
- Plug in the appropriate BIU's in a TS2 cabinet or the appropriate SIU's in an ATC cabinet.
- BIU's / SIU's are the communications “switchboard” between the controller and the terminal facilities, MMU/CMU, the detector rack, and any optional / future equipment.
- Configure the detectors in the detector rack
 - 2 or 4 channel devices
 - Loops, magnetometers, video, infrared, microwave...
 - Some detection technologies may have their own standalone units that may need to be interfaced with the cabinet.
 - Preemption, if applicable will have to be configured.

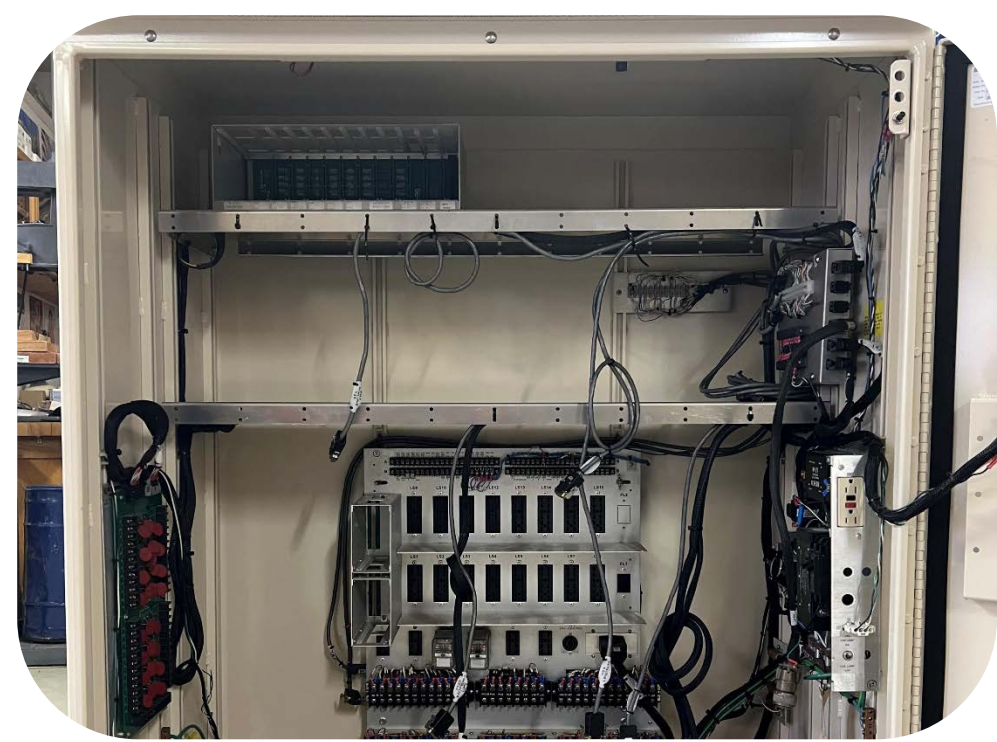

Cabinet Configuration

- *Configuration means to set up the cabinet for the specific intersection it will run*
 - Communications will need to be configured
 - Fiber optic patch panels
 - Ethernet switches & I.P. addresses
 - Modems
 - Interconnect
 - The MMU/CMU will have to be programmed:
 - Copper jumpers are soldered onto NEMA cards, remove diodes on type 170 cards, or program the monitor data key for channel compatibility and other settings & options.
 - Program NEMA MMU2 monitors and monitor keys for FYA, specific channel fault detection, and other features.
 - Channel compatibility in the MMU will be recorded in the controller and must match before the signal can be taken out of flash.

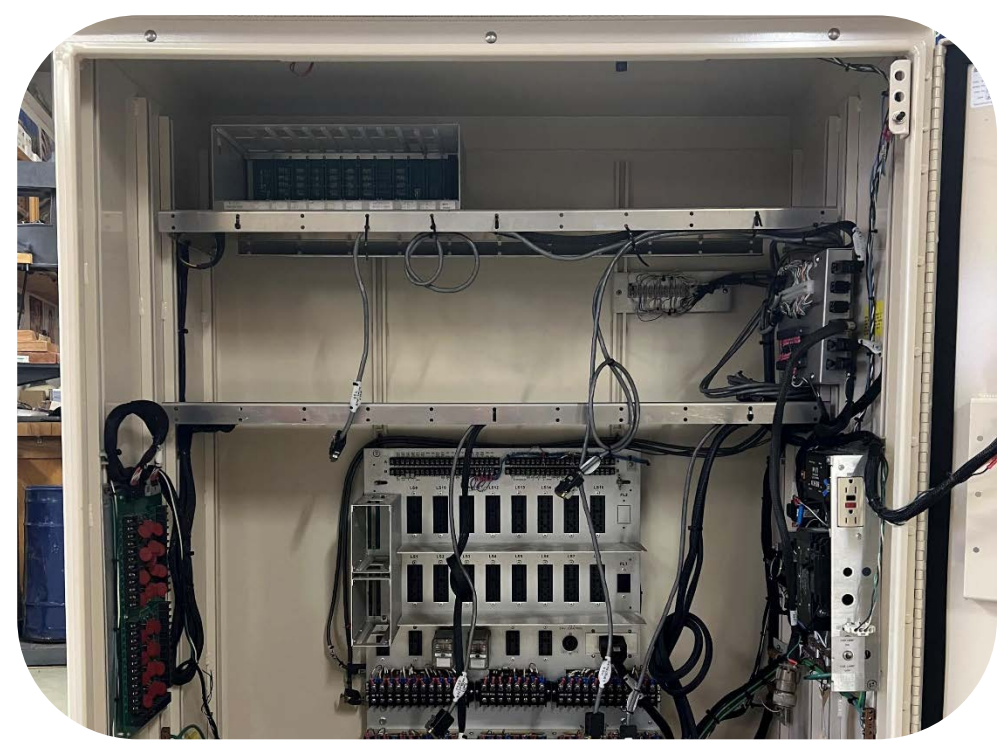

Cabinet Configuration

- Configuration means to set up the cabinet for the specific intersection it will run

So, what does it mean to program the MMU/CMU?

- That depends on the age of the monitor:
- At a minimum, you must establish channel compatibility by building the ring diagram on the card or in the data key.
 - The **TS-1, 12-channel conflict monitor** at the right would only need compatibility jumpers soldered on the program board.
- There are additional dip switches that can be enabled as the owner chooses to utilize additional functions such as:
 - Adjusting the minimum flash time, Dual selection, GY enable, WD enable, VM latch, CVM log disable, BND disable, and WALK disable
- Older monitors than this one may not have any additional features.

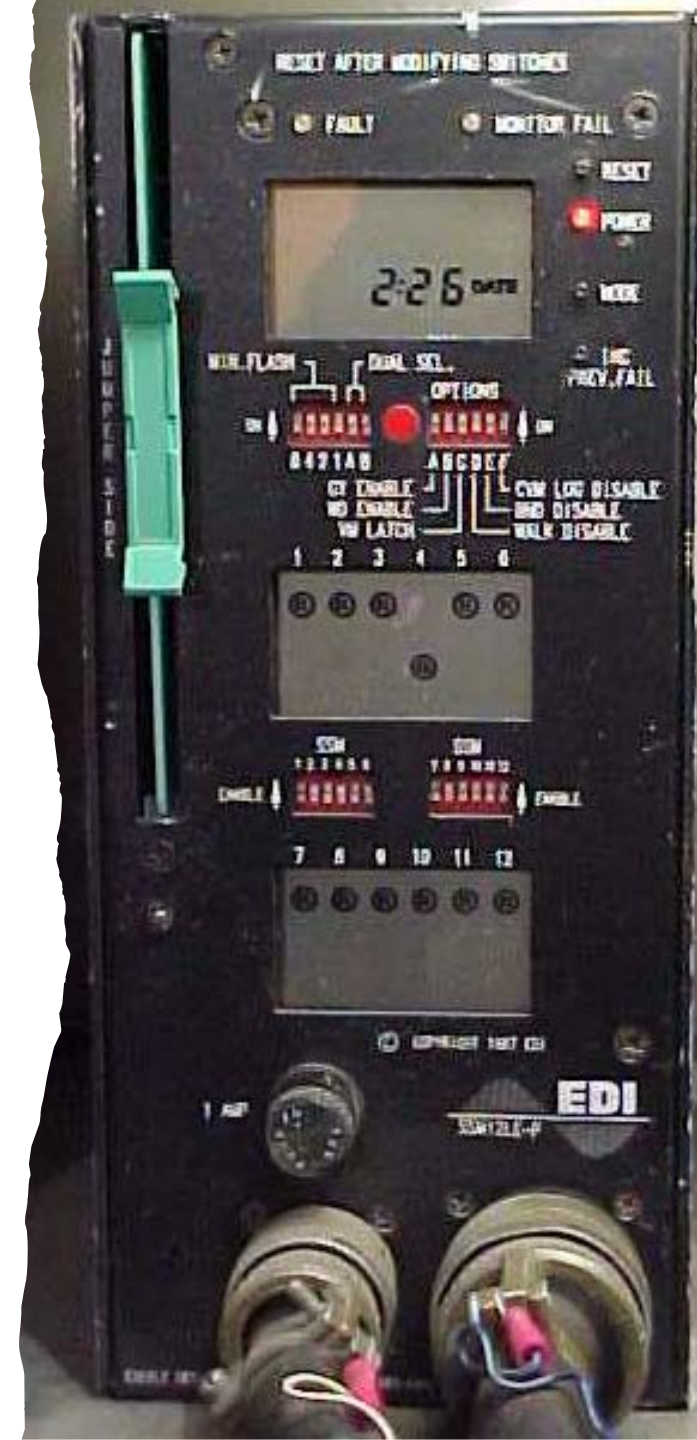
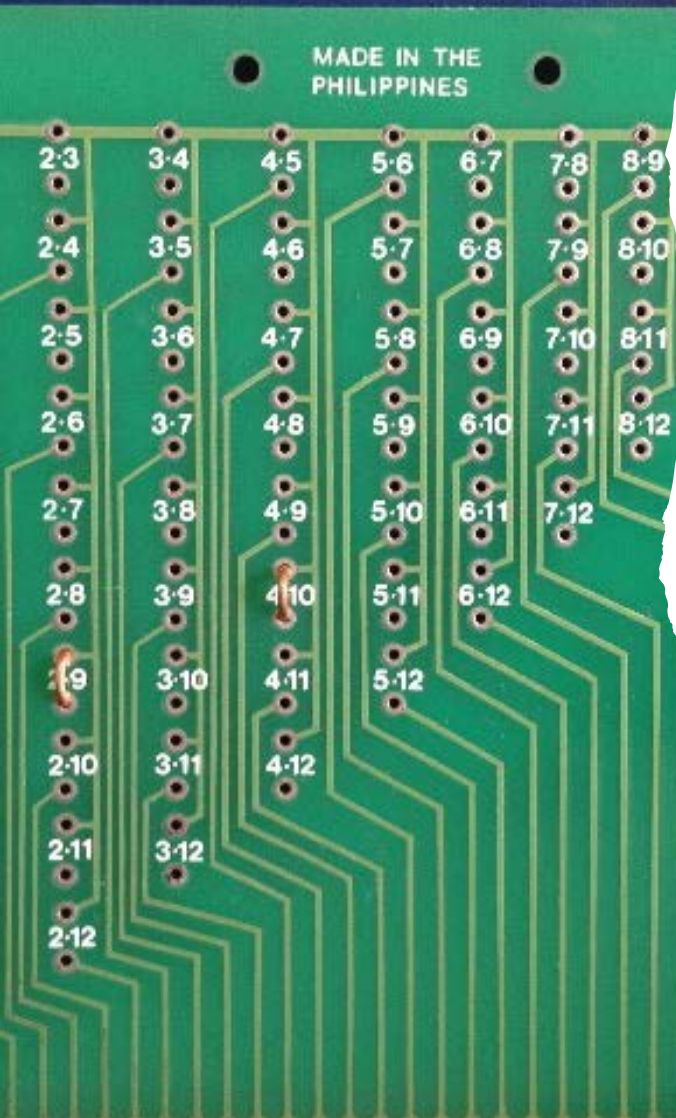

Cabinet Configuration

So, what does it mean to program the MMU/CMU?

- That depends on the age of the monitor:
- At a minimum, you must establish channel compatibility by building the ring diagram on the card or in the data key.
 - The **Type 170 conflict monitor, 16-channel conflict monitor** at the right would need compatibility diodes removed from the program board.
 - There are additional dip switches on the component PC board of the monitor that can be enabled for additional functions such as:
 - Adjusting the minimum flash time, Red fail per channel, GYR Dual indication per channel, GY-dual indication, Clearance fail, brown-out detection, LED sensing, RP detection...

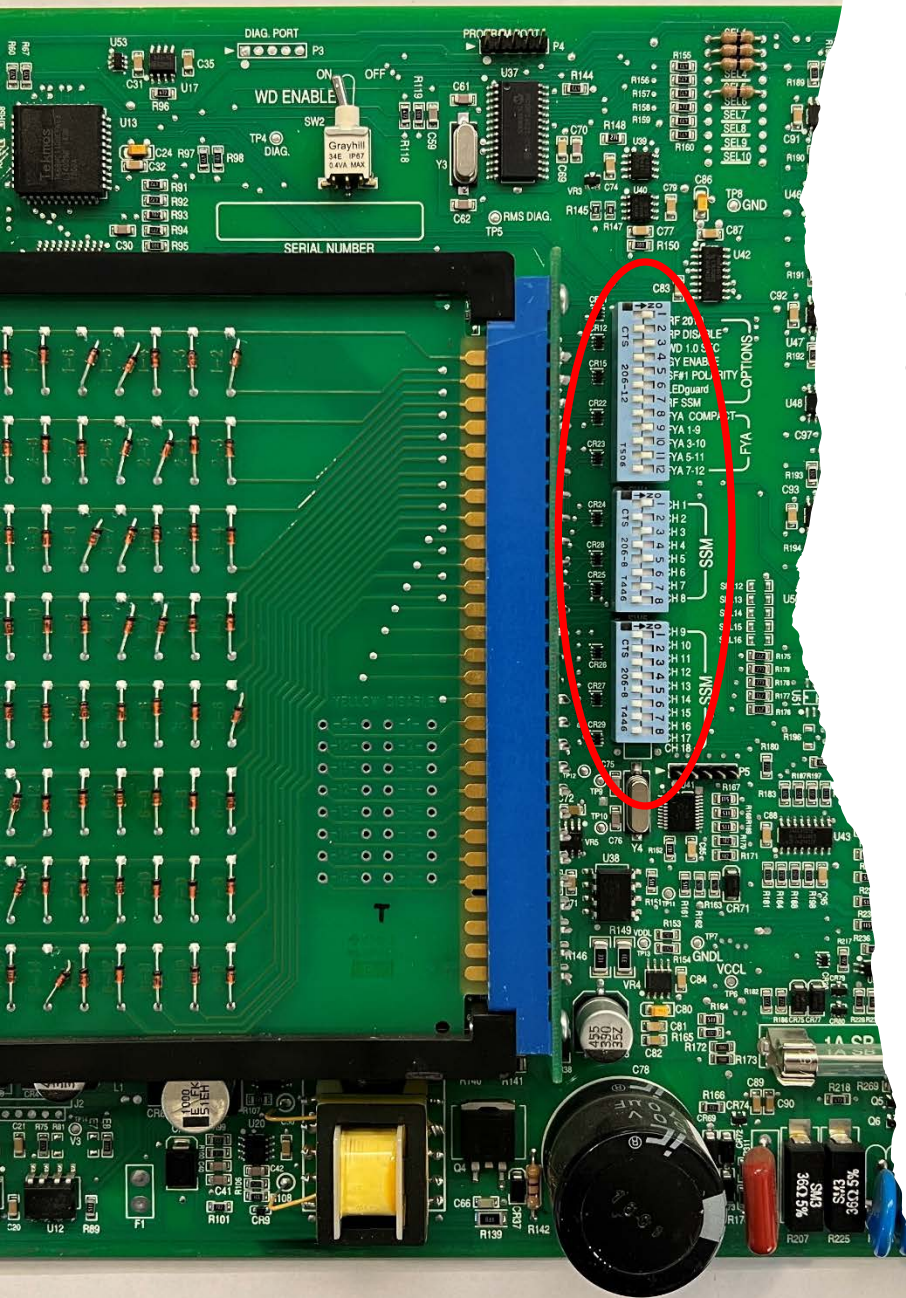

Cabinet Configuration

So, what does it mean to program the MMU/CMU?

- That depends on the age of the monitor:
 - Newer **TS-2, 16-channel MMU's** such as this one offers far more options
 - More available fault conditions
 - Additional features on the program board:
 - Minimum yellow change disable, minimum flash time, 24V latch enable, CVM latch enable
 - This too has additional dip switches that can be enabled as the owner chooses to utilize additional functions such as:
 - Field check / Dual selection per channel, GY enable, RP disable, WD enable, WALK disable, CF enable, CVM log disable.

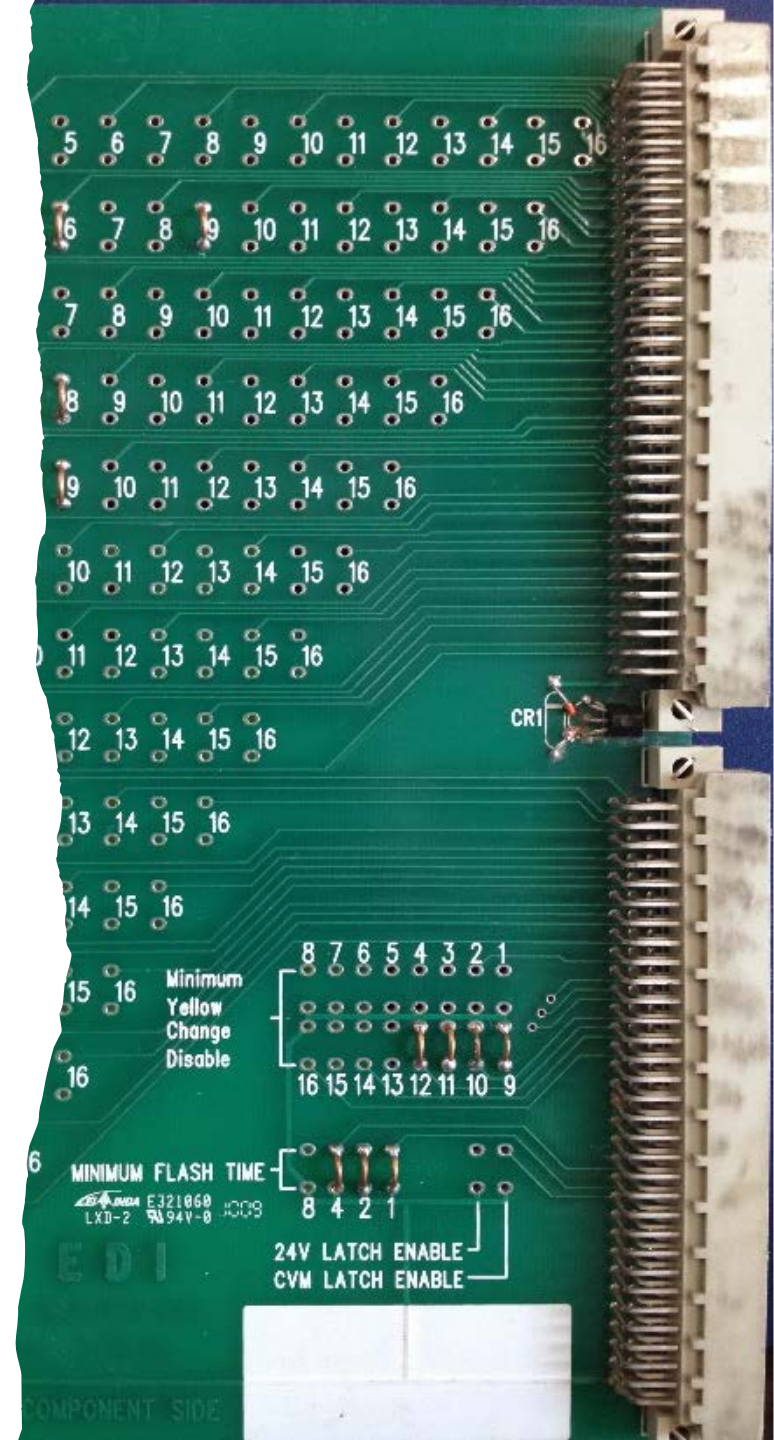



Cabinet Configuration

So, what does it mean to program the MMU/CMU?

- That depends on the age of the monitor:
 - The **ATC cabinet monitor** units changed to meet the additional capabilities of the cabinet.
 - Not only are optional dip switches gone, but so too is the program card.
 - **ALL the channel compatibility and additional features are now programmed in the monitors data key.**
 - The monitor houses the data key and displays the fault condition
 - The additional “Auxiliary Display Unit” (ADU) above displays 32 channels and an informational menu driven display screen.

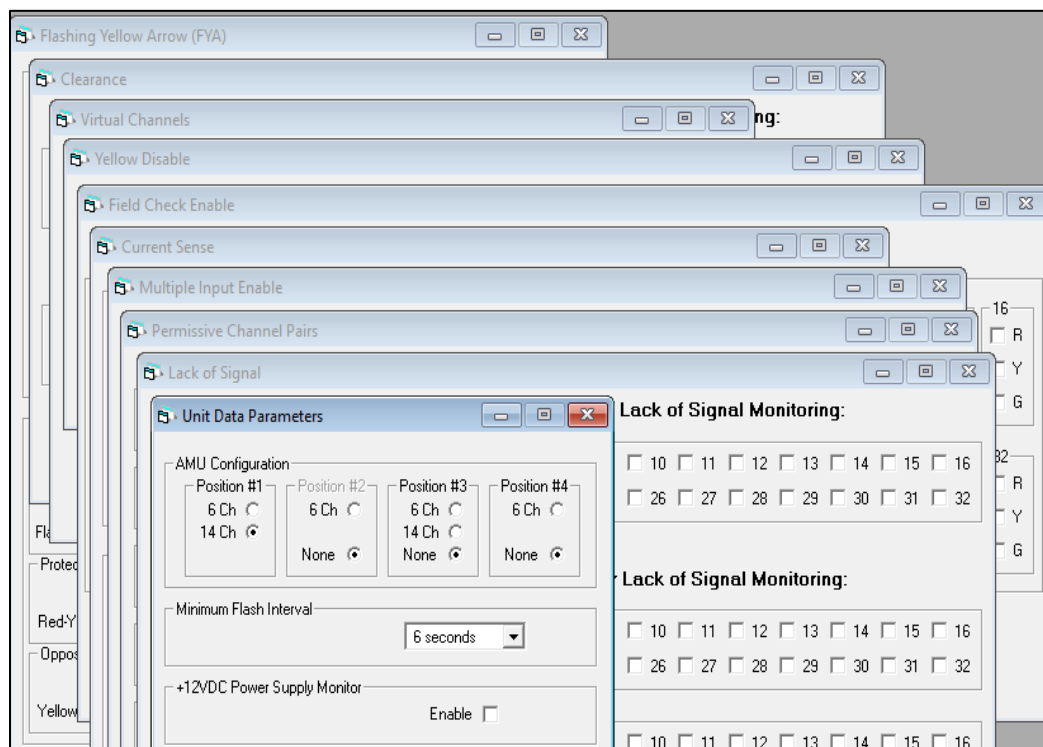

Software is necessary to program the monitor key

Cabinet Bench Testing

- Once the cabinet is configured, it is now time to “**bench test**”.
- **Bench testing** is letting the cabinet run as configured in a controlled environment.
- The cabinet is connected to a light board or a test box that replicates the actual intersection phases.
- Cabinets should be **bench tested for 24 to 72 hours**, depending on the agency's specifications, **without going into flash**.
- Once the cabinet passes the bench test, it may be installed in the field with confidence that it will run.
- Once installed, the field wiring must be verified and terminated to the proper output channels of the cabinet.

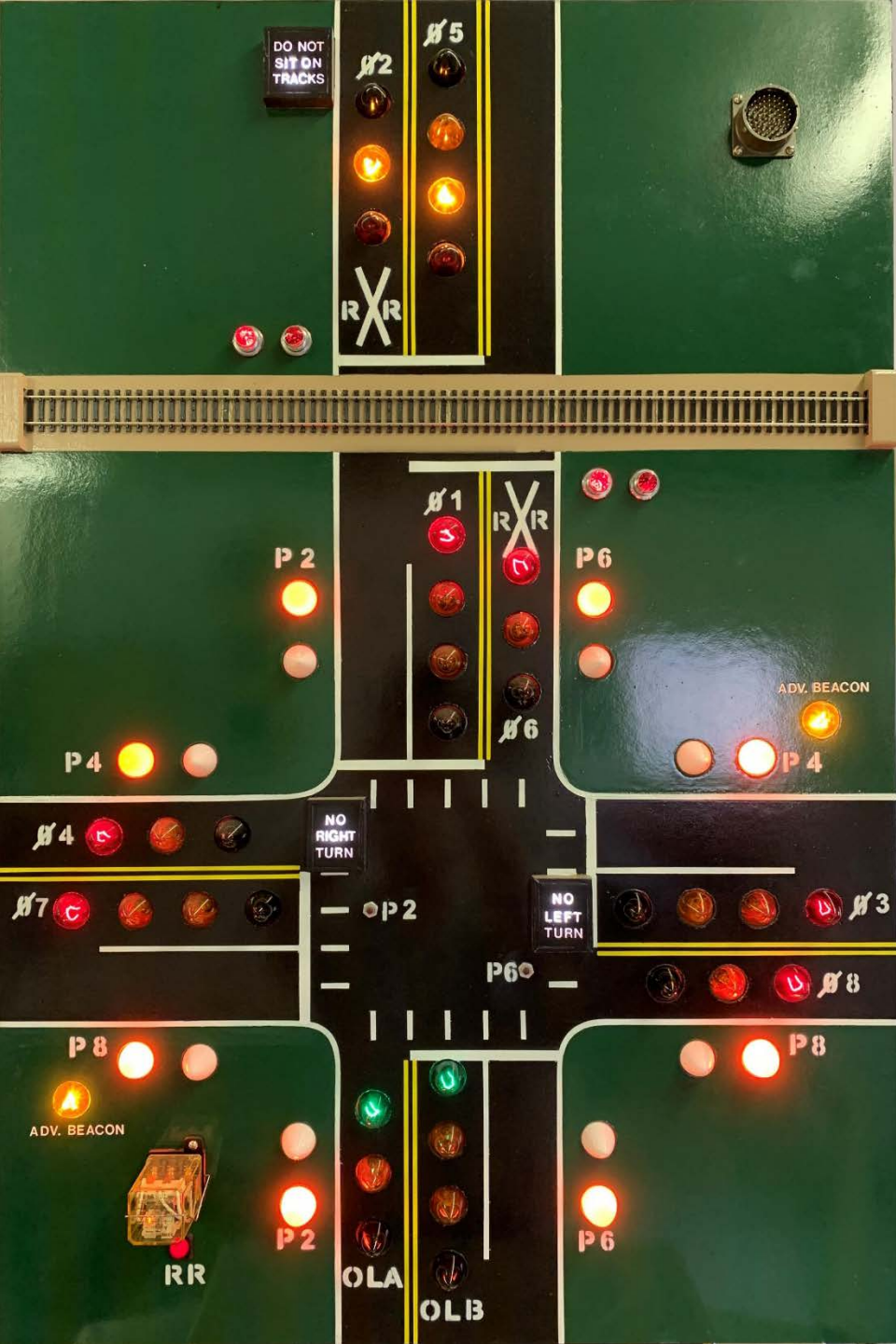

Knowledge Check: Fill in the Blanks

Identify the following pins:

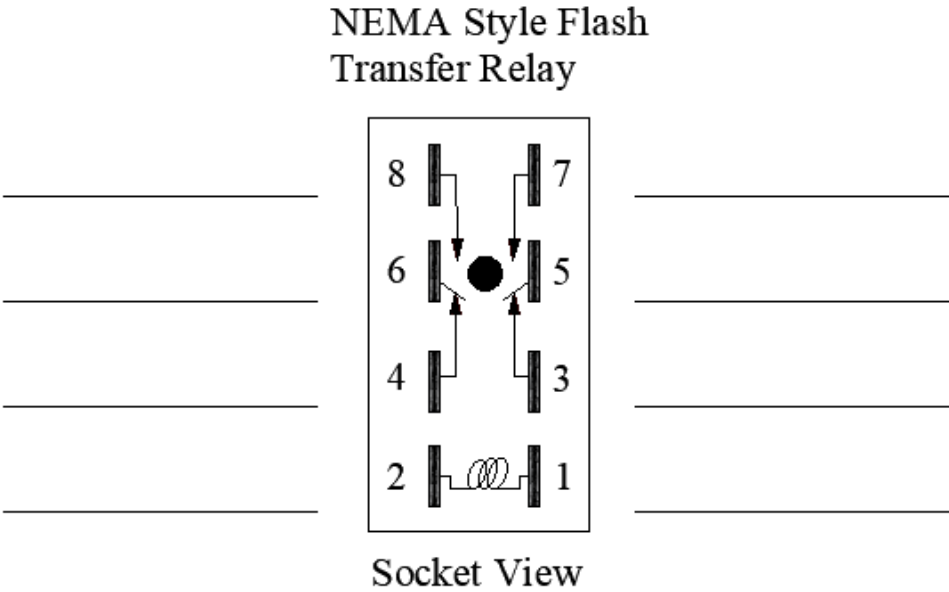
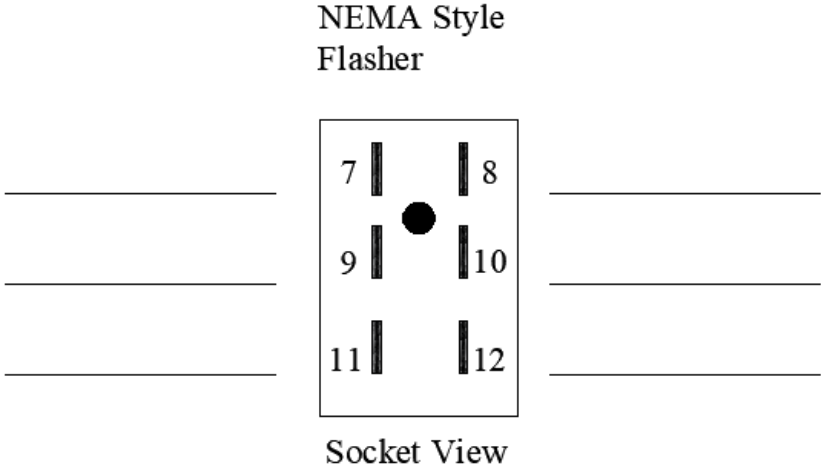
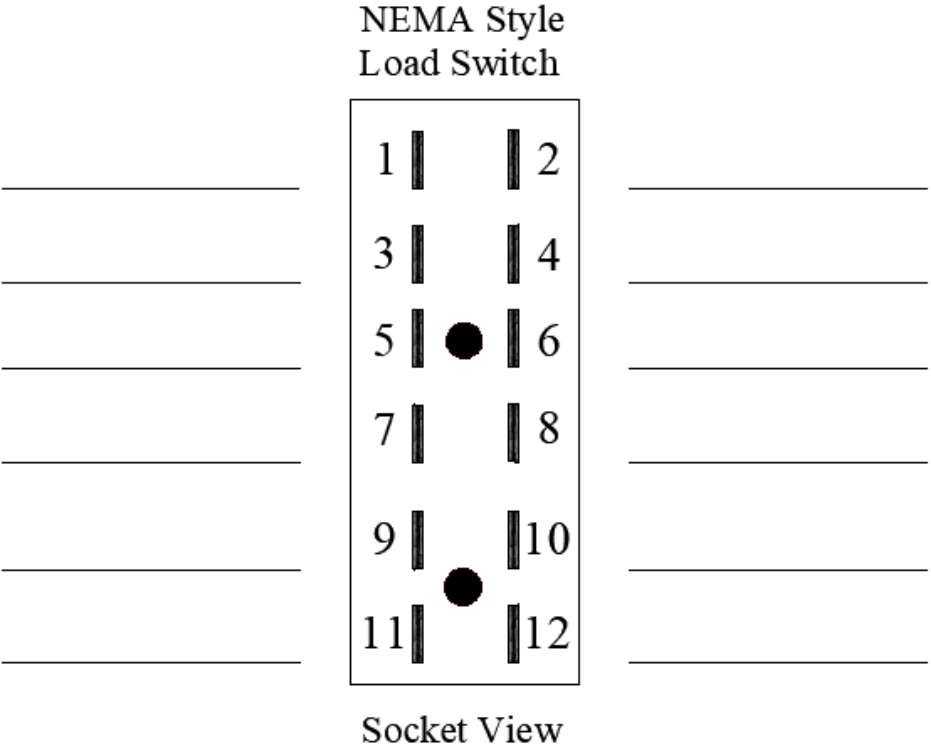

Knowledge Check: Fill in the Blanks

Identify the following pins:

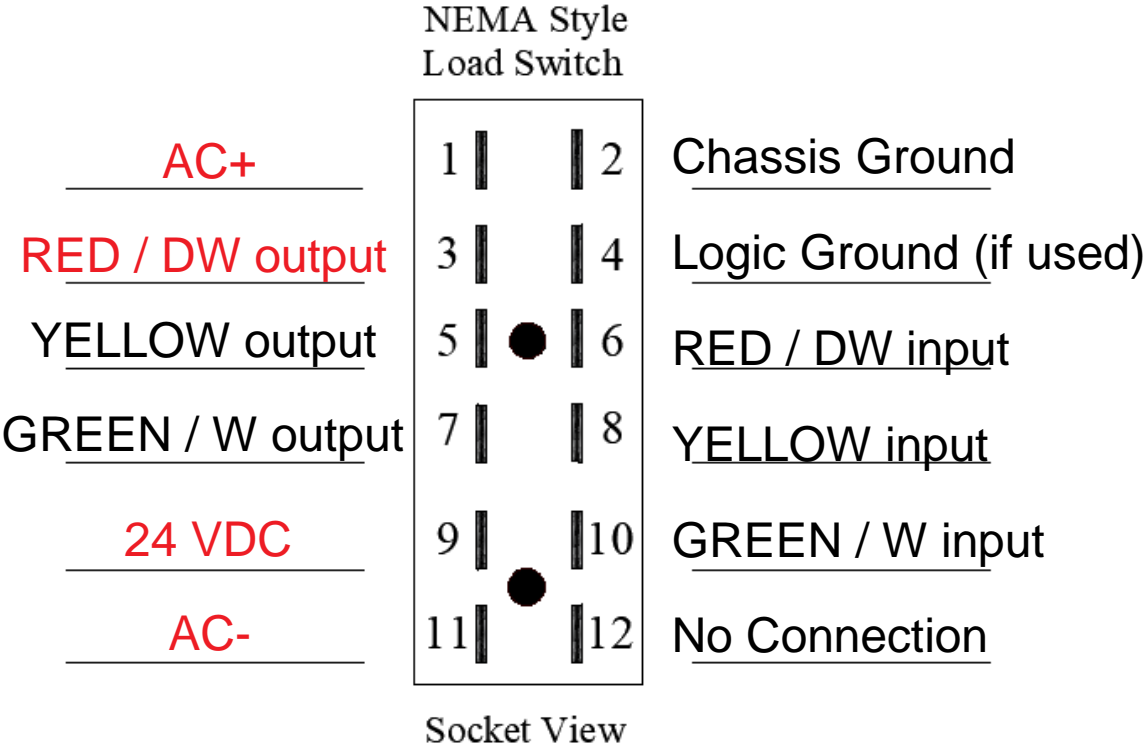

Knowledge Check: Fill in the Blanks

Identify the following pins:

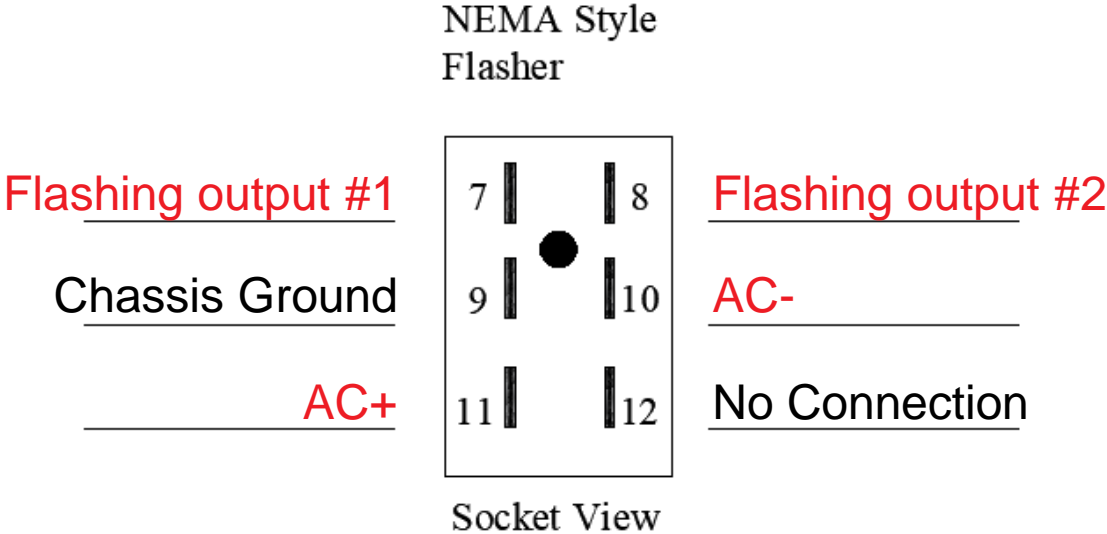

Knowledge Check: Fill in the Blanks

Identify the following pins:

NEMA Style Flash
Transfer Relay

Normally Open

Common

Normally Closed

AC+

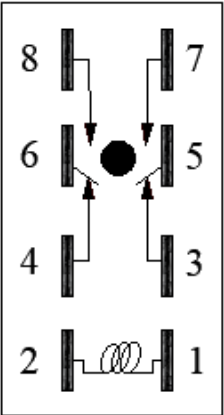

N.O.

Com.

N.C.

AC-

Socket View

Knowledge Check: Fill in the Blanks

Fill in the blanks with the correct words from the box below:

Mercury Contactor

Load Switch

SSR

Pin #11

Pin #1

Flasher

Flash Transfer Relay

1. The _____ feeds power to the _____ through _____.

The _____ has been replaced with the _____.

Knowledge Check: Multiple Choice

Where would you find a 242?

- a) The input file
- b) The output file
- c) The load switch bay
- d) The power panel

Knowledge Check: Multiple Choice

While troubleshooting a signal problem;
what information does the conflict monitor / MMU display?

- a) Who caused the problem.
- b) What problem occurred.
- c) When the problem occurred.
- d) How the problem occurred.

Knowledge Check: Multiple Choice

What information would a controller data base include?

- a) The phase timing, ring sequence, cabinet voltage, & coordination plans.
- b) The phase timing, coordination plans, cabinet I/O, & 24 VDC monitoring.
- c) The ring sequence, phase timing, overlaps, & the CVM output.
- d) The ring sequence, phase timing, coordination plans & preemption control.

Knowledge Check: Multiple Choice

How do you handle an unused phase in a cabinet with respect to the load switch?

- a) Jumper pins #1 to #3
- b) Jumper pins #1 to #7
- c) Jumper pins #5 to #7
- d) Nothing special needs to be done.

Knowledge Check: Multiple Choice

What type of monitor must be used to program a flashing yellow arrow in a NEMA cabinet?

- a) A conflict monitor
- b) A model 210 monitor
- c) A TS-2 MMU2 monitor
- d) An auxiliary display unit

IMSA Traffic Signal Field Technician II

Session 4: Controllers - Intervals, Timing,
Cycle Length and Coordination



Advancing the Future of Public Safety

Traffic Signal Operation Review

- **Pre-timed Operation:** Pre-timed operation provides a predetermined cycle length, regardless of flow of traffic or pedestrians. These may be found in a downtown business district or a campus environment. There is seldom a need for vehicle or pedestrian detection at these signals.
- **Semi-Actuated Operation:** In semi-actuated operation, detection is provided to the phases controlling the minor street movements and the left turn movements. The cycle length is variable and based on the flow of traffic & pedestrians. This operation is most often found in metropolitan areas with one or two major crossing arterials.



Traffic Signal Operation Review

- **Fully-Actuated Operation:** In fully-actuated operation, detection is provided to all the phases at an intersection. This type of operation is often used at rural intersections. The cycle length is solely dependent on the flow of traffic and therefore has no set amount of time.

- **Coordinated Operation:** Traffic signals that are coordinated, operate with a defined cycle length chosen by the time-of-day. The chosen cycle length is based on traffic studies that provide the expected flow of traffic and pedestrians. Coordinated signals usually operate in either a pre-timed or semi-actuated mode.



Controller Timing Intervals

A “**phase**” is described as a group of timing intervals and settings that reside within the controller for the purpose of controlling a specific movement of traffic.

The list of **Controller Timing Intervals** may vary between manufacturers, however, there are a basic list of intervals that all manufacturers use. We will concentrate on those intervals with example times shown:

Minimum Green – 7 sec.

Bike Green – 15 sec.

Passage – 5 sec.

Max I, II, or III – 25, 35, 50 sec.

Yellow Clearance – 3 sec.

Red Clearance – 2 sec.

Red Revert – 2 sec. (not shown)

Walk – 7 sec.

Don't Walk – 15 sec.

of actuations B4 – 6 vehicles

Added Initial – 1.8 sec. / car

Max Initial – 24 sec.

Cars Wait B4 – 10 cars

Time Before Reduction (TBR) – 8 sec.

Time to Reduce (TTR) – 10 sec.

Minimum Gap – 1.6 sec.

Controller Timing Intervals

Minimum Green or Initial– Minimum green is the guaranteed amount of time for a particular phase and cannot be forced off. Its purpose is to get the queue of vehicles moving into the intersection once the phase turns green.

Bike Minimum Green– This interval allows the controller to time a longer minimum green interval based on a detection input from a bike lane, thus allowing more time for a slower vehicle to enter the intersection. The controller times this interval instead of the minimum green interval one time for the upcoming service of that phase.

Passage Time– This is the amount of time added to the green interval based on each vehicle actuation. The passage timer begins timing only when the detection area is cleared and begins counting down from the programmed time to zero. Once the passage timer reaches zero, the phase can terminate due to *"gap out."*

The term **"Gap"** represents the distance between vehicles. The passage interval can be programmed to time sequentially after the minimum green interval or concurrently with the minimum green interval.

Controller Timing Intervals

Here's what Min green, Bike green and concurrent timing Passage looks like.

- Every time a vehicle is detected during the passage interval, the passage timer resets and begins counting down again.

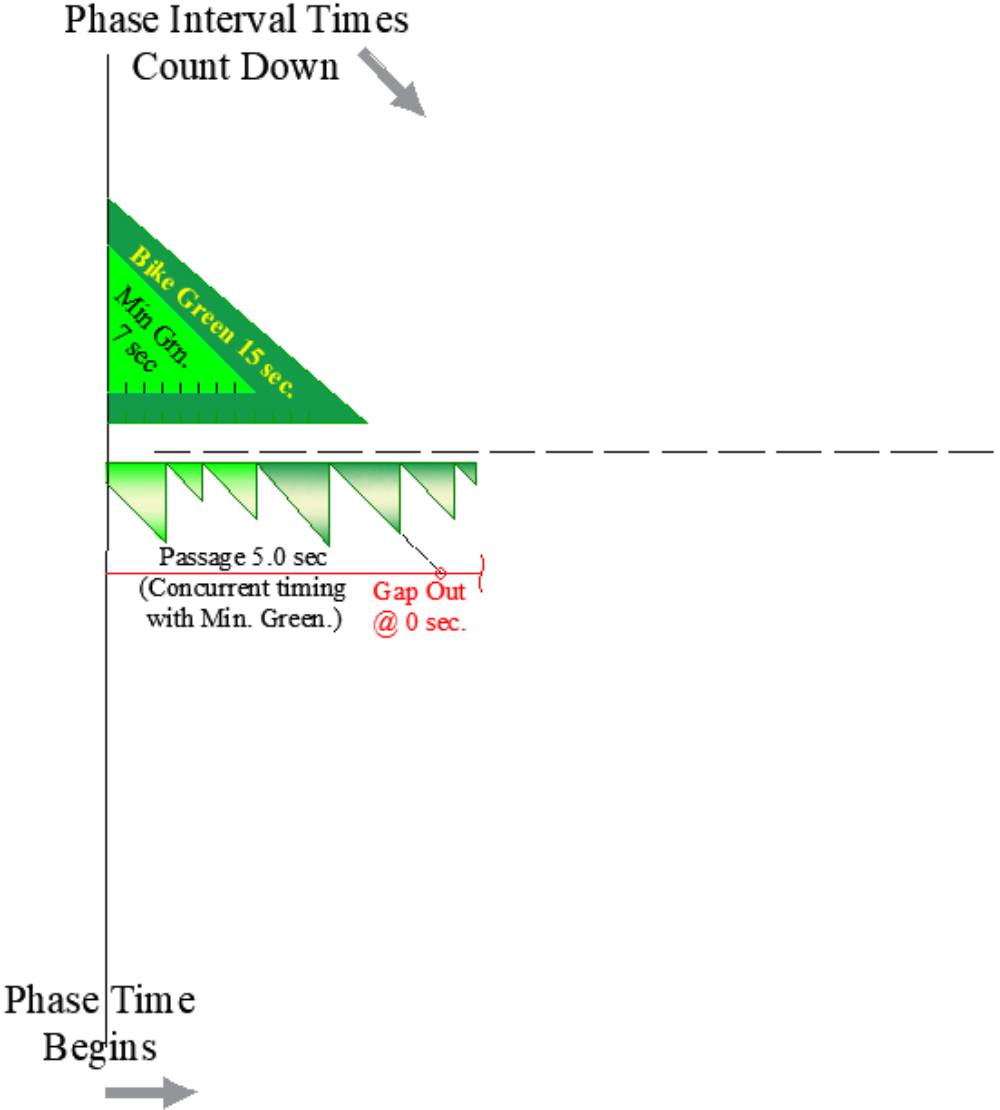

Controller Timing Intervals

Maximum I, II, or III– The maximum (Max) interval is the maximum amount of time a phase will be in a green condition, once the max timer begins counting down. *The max timer only begins timing once a conflicting phase has a serviceable call.* The phase will terminate once the max timer reaches zero (*max out*). Only one max interval may be in effect at any given time.

Yellow– The yellow clearance interval follows the terminated green indicating the right-of-way is about to change. Yellow clearance will never be less than 3.0 seconds per the FHWA, and it cannot be shortened.

Red Clearance / All Red– The red clearance interval allows vehicles additional time to clear the intersection before conflicting cross-traffic is released. Red clearance is an optional interval, but if used, it cannot be forced off.

Red Revert– This is a special interval that forces the controller to time a red interval before returning to a green indication due to a preemption call. It prevents a green-yellow-green sequence being seen by any motorists.

Controller Timing Intervals

Here's what the serviceable call on an opposing phase, the Max I, II, III, Yellow, & Red looks like.

Note: the serviceable opposing call may be present anywhere along the horizontal line during any given cycle.

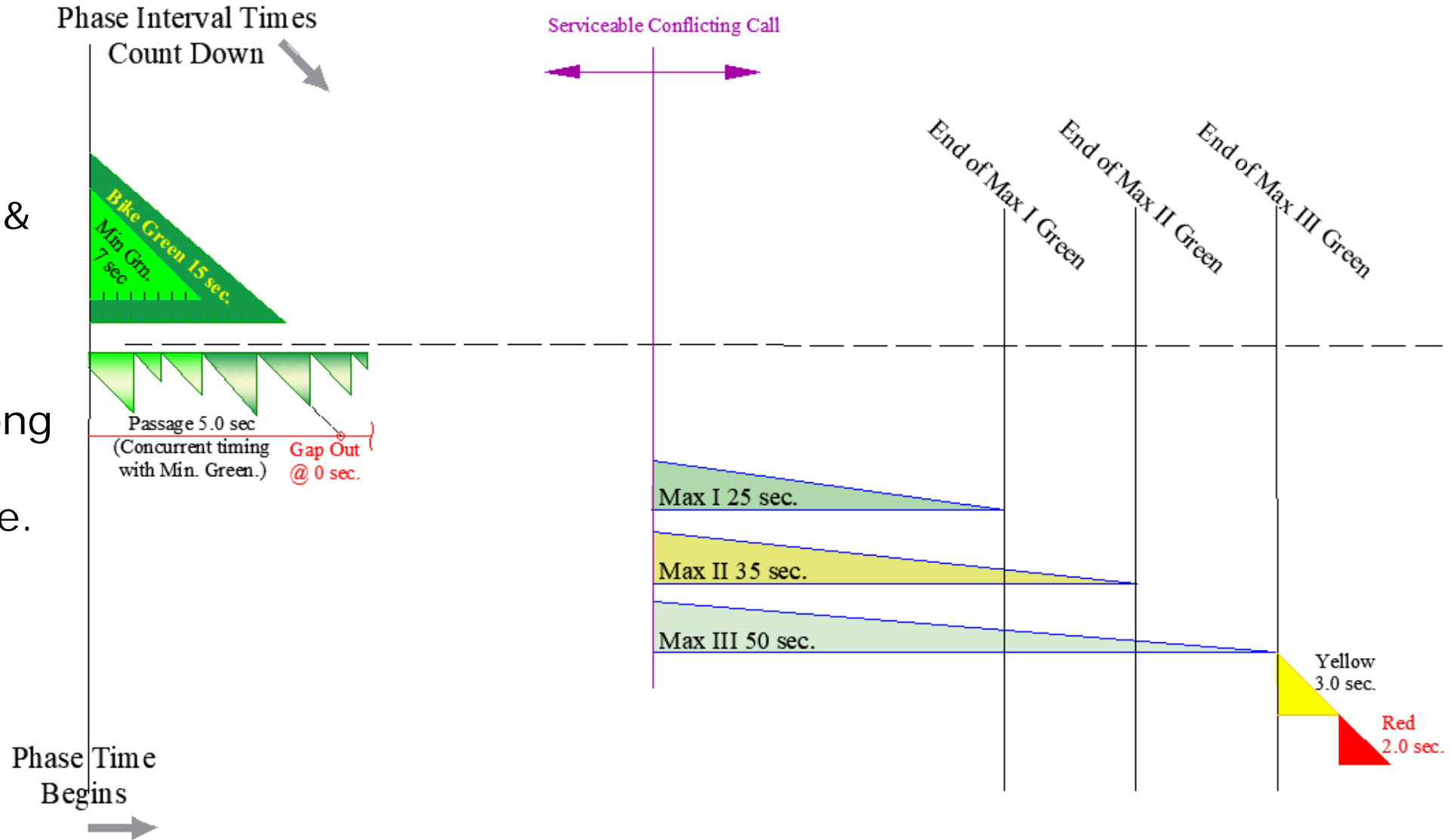

Controller Timing Intervals

Walk – This is the amount of time given for a walk signal to allow a pedestrian to begin crossing the street.

Pedestrian Clearance / Flashing Don't Walk – The pedestrian clearance interval is the amount of time allowed for the pedestrian to safely cross the intersection. It is calculated by dividing the distance across the crosswalk by an average walking speed of 3.5 feet per second. This interval provides enough time for a pedestrian to completely cross the intersection if they enter the crosswalk at the very end of the walk interval. This clearance interval can be shortened under special circumstances.

Volume Density Functions – Volume density offers two advantages under specific circumstances.

- 1. Variable Initial Timing** – Allows for a longer minimum green interval based on vehicle actuations during the yellow and red portions of a phase. The controller will time the extended minimum green the next time it services that phase.
- 2. Gap Reduction** – This function allows the gap to be reduced during the green portion of a phase so that the phase may reach gap out sooner.

Controller Timing Intervals

Now we add the Walk, Flashing Don't Walk, & the Solid Don't Walk intervals.

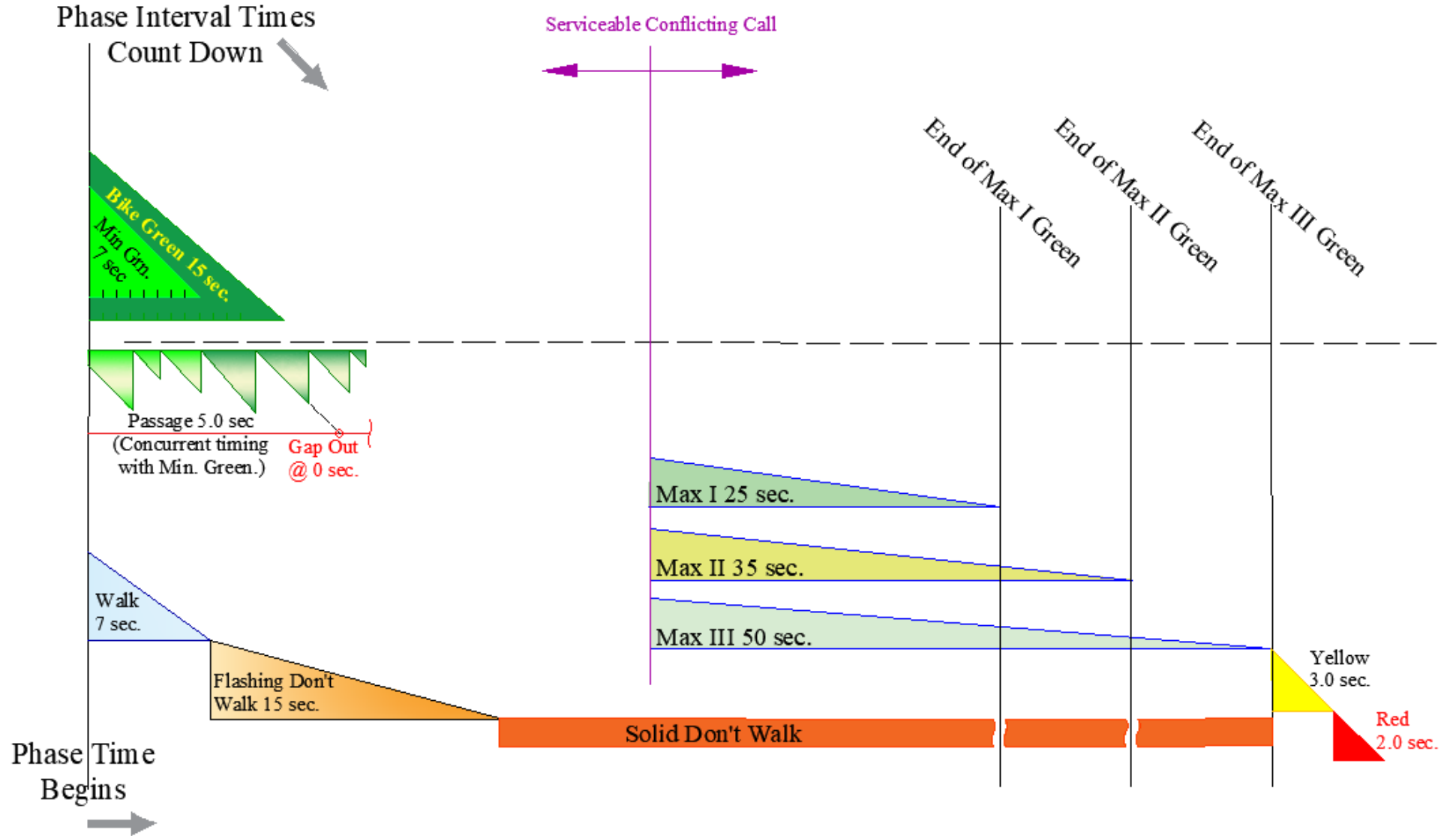

Controller Timing Intervals

Volume Density Functions – Volume density offers two advantages under specific circumstances.

Variable Initial Timing – Allows for a longer minimum green interval based on vehicle actuations during the yellow and red portions of a phase. The controller will time the variable initial interval concurrently with the minimum green interval the next time it services that phase. Variable initial timing uses three intervals:

- 1. # of actuations B4**– This is an optional counter that may establish a minimum number of vehicles before any variable initial timing takes place.
- 2. Added Initial / Seconds Per Actuation**– This is the amount of time added to the variable initial interval for each vehicle actuation.
- 3. Max Green or Max Initial**– This is the maximum amount of time that can be added to the variable initial interval.

Controller Timing Intervals

Now we add the # of Actuations B4, Added Initial and the Max Initial intervals.

Also added is the portion of the passage interval that times sequentially.

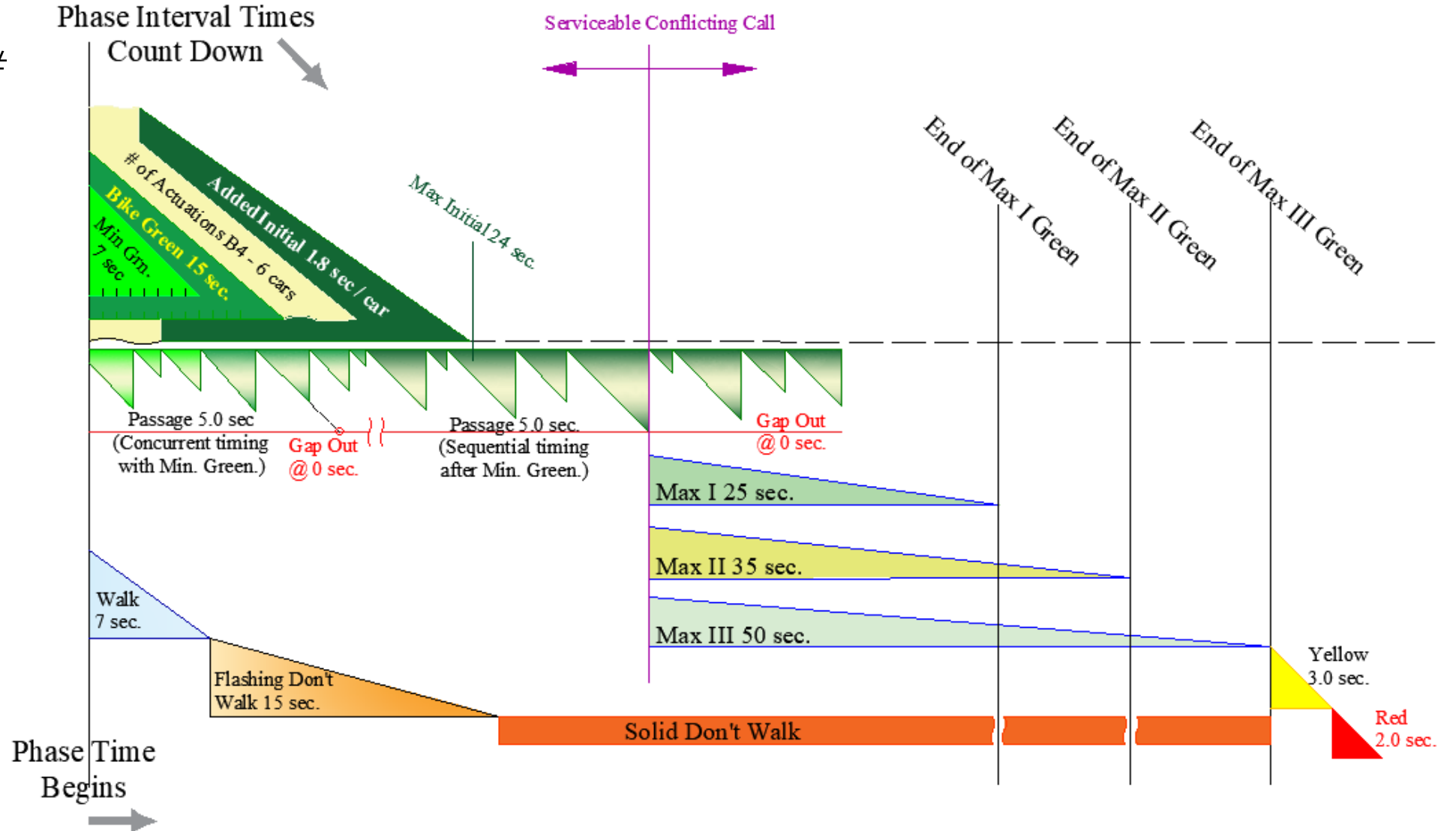

Controller Timing Intervals

Volume Density Functions – Volume density offers two advantages under specific circumstances.

Gap Reduction – This function allows the gap to be reduced during the green portion of a phase so that the phase may reach gap out sooner. Gap reduction only begins with a serviceable call on a conflicting phase. Gap reduction uses four intervals:

- 1. Cars Waiting B4** – An optional counter that sets a minimum number of vehicles before gap reduction takes place. It is based on the flow rate of traffic on conflicting phases during the green portion of the phase.
- 2. Time Before Reduction (TBR)** - This is the delay time before gap reduction occurs. If the serviceable opposing call disappears during this interval, gap reduction does not take place.
- 3. Time To Reduce (TTR)** – Once the TBR timer reaches zero, TTR begins. The physical gap between vehicles is being reduced in time during this interval so that the phase may reach *“gap out”* sooner.
- 4. Minimum Gap** – This becomes the minimum amount of passage time once the TTR interval has terminated.

Controller Timing Intervals

Lastly, we add the Cars wait B4, TBR, TTR, & the Min. Gap.

Notice the gap reduces during the TTR interval to the minimum gap time.

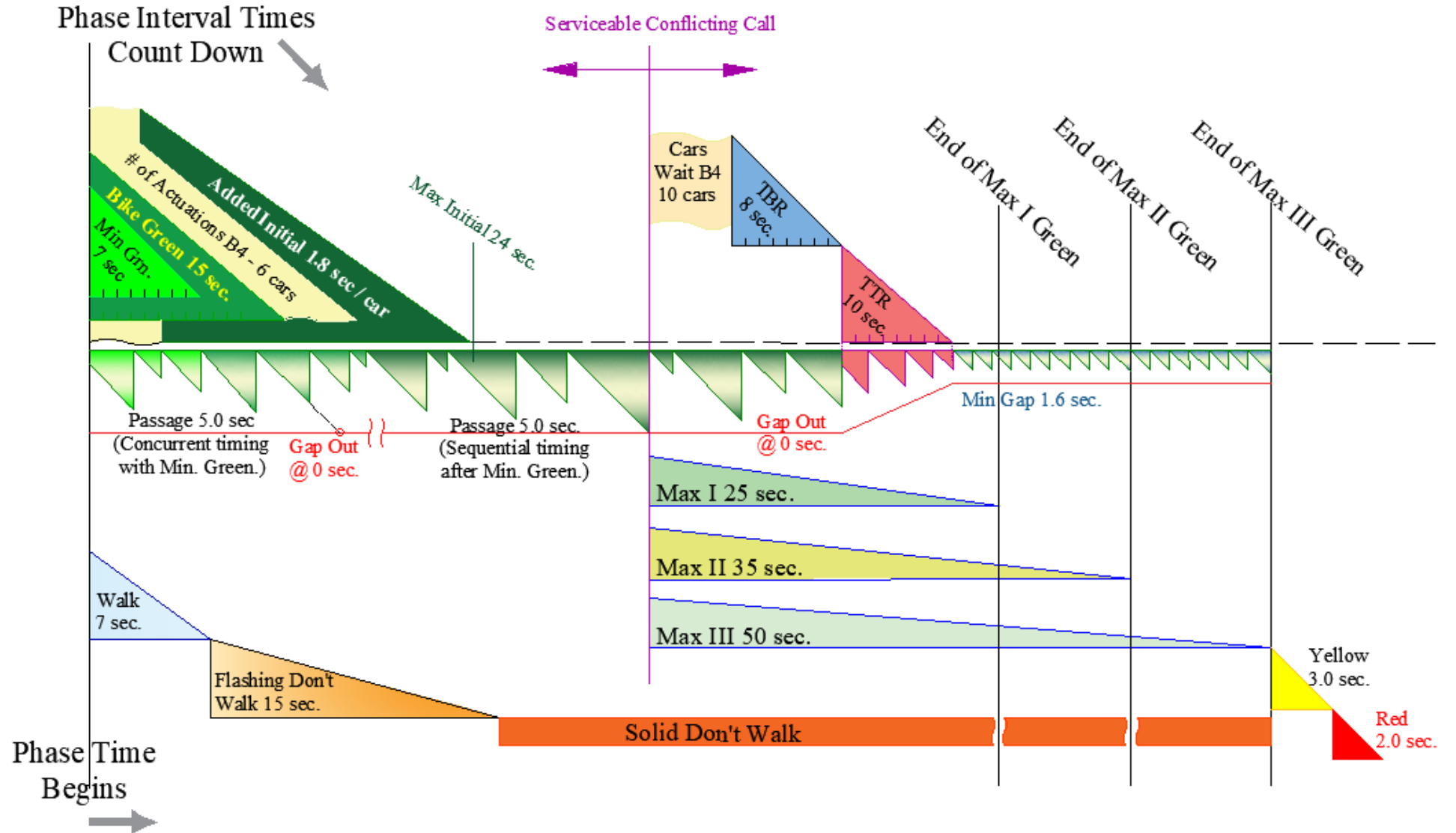

Cycle Length

Cycle Length: A cycle length is defined as *“the total amount of time for a complete sequence of signal indications.”*

- It represents the duration of time for the signal to go through all its programmed phase(s) and intervals for all movements of traffic per the ring diagram as well as the operational mode chosen at the intersection.
 - ***Pre-timed operation*** – The signal runs a predetermined cycle length regardless of vehicle and pedestrian flow.
 - ***Semi-actuated operation*** – The cycle length is variable due to the flow of traffic on the actuated phases; side streets & left turns. Passage intervals can extend the green time; however, the controller will always return to service the non-actuated phase(s).
 - ***Fully-actuated operation*** – This operation has no predictable cycle length. All phases have vehicle & pedestrian detection, which means the controller services phases as required. Passage intervals extend the green time, however the controller will only cycle to the next phase(s) with a demand for service.

Cycle Failure

A **Cycle Failure** occurs when the demand exceeds the capacity of the intersection, resulting in vehicles unable to clear the intersection within one cycle. **Issues that may cause a cycle failure:**

- Unusual traffic volume's
- Improper controller timing
- Inadequate split timing in a coordination plan
- Improperly placed force offs in a coordination plan
- Time-of-day programming
- Defective detection over several cycles
- Improperly set clock

Resolving a cycle failure in a traffic signal may include:

- Reviewing and / or reprogramming the controller
- Setting the clock
- Verifying the detection hardware for proper operation
- Verify the operating voltages from the power supply



Traffic Signal Coordination

Advantages of Traffic Signal Coordination:

- **Efficient Traffic Flow:** Properly coordinated traffic signals allow for a smoother flow of traffic, minimizing stops and delays.
- **Fuel Efficiency and Emission Reduction:** By reducing unnecessary stops and idle time at intersections, traffic signal coordination can result in more fuel-efficient vehicle operation and less emission of pollutants.
- **Safety Improvement:** Coordinated traffic signals can contribute to a safer roadway environment by reducing erratic driving behaviors like unnecessary braking and acceleration, which can lead to accidents.
- **Maximize Capacity:** Coordinated signals help to utilize the full capacity of the roadway, helping to handle more vehicles efficiently.



Traffic Signal Coordination

Disadvantages of Traffic Signal Coordination:

- **Difficulty in Balancing Multiple Traffic Directions:** It can be challenging to balance the needs of traffic moving in multiple directions. Prioritizing one direction can lead to increased delay for other directions.
- **Increased Delay for Pedestrians:** Coordinated signals often prioritize vehicular traffic, which can result in longer wait times for pedestrians trying to cross intersections.
- **Complexity and Cost:** Designing, implementing, and maintaining a coordinated traffic signal system can be complex and costly, requiring traffic engineering expertise and regular adjustments to keep up with changing traffic patterns.
- **Inefficiency During Off-Peak Hours:** While coordination is beneficial during peak traffic periods, it can lead to unnecessary waiting times at intersections during off-peak hours when traffic volumes are lower.



Traffic Signal Coordination

Coordination – *Coordination is defined as the process by which two or more traffic signals are synchronized so that platoons of traffic can maintain progression through the system without stopping.*

In order to achieve coordination, you must understand several terms that are used:

- **Background Cycle** – An artificial cycle length (shown in red) imposed on the controller based on the expected traffic flows throughout various times of the day or night. Various background cycles may be used for the AM peak hour, PM peak hour, and any other time of day, if so desired by the agency owner.
 - A background cycle is nothing more than a clock dial, which begins timing at the top center and counts “up” in time in a clockwise direction.

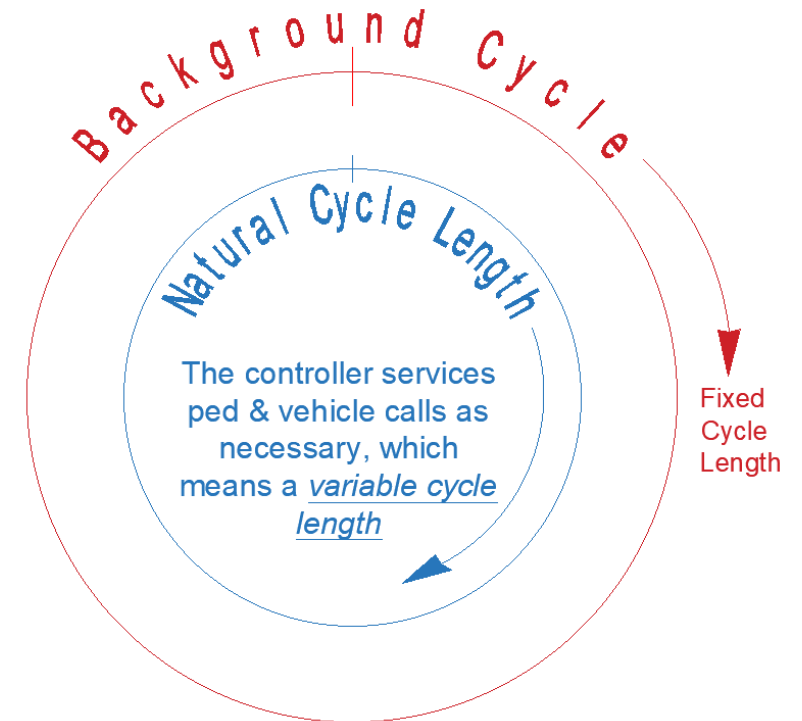

Traffic Signal Coordination

In order to achieve coordination, you must understand several terms that are used:

- **Split** - A "split", as defined by NEMA refers to 'the segment of the cycle length allocated to each phase that MAY occur' (expressed in percentage or seconds).
 - It *includes* the Green, Yellow and Red intervals.
 - In an actuated controller – the split is the time in the cycle allocated to a phase. All phase times must fit within the given split time.
 - In a pretimed controller – split is the time allocated to an interval.
- **Force off** – A force off is a priority input that is used to terminate the active green, thereby determining the amount of green time for any given phase within the background cycle. The clearance interval times are placed in the background cycle from the timing sheet.

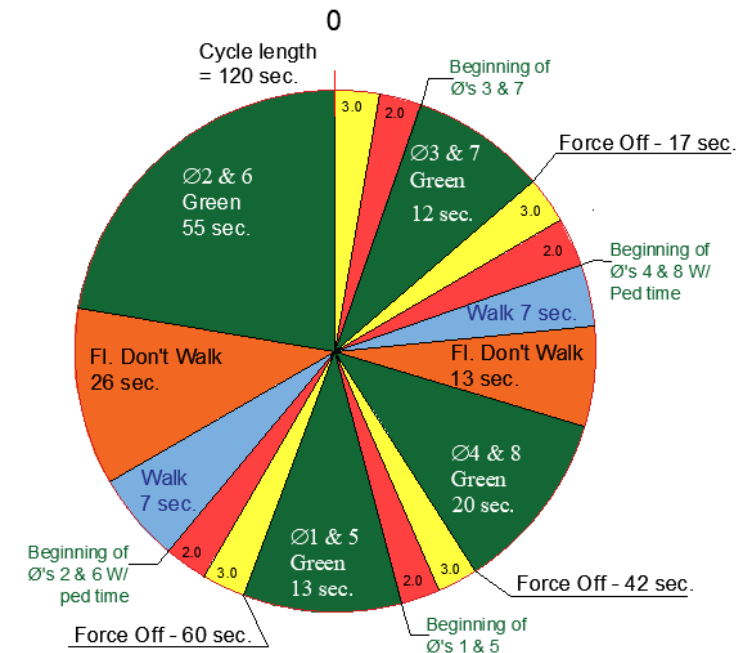
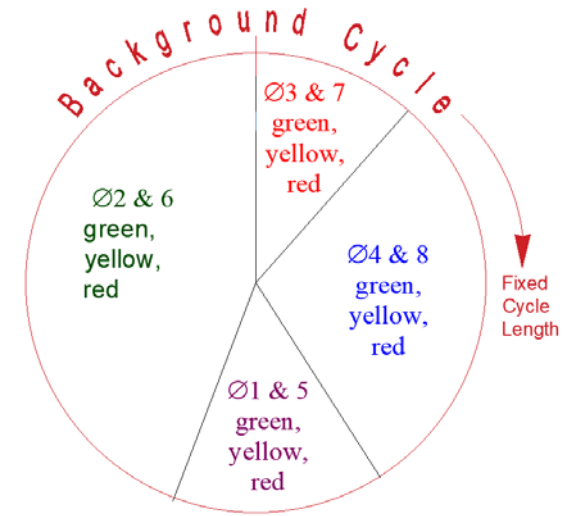

Traffic Signal Coordination

In order to achieve coordination, you must understand several terms that are used:

- **Hold** – A hold in another priority input that retains the existing green interval.
 - A hold is applied at the beginning of the coordinated green to ensure the controller remains in that phase(s).

- **Yield Point** – A command which permits termination of the green interval.
 - The hold is dropped at the yield point thus allowing the controller to service any opposing calls.

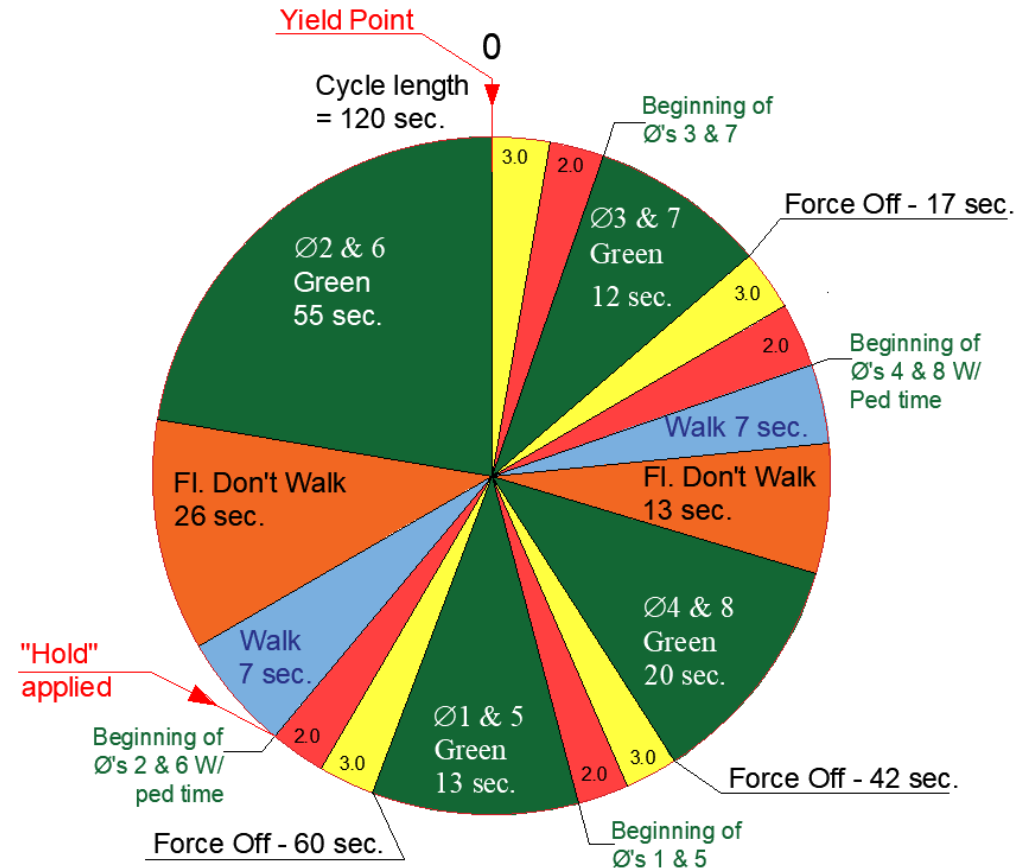

Traffic Signal Coordination

In order to achieve coordination, you must understand several terms that are used:

- **Permissive Window / Yield Period** – A period of time that begins at the yield point and allows the controller to service any opposing calls.
 - The controller runs “free” during this period
 - The controller may service late arriving vehicles during the current cycle. Otherwise, vehicles would have to wait for the next cycle before being serviced.
 - A permissive window that allows too much time may disrupt coordination

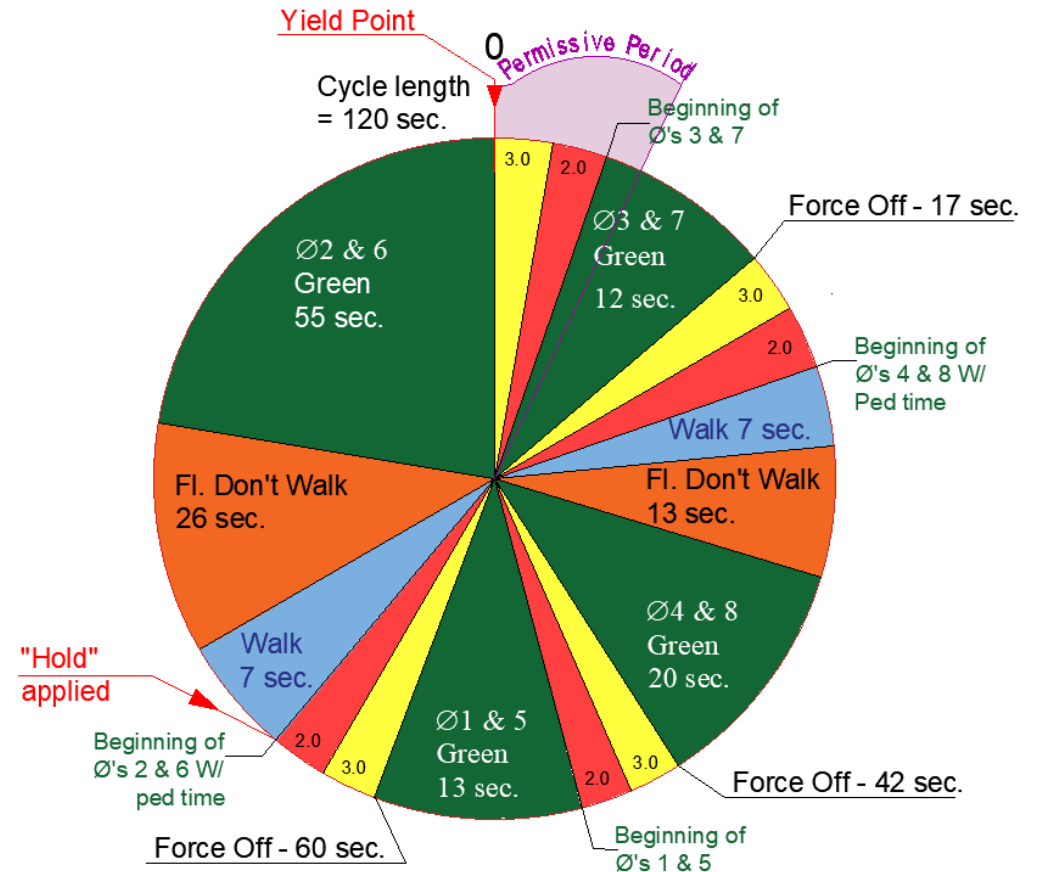

Traffic Signal Coordination

In order to achieve coordination, you must understand several terms that are used:

- **Offset** – Offset is the time relationship, expressed in seconds or percent of cycle, determined by the difference between a defined point in the coordinated green and a system reference point, which can be observed on corridors with visibility of the signals.
 - In this example, each signal is 12 seconds of travel time apart. Each signal's coordinated green is differed by the cumulative offset time as measured from the system reference point.
 - This allows the motorist to progress through the corridor *at the posted speed limit* without stopping at numerous signals.



Traffic Signal Coordination

In order to achieve coordination, you must understand several terms that are used:

To achieve the **offset** at the second intersection, the cycle chart on the right has been offset by rotating the "zero" point 12 seconds beyond the left cycle chart.

In this example, each subsequent cycle chart is rotated by an additional 12 seconds to establish the offset for that intersection.

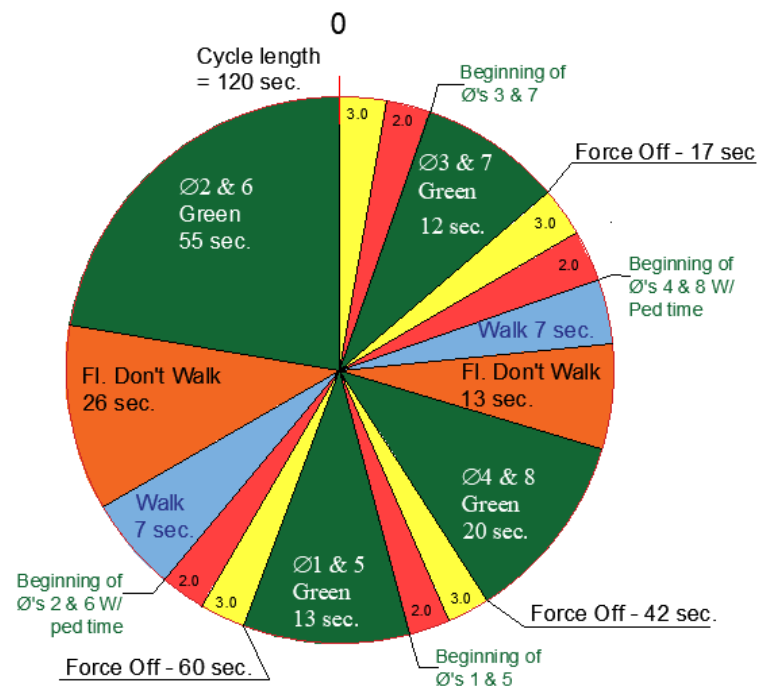

The first signal at the system reference point

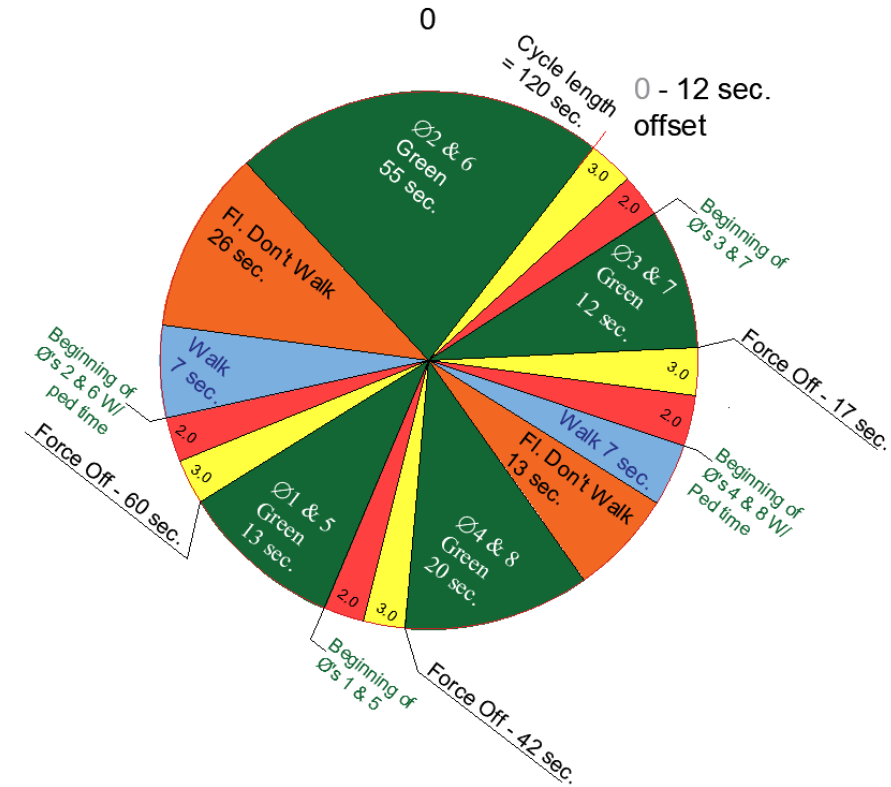

The second signal after the system reference point

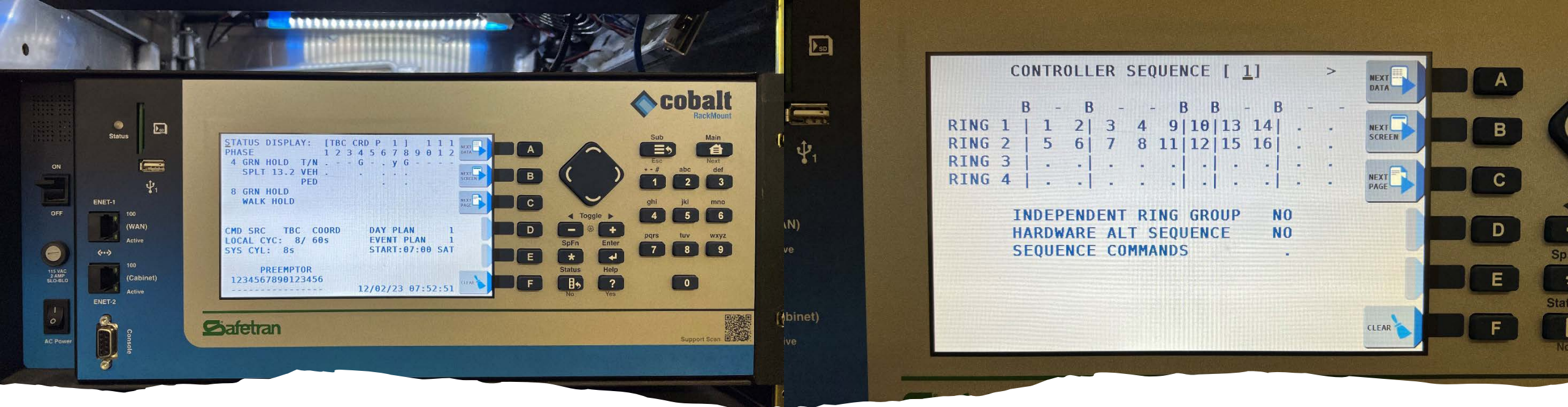

Controller Configuration

- **Configure the controller:**

- Program the ring, channel output assignments, start up sequence, and other configuration settings...
- Input the phase timings per the data base
 - Phases may have to be placed on recall while bench testing to cycle the controller
- Program or map the detectors to the appropriate input channels. Program any detector delays/extensions, CNA's, or recalls.
- Program the clock & calendar (all clocks need to be in sync for effective coordination), coordination plans, and time-of-day events.
- Program preemption and any telemetry functions.

Knowledge Check: Multiple Choice

Which signal operation has no predictable cycle length?

- a) A pre-timed operation
- b) A semi-actuated operation
- c) A fully actuated operation
- d) A coordinated operation

Knowledge Check: Multiple Choice

What green interval terminates a vehicle phase?

- a) Minimum Green
- b) Bike minimum green
- c) Passage
- d) Max Initial

Knowledge Check: Multiple Choice

Which phase interval cannot be shortened or forced off?

- a) Maximum I
- b) Yellow Clearance
- c) Flashing Don't Walk
- d) Passage

Knowledge Check: Multiple Choice

A background cycle can best be described as:

- a) An artificial cycle length developed by the preemption plan
- b) An artificial cycle length imposed on the controller
- c) An artificial cycle length determined by the detection plan
- d) The actual cycle length determined by the vehicle and pedestrian inputs.

Knowledge Check: Multiple Choice

How is a split different from a force off?

- a) A split determines the amount of green time for a phase, while a force off determines the total phase time
- b) A split determines the amount of time for a phase, while a force off determines the amount of green time
- c) Both splits and force offs determine the phase cycle.
- d) A force off determines the clearance times, while a split determines the green time for a phase.

Knowledge Check: Multiple Choice

What happens at the yield point?

- a) The offset begins.
- b) The permissive period ends.
- c) The hold is dropped.
- d) The coordinated red clearance interval ends

IMSA Traffic Signal Field Technician II

Session 5: Detection Systems



Advancing the Future of Public Safety

Detection Types & Modes of Operation

**Vehicle and pedestrian detection systems accomplish one thing...
they send data or inputs (0 VDC logic ground) into the traffic signal controller.**

Vehicle detection technologies share some things as well:

- Vehicle detectors *are designed* to fail in an “ON” state so as not to trap any vehicles waiting for a green signal.
 - Some of the newer technologies need to be programmed as such.
- All detection technologies have their specific advantages, however...
- They all have their disadvantages as well.

Intersections are unique, as are the needs of detection at each intersection. There is NO single detection system that is best suited for ALL needs.

Recalls

Recalls are operational options that sends internal inputs into the controller to place a constant demand for service on any given phase(s).

- The controller will service recalls in every cycle regardless of vehicle or pedestrian demand.
- There are multiple types of recall. The three most common are:

Minimum (Min) recall: Minimum recall puts a demand for vehicle service on any given phase(s). Once the controller services the phase, it begins timing minimum GREEN interval.

Maximum (Max) recall: Max recall puts a demand for vehicle service and forces the controller to time the MAX I, II or III interval. The phase(s) will remain in a GREEN condition for the maximum amount of time regardless of traffic flow.

Pedestrian (Ped) recall: Ped recall puts a demand for pedestrian service on a phase(s) and forces the controller to time the 'Walk' and the Flashing 'Don't Walk' intervals each time the controller services the phase(s).

Recalls

Recalls are operational options that sends internal inputs into the controller to place a constant demand for service on any given phase(s).

- There are multiple types of recall. A few additional common recalls are:

Call to non-actuate: A programmed setting in the controller used on the non-actuated phases to force the controller to always service those phases regardless of traffic flow.

- Call to non-actuate may include min green, max intervals, and ped times.
- Typically, only used during coordinated operations.

Soft recall: The soft recall parameter causes the controller to place a call for vehicle service on the phase in the absence of a serviceable conflicting call. When the phase is displaying its green indication, the controller serves the phase only until the minimum green interval times out. The use of soft recall ensures that the major-road through phases will dwell in green when demand for the conflicting phases is absent.

- The phase can be extended if actuations are received.
- If no demand is present on soft recall phases, they will be skipped during demand elsewhere.

Detection Modes of Operation

All types of vehicle detection have several operational modes in common:

- **Pulse vs. Presence**

- **Pulse** is a detector setting that produces a short output pulse when detection occurs. Advanced vehicle detectors are typically set to pulse mode and are designed to count vehicles and extend timing intervals.
- **Presence** is a mode that will maintain the call to the controller as long as any vehicle remains in the detection zone. Once the vehicle leaves the detection zone, the call to the controller is dropped. Stop bar detectors are typically set to presence mode.

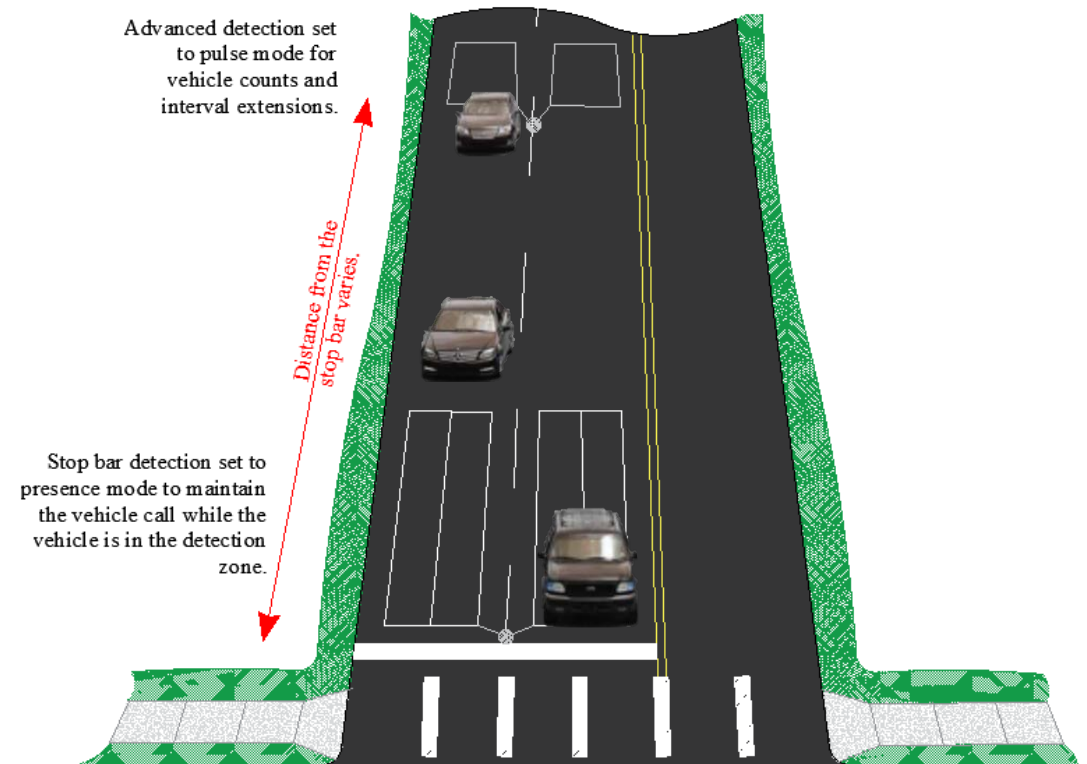

Detection Modes of Operation

All types of vehicle detection have several operational modes in common:

- **Lock vs. Non-lock**

- **Lock** is a controller setting that maintains the vehicle call until the controller services that phase, whether a vehicle is there or not. Lock is useful for point detectors placed at the stop bar. There are two types:
 - **Red lock** only locks the call if the phase is in a red condition.
 - **Yellow lock** locks a call if the phase is not in a green condition.
- **Non-lock** is a controller setting where the active vehicle call is only held while the vehicle is in the detection zone. Stop bar detectors should be set to “non-locking” to maintain signal efficiency.

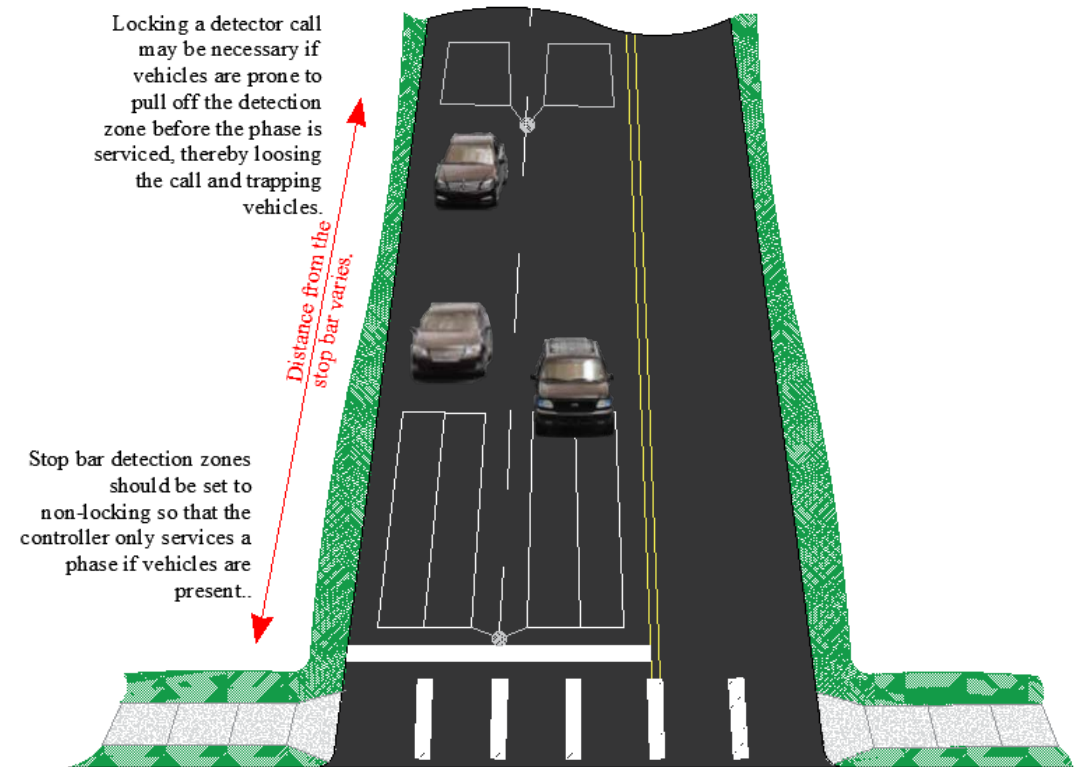

Detection Modes of Operation

All types of vehicle detection have several operational modes in common:

- **Delay vs. Extend**

- **Delay** is a setting that delays the activation of the detector input from 0 to 30 seconds. Delay is useful for a right lane approach to an intersection where many motorists make a right turn on red. It is not efficient to service a phase for a vehicle that is no longer present.
- **Extend** maintains an active vehicle call from 0 to 7.5 seconds after the vehicle has left the detection zone. Extend may be effective for an approach to an intersection with limited visibility or an unusual lane geometry.

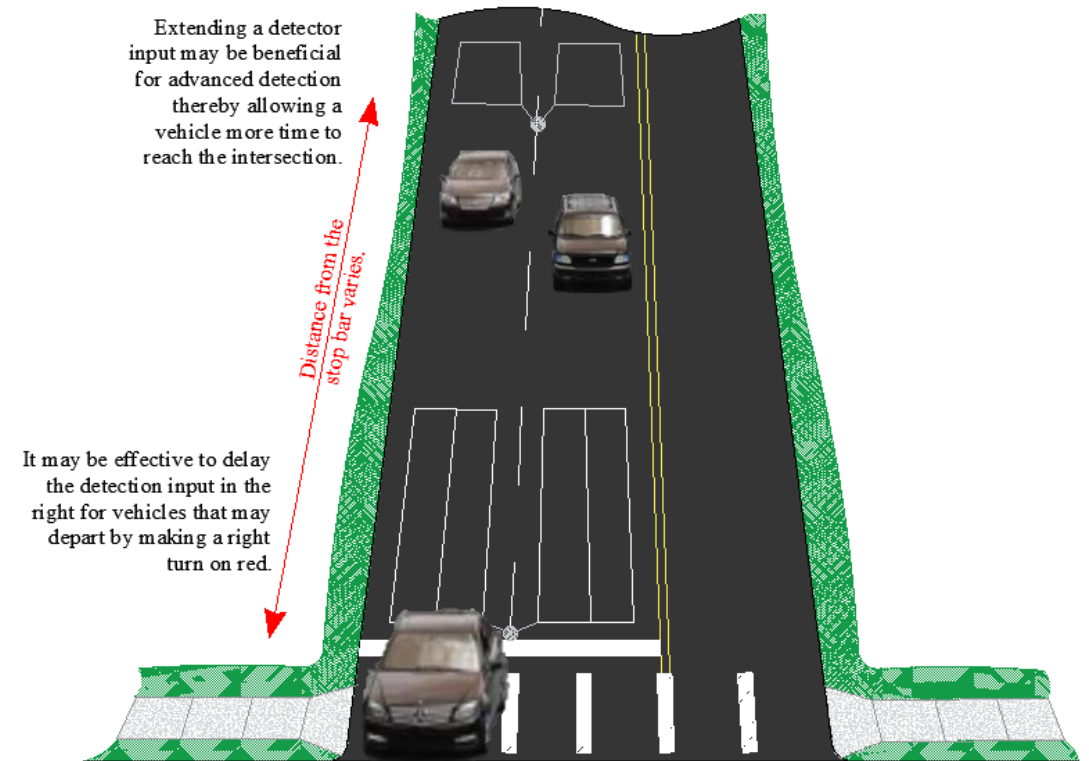

Detection – Phase assignments

Today's controller and detection technology offers many more options than we had before.

- In the early days, detection inputs were simply hard wired into specific channels within the cabinet. We had to work with what we were given.
- Today, we can program or "map" detector inputs to any channel we like and for any purpose we choose.

Cabinets and controllers arrive from the manufacturer with predefined detector assignments.

- Typically, detector #1 is programmed for phase 1, detector #2 for phase 2 and so on...
 - Typical detector assignments made it easier to configure a cabinet and run an intersection with minimal effort.

The good news is that we are not stuck with those assignments.

Detection – Phase assignments

Detector mapping is a feature available in today's controllers and non-intrusive detection technologies.

- Detectors are assigned to specific phases to detect the presence or movement of vehicles or pedestrians.
- The controller can service those phases and adjust the timing accordingly to meet the demand.
 - The controller can extend passage intervals, extend clearance intervals to help with dilemma zone protection, extend pedestrian clearance intervals
- Detectors can be programmed to call multiple phases
- Detectors can be "gated" together to achieve detection for special circumstances

VEHICLE DETECTOR ASSIGNMENT PLAN [1] v

	PRIMARY	ADDITIONAL
DET	PH	12345678 90123456
1	1
2	2
3	3
4	48.....
5	5
6	6
7	7	..3.....
8	8
9	2
10	2
11	4
12	4

Navigation buttons: NEXT DATA, NEXT SCREEN, NEXT PAGE, CLEAR

Detection & Adaptive Traffic Control

Developing technologies in detection and controllers has led to “Adaptive Traffic Control Systems.”

- Adaptive control systems can use many types of detection technologies.
- Together, with complex algorithms in the software, adaptive systems can optimize the flow of traffic, not only at one intersection but many intersections throughout many corridors. Adaptive systems can:
 - Optimize traffic signals for *all* road users; vehicles, bicycles and pedestrians.
 - Responds to traffic conditions in real time, for example; high volumes, accidents, construction, weather events...
 - Adjust the cycle length as necessary to meet the demands of approaching traffic thereby creating a smoother flow of traffic.
 - Continuously distribute green times as necessary across all phases.
 - Classify vehicle types.

Detection Types

**Vehicle and pedestrian detection systems accomplish one thing...
they send data or inputs (0 VDC logic ground) into the traffic signal controller.**

We have many different types of detection technologies available for traffic signals:

Intrusive Detection – *disrupts the roadway surface during installation*

- Inductive Loops
- Magnetometers
- Magnetic
- Piezo Electric

Non-Intrusive Detection – *Installation of devices is above or at the side of the roadway*

- Microwave Radar
- Ultrasonic
- Infrared Detection
- Video

Non-intrusive detection devices “learn” the background image so it can differentiate between something that enters the detection zone and the static background.

Detection Systems - Loops

Advantages:

- Reliable detection of vehicles, including motorcycles and bicycles *if tuned properly*.
- Can differentiate between various vehicle sizes and lengths.
- Can detect vehicles in all weather conditions.

Disadvantages:

- Requires cutting into the pavement to install the loops, thereby compromising the roadway surface.
- Installation is relatively inexpensive.
- Maintenance can be costly and time-consuming.
- As the pavement moves, so does the loop, which can cause damage or a complete failure.

VEHICLE DETECTOR ASSIGNMENT PLAN [1] v

	PRIMARY	ADDITIONAL
DET	PH	12345678 90123456
1	1
2	2
3	3
4	48.....
5	5
6	6
7	7	..3.....
8	8
9	2
10	2
11	4
12	4

Navigation buttons: NEXT DATA, NEXT SCREEN, NEXT PAGE, CLEAR

Loop Detection – Wiring & Faults

A multimeter will test the continuity of the loop

A megohmmeter will test the integrity of the insulation on the conductors.

A loop tester/analyzer will test the individual functions of the loop itself:

- Inductance & Change of Inductance or " ΔL " (*delta L*)
- Frequency
- Q factor
- Resistance
- Some devices may have an integrated megohmmeter and a loop locator.

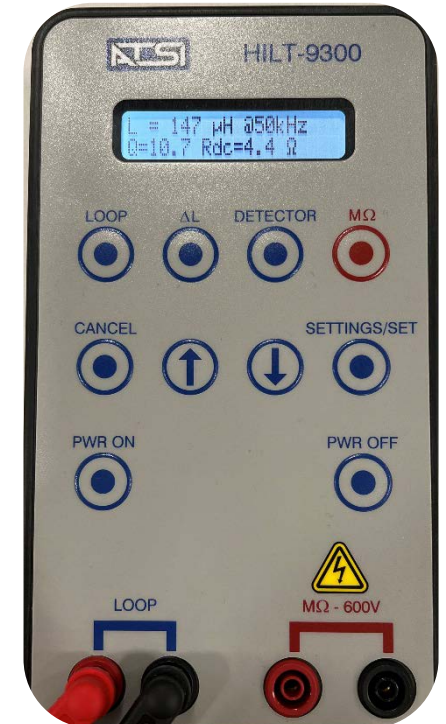

Loop Detection – Wiring & Faults

Loops should only be spliced once at the homerun cable in the nearest pull box at the side of the roadway.

Splices should be soldered and waterproofed.

For operational and troubleshooting purposes, each loop should return to the cabinet on its own twisted & shielded pair of homerun wires.

If wiring is not functioning properly:

1. Visually inspect the roadway for signs of pavement damage, i.e., cracking, movement, sharp corners, heaving, bad sealant, roto-milling, etc.
2. Check the loop splices for corrosion or moisture.
3. Isolate the loop from the homerun cable and test each individually.



How should multiple loops be connected?

When you connect loops to a homerun cable, you are making an electrical circuit.

- What type of circuit best suits your needs?
- Series or Combination

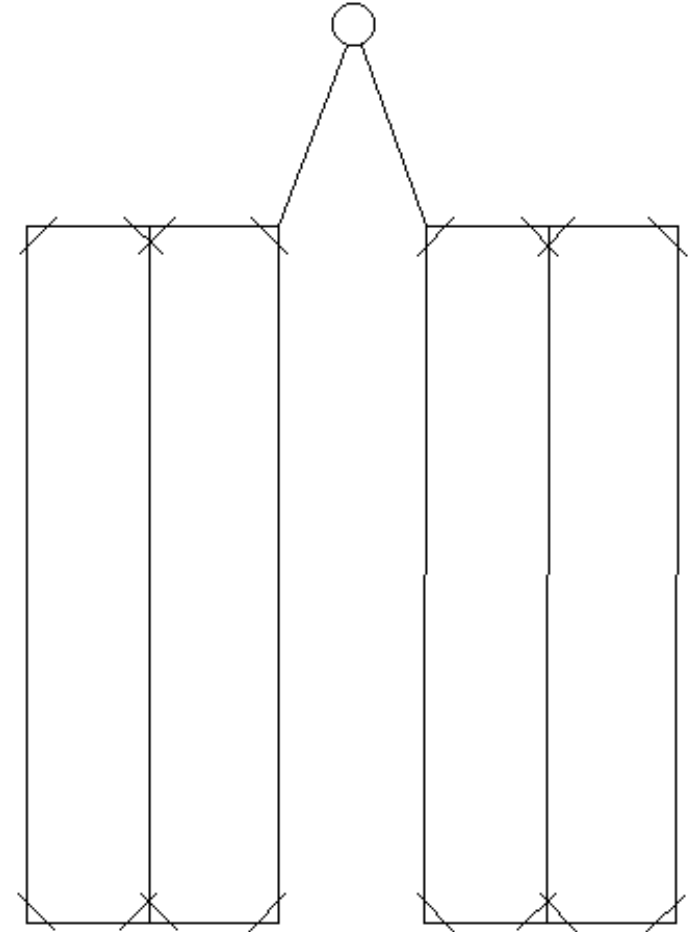

2 - 6 x 40 Quadrupole loops
with 200' lead-in to the
cabinet.

Operational Concerns

Operational Concerns:

- **Crosstalk** – electrical interference causing false calls, multiple calls, or no call situations.
 - Adjacent loops / lead-in cables should be set at different frequencies to avoid crosstalk
 - Electrical filters in the detector should be turned “on” in case overhead powerlines are interfering with the loop
 - Crosstalk may also be solved by grounding the drain wire in the homerun cable(s) to a ground bus in the cabinet
- **Splashover** - a loop in one lane detecting a vehicle in an adjacent lane.
 - Loop sensitivity should be turned down if it is detecting vehicles in adjacent lanes
 - The width of the loop may need to be cut smaller, so the outside edge of the loop isn't too close to the adjacent lane.
 - Too many turns of wire causing high loop inductance



Detection Systems – Magnetometers

○ Advantages:

- Accuracy
- Real-time Monitoring
- Low Maintenance
- Cost-effectiveness
- Good detection in bridge decks or near manhole covers and rails

○ Disadvantages:

- Intrusive Detection, I.E., pavement issues
- Sensitivity to External Magnetic Interference; I.E. powerlines
- Limited Detection Range



How Magnetometers Work

- The Earth's **magnetic flux lines** permeate through the ferrous metals in the vehicle; engine, frame, drive train...
- The **Earth's flux lines** add to the **flux lines** already in the ferrous metals in the vehicle.
- These flux lines converge to form a concentration of flux lines under the vehicle, otherwise known as a "***magnetic shadow***".
- Magnetometers detect a vehicle when it sees the magnetic shadow.



Detection Systems – Piezo Electric

○ Advantages:

- Extremely Accurate
- Low Maintenance
- Cost-effectiveness
- Weigh vehicles while in motion
 - No more truck stops

○ Disadvantages:

- Intrusive Detection, I.E., pavement issues
- Limited Detection Range
- Must be installed within a ¼" of the roadway surface



Detection Systems – Microwave Radar

○ Advantages:

- Volume, occupancy, & speed data
- Accuracy
- Side-fire or front-fire detection
- Weather Independence
- Detect up to 8 lanes with one unit up to 200' away
- Can see over barrier walls and guardrails
- Low Maintenance & life-cycle costs

○ Disadvantages:

- High initial purchase & setup cost
- False calls from echo's
- Occlusion can be an issue
- Very heavy snow on the face of the unit may compromise detection
- Limited Information



Detection Systems – Ultrasonic

○ **Advantages:**

- Non-intrusive
- Low Maintenance
- Low-cost replacement option for a single loop
- Side fire or above roadway detection
- Good option during roadway construction where lane shifts are common

○ **Disadvantages:**

- Single lane detection only
- Maximum detection distance is 22'



Detection Systems – Infrared

o Advantages:

- Non-intrusive
- Able to “see” in many conditions such as: darkness, sunlight glare, fog
- Can detect large and small vehicles, bicycles and pedestrians
- May best complement other detection sensors such as:
visible video, radar, LIDAR...
- Low maintenance once set up

o Disadvantages:

- High initial purchase and set up cost
- Hot spots could make false calls



<https://www.flir.com/>

Detection Systems – Video Cameras

○ **Advantages:**

- Comprehensive Data
- Versatility
- Integration Potential
- Flexibility
- Multi-Purpose Usage

○ **Disadvantages:**

- High initial purchase & setup cost
- Weather Sensitivity
- Sunlight glare issues
- Flat light/contrast issues
- Line-of-Sight Limitations (occlusion)
- Privacy Concerns



Detection Systems – Camera Installation

Mast arm Vs. Luminaire arm???

Mast arm – Lower height = a flatter camera angle, more aligned with the flow of oncoming traffic. More likely to see the horizon.

Luminaire arm – Higher installation = a steeper camera angle (less chance of seeing the horizon), shooting across the lanes of traffic where occlusion could be a problem.



General rules for camera installation:

Camera placement:

- For every 1 foot of vertical measurement, you can expect to see 10 feet horizontally.
 - A camera 25' in the air should see 250' in distance.
- Mount the camera to minimize occlusion. Occlusion is something in the field of view blocking the view of the vehicles.
- Mount the camera as high as possible to create a steeper downward angle to minimize seeing the horizon. You do not want to see any sky in the field of view!
- Move the sunshade as far forward as possible
 - Glare & sunshine compromises the image.
- Focus the camera for a clear and sharp image.
- Make sure all the mounting hardware is tight and secure.



<https://www.slocity.org/>

**Detection Systems –
Camera Installation**

Vehicle Detection System Faults



Common TS1 Faults

- Loops with amplifiers or cards/processors
- Radar, Video cards, and processors
- Back panel inputs and special inputs through the "D" connector
- Physical connections between the detection panel and the detector rack
- Physical connections between the detection rack and the controller



Common TS2 Faults

- Card racks and associated equipment
- Change of inductance, Open Loop & Shorted loop
- Detector Diagnostics - "No Activity", "Maximum Presence", "Erratic Output"
- Detector BIU to the controller
- Detector BIU enabling
- Mapping BIU input to controller input

Verify Controller Inputs/Outputs

- ✓ Review **cabinet blueprints**.
- ✓ Watch the controller display screen as vehicles approach each phase.
- ✓ Look for constant detection inputs due to faulty detectors.
- ✓ Confirm the system has a proper **voltage**.
- ✓ Inspect connections and fuses.

INPUT FUNCTIONS				v	
DETECTOR	12345678	INPUTS	R1	R2	
VEH DET	XX.....X	STOP TIME	.	.	NEXT DATA
PED DET	RED REST	.	.	NEXT SCREEN
		FORCE OFF	.	.	NEXT PAGE
PHASE	12345678	INHIBIT MAX	.	.	
VEH OMIT	MAX II	.	.	
PED OMIT	OMIT RED CL	.	.	
HOLD	PED RECYCLE	.	.	
INPUTS					
MINRECALL	.				
COORD/FREE	.	PREEMPTS	I/O	MODE	SEL
INTER ADV	.	2 . 4 .	A .	B .	C .
MCE	.	5 . 6 .			
WLK RST MOD	.				

OUTPUT FUNCTIONS			
PHASE	12345678	OVERLAP	ABCD
RED	XX..XX..	RED	X.X.
YELLOW	YELLOW
GREEN	...X...X	GREEN
DONT WALK	XXXXXXXX		
PED CLEAR	...X...X	MONITOR	
WALK.....	CVM	.
PH CHECK.	XXX.XXX.	FM	.
PH NEXT..	FL	X
PHASE ON.	...X...X		
	R1	R2	
STAT A	.	X	
STAT B	X	.	
STAT C	.	.	

Verify Detector Card/Processor

Examine **the indicator lights** to identify any detector faults. A stuck or flashing light may be an indication of a faulty detector.

Inspect detection **zones** to confirm proper function; are vehicles being detected in the detection zones?

Replace **faulty equipment** and verify **detector assignments** if vehicles are not detected in the correct zone.



Reinitialize Systems

Reinitialize systems if **modifying detection system** programs.

Reinitialize systems if **adding new detection devices**, such as cameras, loops or pucks.



Verify Correct Operation

Inspect the **controller display screen** as vehicles approach each phase to confirm the proper function of the detection system.

Document all changes in the traffic maintenance log.

VEHICLE DETECTOR ASSIGNMENT PLAN [1] v

	PRIMARY	ADDITIONAL
DET	PH	12345678 90123456
1	1
2	2
3	3
4	48
5	5
6	6
7	7	..3.....
8	8
9	2
10	2
11	4
12	4

Navigation buttons: NEXT DATA, NEXT SCREEN, NEXT PAGE, CLEAR

Inspect Pedestrian Phase Assignments

Review **phase assignments** in cabinet blueprints.

Set phase assignments to run **pedestrian detection** from specific channels.

Inspect the **detectors** and make any necessary repairs.



Pedestrian Clearance Interval



Measure the **distance** of the pedestrian crosswalk.



Calculate the time it would take for a pedestrian to cross that distance using an average rate of **3.5 feet of road per second**.



Program the pedestrian clearance interval and **test** it.



Observe the full cycle of the pedestrian detection system to ensure proper function.

Emergency Vehicle Preemption (EVP) Detectors



Preemption disrupts the normal signal cycle to time selected phase(s) to service an emergency vehicle traveling through a signalized intersection.



<https://www.customtruck.com/>



<https://www.fedsig.com/>

It's a good idea to run a vehicle with an infrared optical emitter through the intersection to test & verify the operation of the preemption system.

EVP Entry/Exit Phases

EVP preemption is serviced on the higher input priorities:

- Inputs 1 & 2 – Railroad / Draw Bridge
- Inputs 3 – 6 – Emergency vehicles



Verify the preemption programming and input(s) to the controller



Verify **entry and exit phases** in the controller



Ensure that traffic signals change in the appropriate amount of time for emergency vehicles to pass safely through the intersection



Verify EVP Systems Function

Verify the EVP system to ensure proper operation and alignment of the signal and phase.

```

PREEMPT[PMT 3 INH 0 ]12/09/23|09:38:41
  PHASE 1 2 3 4 5 6 7 8 9 0 1 2 3 4 5 6
  PH STAT . N . Y . N . Y - - - - -
  VEH OVL 0 - 0 - - - - - - - - -
  PED OVL - - - - - - - - - - -
  VEH CALL 0 R 0 0 0 R 0 0
  PED CALL 0 0 0 0 0
  LC: 0s/ 0|SYS CYL: 0s|COS | FREE
  R1/PH 4|R2/PH 8|R3/PH .|R4/PH .
  DWL/CYCL|DWL/CYCL|DWL/CYCL|DWL/CYCL
  YEL- 2.4|YEL- 2.4|INACTIVE|INACTIVE
  PREEMPT |PREEMPT |
  IEEE STAT:NOT ENABL
  FUNCTION 1 2 3 4 5 6 7 8 9 0 1 2 3 4 5 6
  PMT/TSP - - A - - - - - - - - -
  LP FLAG . . . . .
  
```

```

PREEMPT[FREE-DEFAULT ]12/09/23|09:39:03
  PHASE 1 2 3 4 5 6 7 8 9 0 1 2 3 4 5 6
  PH STAT y G . . y G . - - - - -
  VEH OVL y - y - - - - - - - -
  PED OVL - - - - - - - - - - -
  VEH CALL R . R R R . R R
  PED CALL R R R R
  LC: 0s/ 0|SYS CYL: 0s|COS | FREE
  R1/PH 2|R2/PH 6|R3/PH .|R4/PH .
  NOT PMT |NOT PMT |NOT PMT |NOT PMT
  GRN HOLD|GRN HOLD|INACTIVE|INACTIVE
  MAX1 0|MAX1 0|
  IEEE STAT:NOT ENABL
  FUNCTION 1 2 3 4 5 6 7 8 9 0 1 2 3 4 5 6
  PMT/TSP - - - - - - - - - - -
  LP FLAG . . . . .
  
```

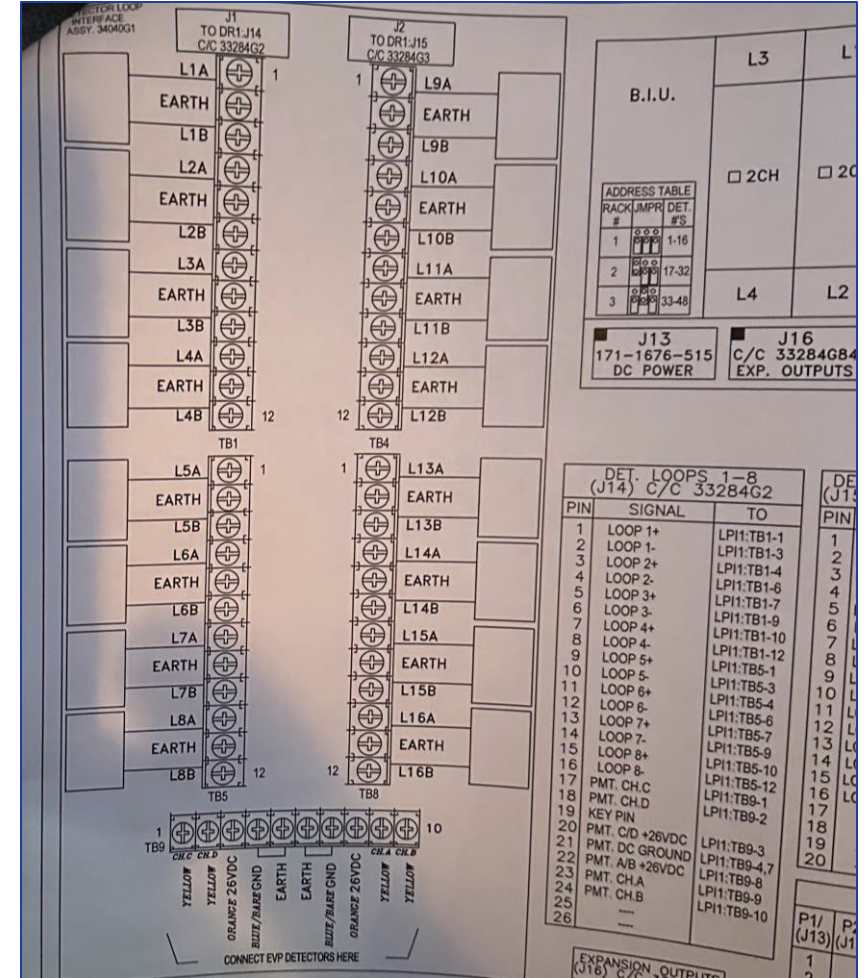

Railroad Preemption - Entry/Track Clearance & Exit Phases

The MUTCD section 8D.07, 03 in rail traffic detection says:

Flashing-light signals shall operate for at least 20 seconds before the arrival of any rail traffic, except as provided in Paragraph 4 of this Section...

- As the train approaches, the controller will begin the railroad preemption sequence



```

PREEMPT[PMT 1 INH 0 ] 01/31/24|00:24:37
12345678 90123456      PREEMPTION
PHS  . . . . .Y..  .-----  1 A 2 - 3 - 4 -
OVL  0000RR--  -----  5 - 6 - 7 - 8 -
POVL -----  -----  9 - 10- 11- 12-
VCAL 00000000 I      13- 14- 15- 16-
PCAL  . R . R

      PMT STRT      PMT STRT  EVENT PL      2
      . RED REST   . INACTIVE  TIMING PL     1
                                      SEQUENCE       1

      PMT STRT      PMT STRT
6 YEL- 1.2 . INACTIVE      OLC Y 1.2
FORCEOF
  
```

NEXT DATA

NEXT SCREEN

NEXT PAGE

CLEAR

Railroad Entry / Clear Track / Exit Phases

As the train approaches the highway-rail grade crossing:

- The controller services the “Track Clearance Phases”
 - Conflicting vehicle phases are forced off
 - Track clearance phases must be serviced and timed so that vehicles may clear the crossing *before the gates come down*



PREEMPT[PMT 1 TRK 0] 01/31/24|00:24:41

	12345678	90123456		PREEMPTION	
PHS	G-----	1 A 2 - 3 - 4 -		
OVL	0000GG--	-----	5 - 6 - 7 - 8 -		
POVL	-----	-----	9 - 10- 11- 12-		
VCAL	00000000	.	13- 14- 15- 16-		
PCAL	. R . R				

	CLR TRK		CLR TRK	EVENT PL	2
9 MGRN1	0	.	INACTIVE	TIMING PL	1
				SEQUENCE	1

	CLR TRK		CLR TRK		
.	RED REST	.	INACTIVE		

NEXT DATA
NEXT SCREEN
NEXT PAGE
CLEAR

Railroad Entry / Clear Track / Exit Phases

Once the train is in the highway-rail grade crossing:

- The controller services the “Railroad Permissive Phases”
 - These are vehicle phases that are allowed to run and do not conflict with the train
 - Phases that allow vehicles to approach the railroad crossing are not serviced



```

PREEMPT[PMT 1 DWL 0 ] 01/31/24|00:25:22
      12345678 90123456      PREEMPTION
PHS   ...G...G  .-----  1 A 2 - 3 - 4 -
OVL  000000--  .-----  5 - 6 - 7 - 8 -
POVL  -----  .-----  9 - 10- 11- 12-
VCAL  M00.00MC 0          13- 14- 15- 16-
PCAL  . R . .

      DWL/CYCL      DWL/CYCL  EVENT PL      2
      4 GRN REST  . INACTIVE  TIMING PL      1
      MAX1      9          SEQUENCE      1

      DWL/CYCL      DWL/CYCL
      8 MGRN1      4 . INACTIVE
      WK-1      3
    
```

NEXT
DATA

NEXT
SCREEN

NEXT
PAGE

CLEAR

Railroad Entry / Clear Track / Exit Phases

Once the train leaves the highway-rail grade crossing:

- The controller services the “Railroad Exit Phases”
 - These are vehicle phases that backed up while the train was in the crossing
 - These phases can be serviced with a longer, one-time Max interval to clear the traffic



<https://www.lohud.com/>

```

PREEMPT[PMT 1 EXITPHS] 01/31/24|00:25:47
12345678 90123456      PREEMPTION
PHS N..Y.N.Y .----- 1 A 2 - 3 - 4 -
OVL 000000-- ----- 5 - 6 - 7 - 8 -
POVL -----          9 - 10- 11- 12-
VCAL M0000M00 0       13- 14- 15- 16-
PCAL R R R R

EXITING          EXITING          EVENT PL      2
4 YEL- 2.1 . INACTIVE TIMING PL      2
MAX OUT          SEQUENCE          1

EXITING          EXITING
8 YEL- 2.1 . INACTIVE
MAX OUT
    
```

NEXT DATA

NEXT SCREEN

NEXT PAGE

CLEAR

Railroad Preemption & Vehicle Phasing

Here's what it looks like:

The MUTCD, 8D.09, (03) says:

If a grade crossing is equipped with flashing-light signals and is located 200 feet or less from an intersection or midblock location controlled by a traffic control signal, a pedestrian hybrid beacon, or an emergency-vehicle hybrid beacon, the intersection should be provided with rail preemption...

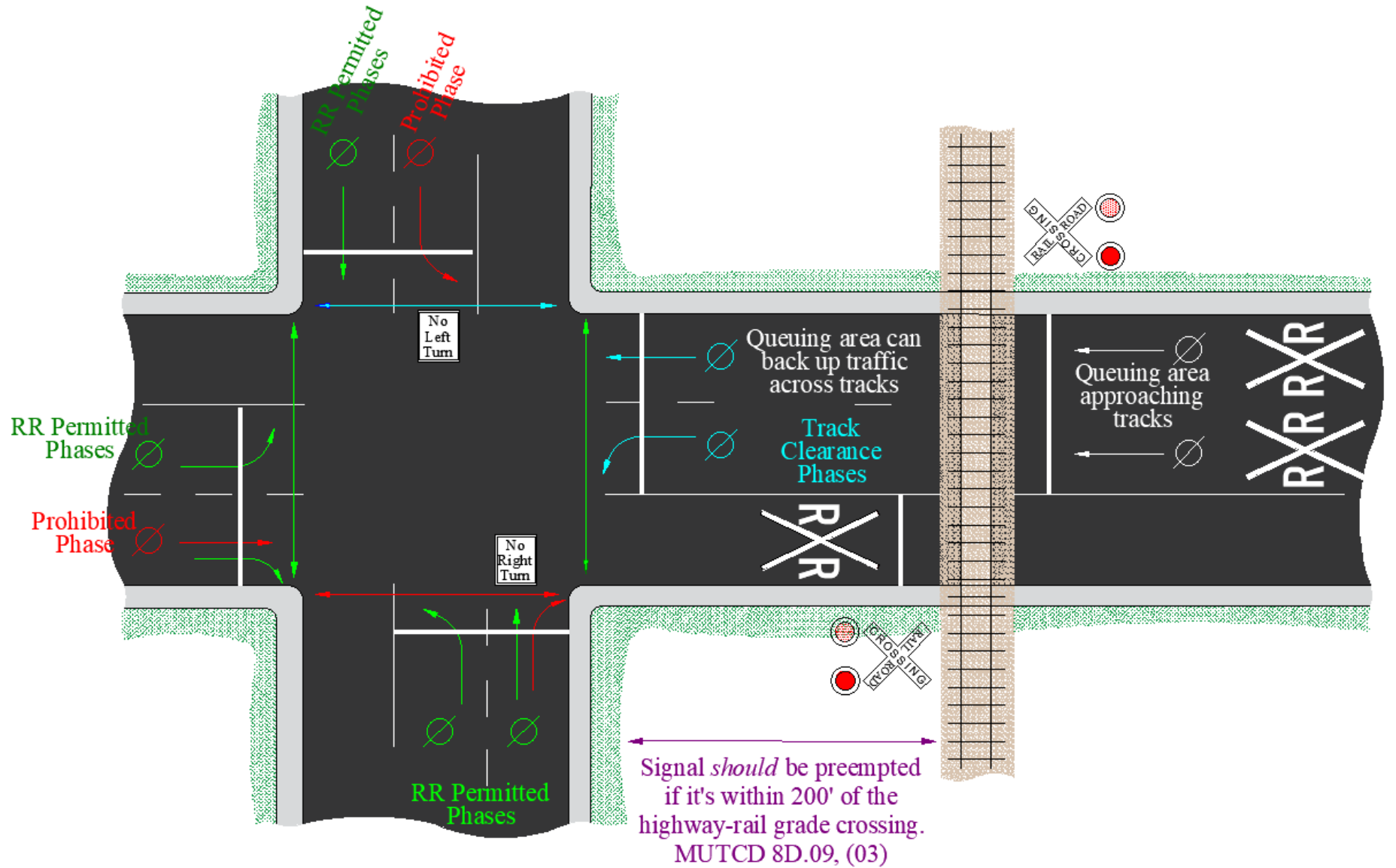

Draw Bridge Preemption & Vehicle Phasing

The same preemption idea holds true for draw bridges as well:

- 1) The bridge must be cleared
- 2) Permissive phases are serviced
- 3) Exit phases are serviced

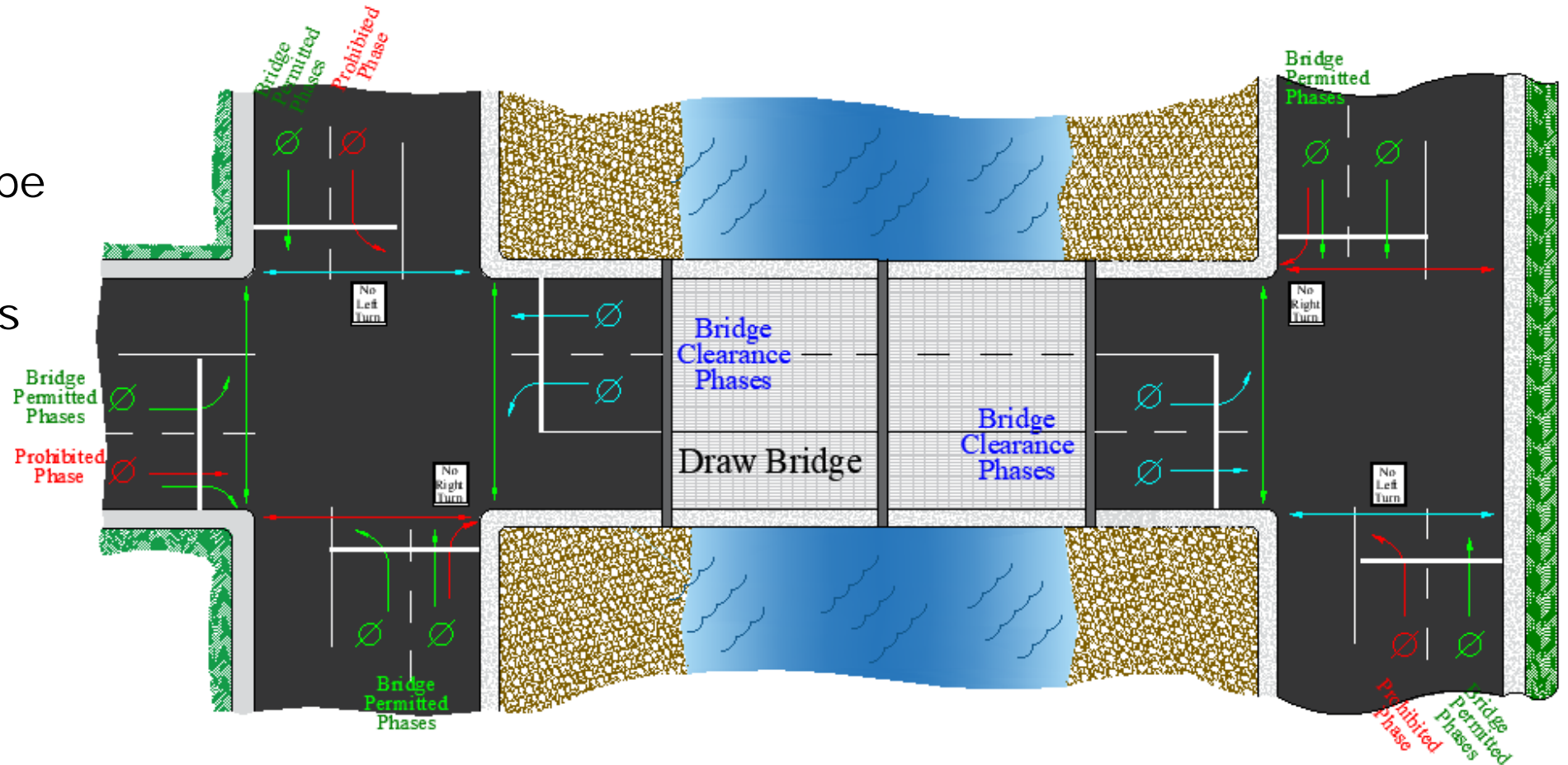

Priority Control for Public Transportation

Priority control is different from preemption:

- Priority control is serviced on the lower priority inputs, **7 thru 10** or so, depending on the controller manufacturer
- Priority control does *NOT* disrupt the normal signal sequence/cycle.
- Priority control gives limited consideration to public transportation vehicles:
 - Busses, light rail trains, cabs, ETC...
- It may allow an early green indication for the vehicle to enter the intersection before the vehicular traffic is given their green
- It may allow a trailing green indication so the vehicle may clear the intersection before conflicting traffic is serviced



<https://kygo.com/>



<https://pirg.org/>

Knowledge Check: Multiple Choice

A loop detector in the left turn lane should be set to:

- a) Pulse, locking, & delay
- b) Presence, locking, & extend
- c) Locking & presence
- d) Non-locking & Presence

Knowledge Check: Multiple Choice

What causes a loop detector to send an output to the controller?

- a) An increase of inductive reactance
- b) An increase of inductance
- c) An increase of frequency
- d) A decrease of frequency

Knowledge Check: Multiple Choice

Which of the following detector technologies does occlusion affect?

- a) Inductive loops
- b) Microwave Radar
- c) Magnetometers
- d) Magnetic detection

Knowledge Check: Multiple Choice

When must the technician reprogram the detector processor?

- a) After replacing burned-out fuses.
- b) After repairing the voltage in the system.
- c) After tightening connections.
- d) When adding new equipment, such as cameras and loops.

Knowledge Check: Multiple Choice

Which of the following disrupts the normal signal cycle?

- a) Preemption
- b) Priority control
- c) Precedence control
- d) Exit phases

Knowledge Check: Multiple Choice

What portion of railroad preemption is designed to clear the backed-up traffic?

- a) Track clearance phases
- b) Railroad exit phases
- c) Railroad permissive phases
- d) Entry phases

IMSA Traffic Signal Field Technician II

Session 6: Pedestrian Right-of-Way Guidelines
(MUTCD and ADA)



Advancing the Future of Public Safety

MUTCD – Audible Push Buttons

An audible push button system for traffic signals is a feature designed to assist pedestrians with visual impairments or other disabilities in safely crossing the street.

- It consists of a push button device located at pedestrian crossings that emits audible signals, typically in the form of chirps, beeps or speech messages.

According to MUTCD guidelines, Section 4K.03, pedestrian push buttons at traffic signals shall have an audible walk indication as a standard feature.

- 4K.03.09 & 4K.03.10: Audible walk indications shall be louder than ambient sound, up to a maximum volume of **5 dBA** louder than ambient sound.
- Automatic volume adjustment in response to ambient traffic sound level shall be a maximum volume of **100 dBA**.





MUTCD - Push Buttons

4K.01 - Accessible Pedestrian Signal (APS)

A device that communicates information about *pedestrian* signal timing in non-visual formats such as audible tones and/or speech messages and vibrating surfaces. (*push buttons for pedestrian signals*)

- Audible tones or speech messages shall be audible from 6 to 12 feet from the pushbutton

Tactile Arrow:

- Pedestrian push buttons shall have a tactile arrow with high visual contrast that is aligned parallel to the direction of travel on their associated crosswalks.

Vibrotactile: A method of communicating information by touch using a vibrating surface.

Calculating ped time:

- Per the MUTCD, the “Ped Clearance” time calculation is derived by dividing the length of the cross walk by an average walking speed of 3.5 ft/sec.
- The “Walk” time is added in addition to the “Ped Clearance” time.

ADA 308 – Reach / MUTCD - Height

ADA says the following:

- For forward and parallel approaches, the high reach shall be **48 inches** (1220 mm) maximum, and the low reach shall be **15 inches** (380 mm) minimum above the ground surface.

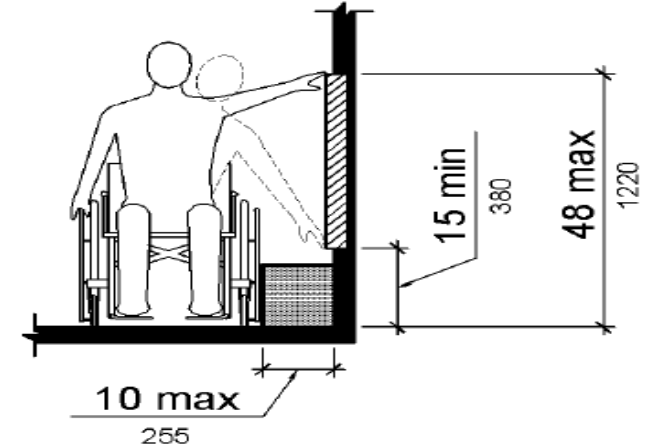
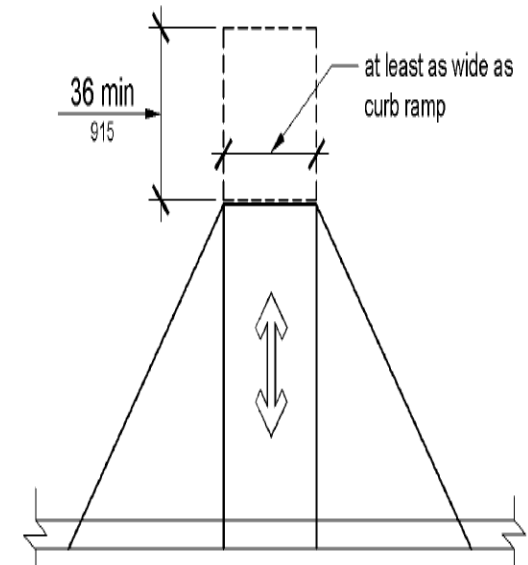

Figure 308.3.1
Unobstructed Side Reach

What does the **MUTCD** says about ped buttons:

- *Mounting height of approximately **3.5 feet**, but **no more than 4 feet** above the sidewalk.*
- The unobstructed side reach depth shall be a horizontal distance of **10"** maximum.
- Think about accessing a ped push button on a pole that has a vertical curb between the wheelchair and the pole.



Pedestrian Detectors:

- A. Unobstructed and accessible within one or more of the reach ranges specified in Section 308, and from a clear ground space as specified in Section 305, of the 2010 ADA Standards for Accessible Design;
- B. To provide a wheelchair accessible route from the push button to the ramp;
- C. On the side of the curb ramp which is farthest from the center of the intersection;
- D. Not greater than **10 feet** from the edge of the associated curb ramp which is farther from the center of the intersection;
- E. Not greater than **5 feet** from the outside edge of the marked crosswalk farthest from the center of the intersection;

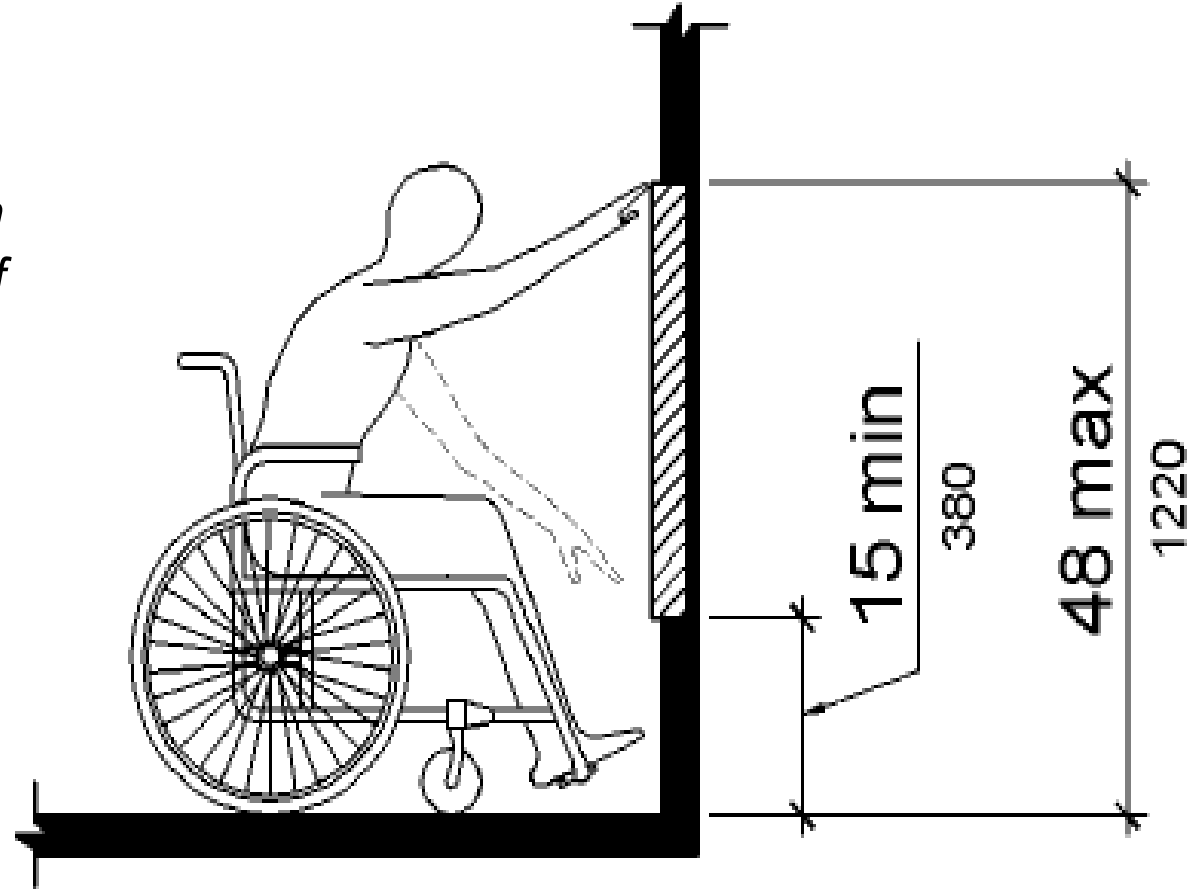

Figure 308.2.1
Unobstructed Forward Reach

Pedestrian Detectors:

- F. Not farther from the crosswalk than the stop line is, if present;*
- G. Between 1.5 and 6 feet from the face of the curb or from the outside edge of the shoulder (or if no shoulder exists, from the edge of the pavement);*
- H. With the face of the push button parallel to the crosswalk to be used;*
- I. At a mounting height of approximately 3.5 feet, but no more than 4 feet, above the sidewalk;*
- J. Allowing a minimum 4-foot continuous clear width for a pedestrian access route; and*
- K. Outside the flared side of the curb ramp, if present.*

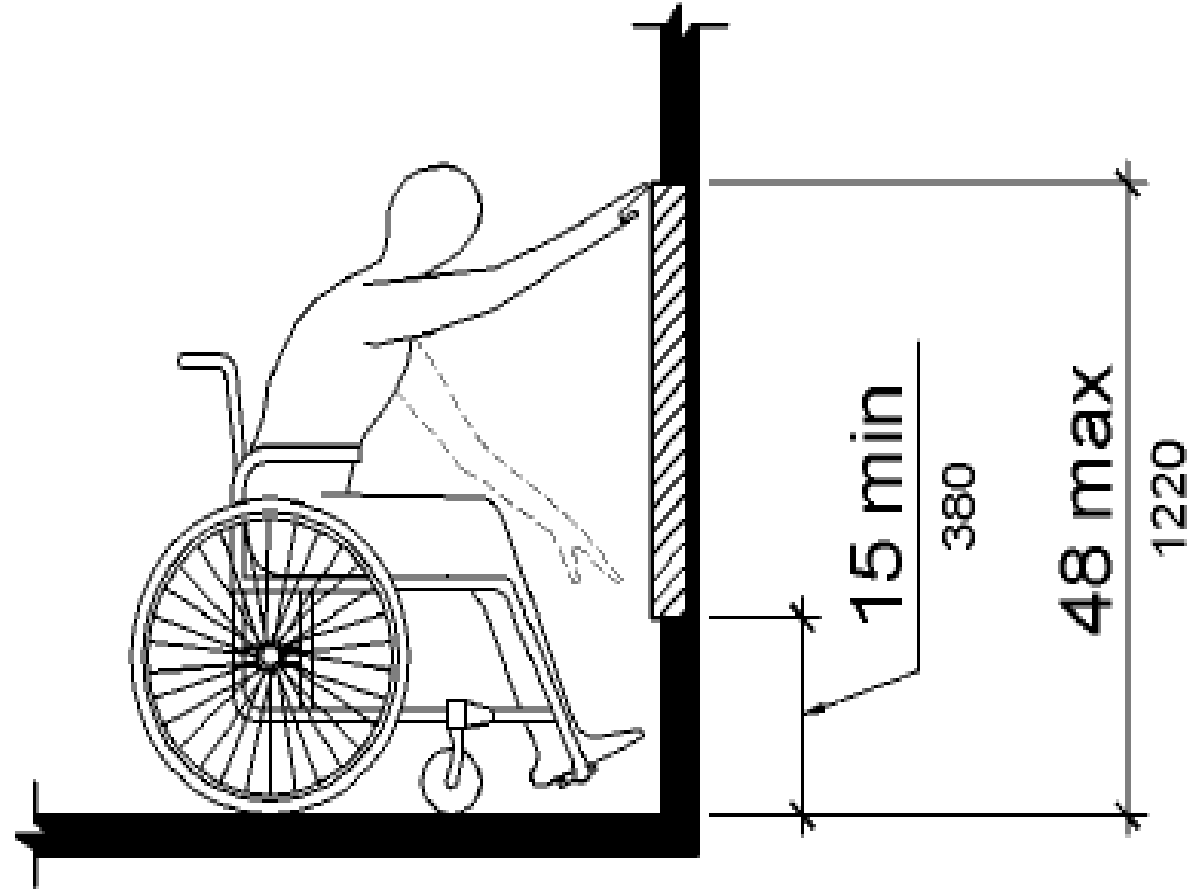

Figure 308.2.1
Unobstructed Forward Reach

MUTCD – Push Button Locations

MUTCD – Two Push Buttons on the same corner

- 41.05(07): Where two pedestrian push buttons are provided on the same corner, they **should** be separated by a distance of at least 10 feet.
- 41.05(08): Where there are physical constraints on a particular corner that make it impracticable to provide the 10-foot separation between the two pedestrian push buttons, the push buttons may be placed closer together or on the same pole.

Figure 4I-2. Preferred Push Button Location Area

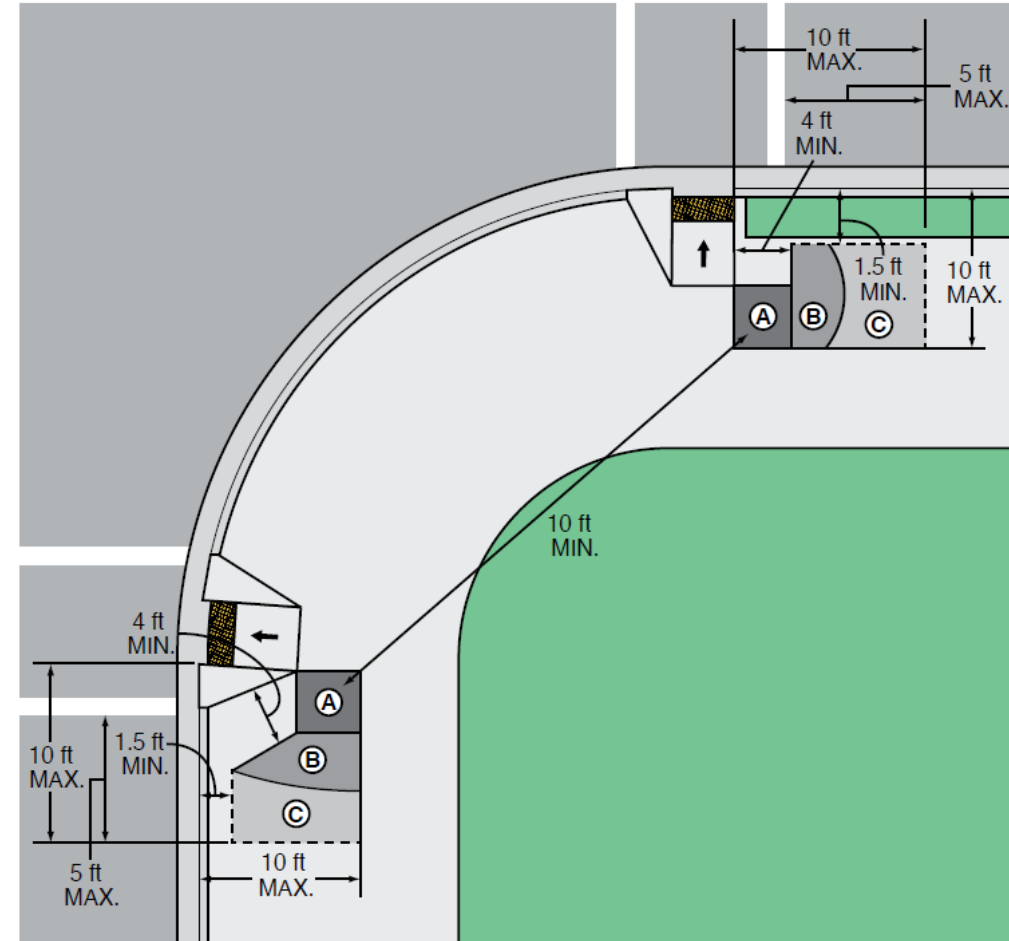

ADA 405 – Curb Ramps

ADA says the following:

- **Curb Ramps:** running slope shall not be steeper than **1:12**. The cross slope shall not be steeper than **1:48**.
- **Sides of curb ramps** may have flares or “wings”.
- **Landings** shall be provided at the tops of curb ramps when a change of direction is required to access a curb ramp.
- **Curb ramps:** shall have a detectable warning (truncated domes) the full width of the ramp by **24”** deep (surface area).

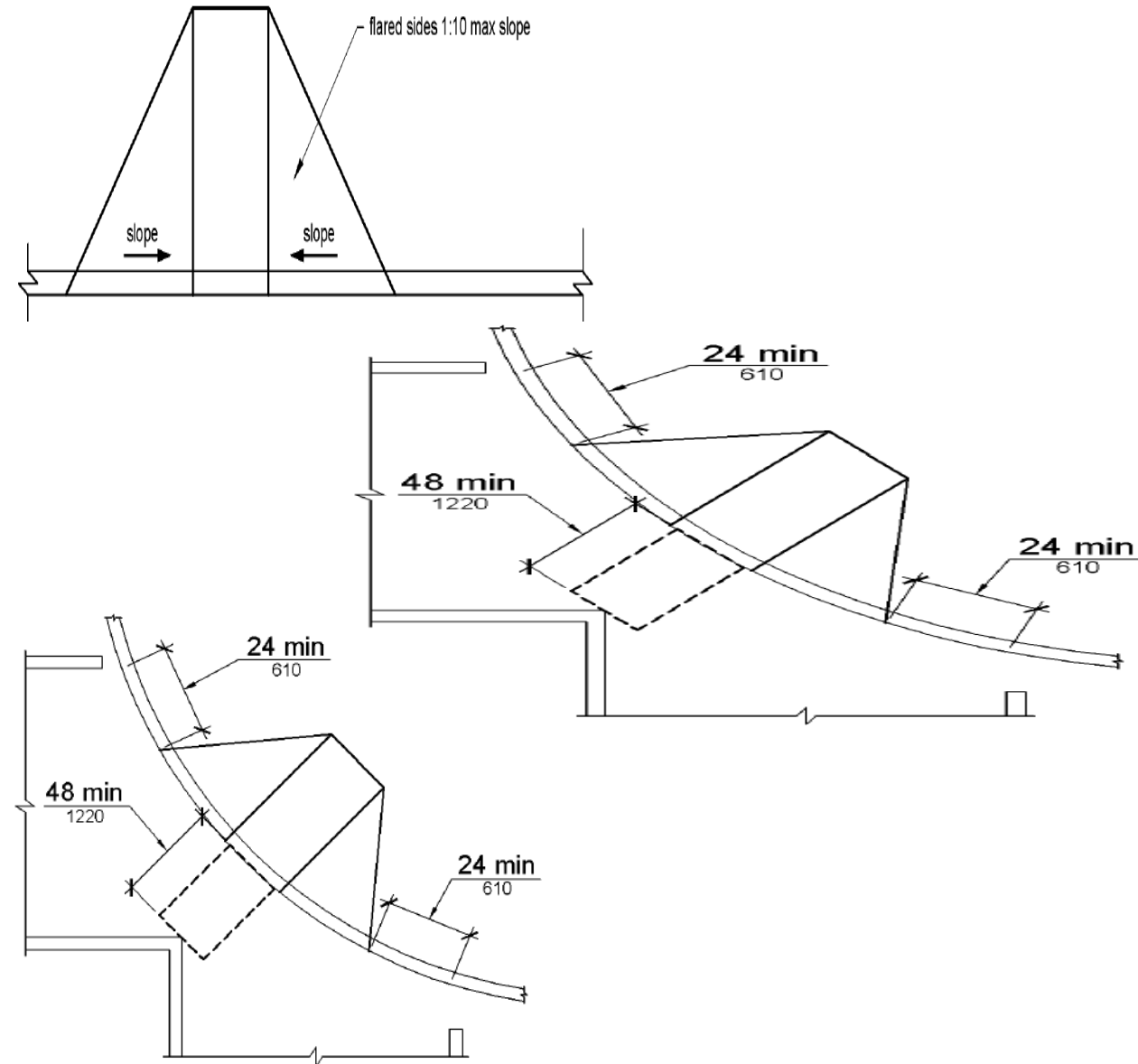

ADA 302 - Surfaces

ADA says the following:

Floor and ground surfaces shall be stable, firm, and slip-resistant.

- **A stable surface** is one that remains unchanged by contaminants or applied force, so that when the contaminant or force is removed, the surface returns to its original condition.
- **A firm surface** resists deformation by either indentations or particles moving on its surface.
- **A slip-resistant surface** provides sufficient frictional counterforce to the forces exerted in walking to permit safe ambulation.

Although ADA and the MUTCD doesn't specifically prohibit it, many public agencies will not allow pull boxes to be installed in a curb ramp.

A nonslip concrete surface



Knowledge Check: Multiple Choice

What is the maximum horizontal reach distance for a pedestrian push button?

- a) 10"
- b) 12"
- c) 14"
- d) 16"

Knowledge Check: Multiple Choice

According to the MUTCD, when two pedestrian push buttons cannot be separated by more than 10', what shall be done?

- a) The push buttons may be installed closer together or on the same pole.
- b) The push buttons shall not be placed greater than 5' from the outside edge of the marked crosswalk.
- c) Shall be placed between 15" and 48" on the pole.
- d) The audible 'walk' indication for each signal shall be a flashing light message.

Knowledge Check: Multiple Choice

Pedestrian push buttons shall have what features?

- a) Shall be orange with a vertical tactile stripe.
- b) Shall be round, with a raised "X" for the main street crossing and a "O" for the side street.
- c) Shall have a tactile arrow with high visual contrast that is aligned parallel to the direction of travel.
- d) Shall be a flashing light pulsing at 50 to 60 times a minute.

Knowledge Check: Multiple Choice

According to the MUTCD, the standard mounting height for a pedestrian push button is between _____ and _____?

- a) 24" (2ft) and 36" (3ft)
- b) 42" (3.5ft) and 48" (4ft)
- c) 45% of the calculated pedestrian clearance time.
- d) Shall be calculated by the EOR according to site conditions.

IMSA Traffic Signal Field Technician II

Session 7: Construction



Advancing the Future of Public Safety

Construction

During construction safety must be a top priority, be aware of dangerous conditions such as:

- Operator using equipment incorrect (i.e. using a bucket truck as crane)
- Contractor leaving trip hazards
- Sidewalk closed signs not in place during demolition
- Trench Hazards (i.e. contractor not using proper shoring or not putting up fencing)
- Bucket Trucks reaching over lanes
- Improper Road Closures
- Working during rush hour
- Working too close to power lines
- Underground utilities



Construction



Use the most up to date **construction plans** that are approved by a registered professional engineer



Inspect the field to ensure parameters **match** the construction plan.



Notify the engineer of any discrepancies before construction materials are ordered.



Junction/Pull Boxes

Many agencies call out the size and type of pull boxes to be used within their jurisdictions, as well as the specifications for the gravel base (aggregate).

- This will be locally dependent and can be based on soil content and water table depth.
- For example, some states call for:
 - Reinforced Polymer Concrete prefabricated pull boxes.
 - Provide ground boxes with the following inside minimum dimensions (width x length x depth) $\pm 1/4$ in.
- Type A = 11-1/2 in. x 21 in. x 10 in.
- Type B = 11-1/2 in. x 21 in. x 20 in.
- Type C = 15-1/4 in. x 28-1/4 in. x 10 in.
- Type D = 15-1/4 in. x 28-1/4 in. x 20 in.
- Type E = 11-1/2 in. x 21 in. x 16 in.

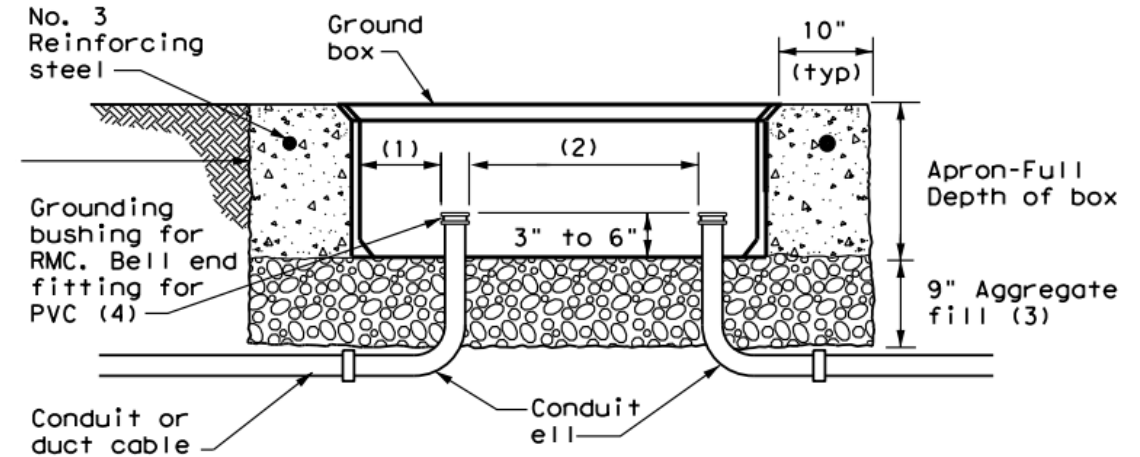

GROUND BOX DIMENSIONS	
TYPE	OUTSIDE DIMENSIONS (INCHES) (Width x Length x Depth)
A	12 X 23 X 11
B	12 X 23 X 22
C	16 X 29 X 11
D	16 X 29 X 22
E	12 X 23 X 17

Junction/Pull Boxes

- Are the ground boxes the correct size and in the correct locations called for by the plans?
- Ensure proper amount of gravel for the base?
- Does the pull box have the correct apron?
- Ensure cement/concrete is clear from edges and holes?
- Are all the pull box lids marked with proper wording?
- Do all the 90s have bell ends?
- Are all the cables properly tagged/phased?
- Are waterproof splices used in wet locations?
- Are all the 90s covered/foamed?
- Do the bolts properly fit?
- **NO SPLICING IN THE CONDUITS**

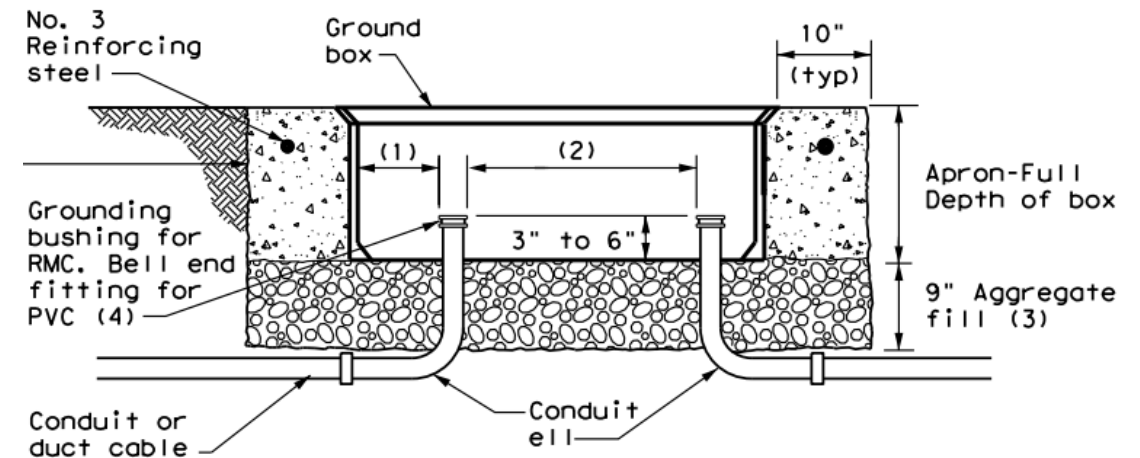
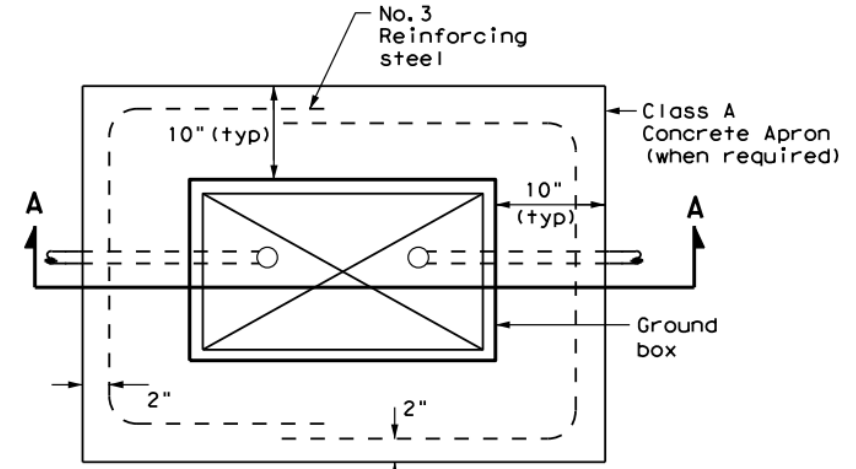

Junction/Pull Boxes

- Use an ohm tester to ensure the grounding system meets the standard of **25 ohms** or less to ground.
- Add multiple **ground rods**, by stacking vertically if the grounding system measures more than 25 ohms to ground.
- Ground rods should never be placed closer than 6 feet horizontally.



Conductor Types & Ampacities

Wire types:

- Type T – Dry Locations
- Type TW – Dry or Wet
- THHN – Dry, High Temperature
- **XHHW – High Moisture & Heat Resistance**
- UF – Direct Buried in Soil or Concrete

Wire Gauges Size & Wire Ampacity Table

Wire Gauges Size & Wire Ampacity Table	
 <p>3/0 Gauge</p>	<p>200 AMPS Service Entrance - From Utility Pole to Energy Meter</p>
 <p>1/0 Gauge</p>	<p>150 AMPS Service Entrance & Feeder Wire - To Panel Box</p>
 <p>3 Gauge</p>	<p>100 AMPS Service Entrance & Feeder Wire - To Panel Box</p>
 <p>6 Gauge</p>	<p>55 AMPS Feeder & Large Appliance Wire</p> 
 <p>8 Gauge</p>	<p>40 AMPS Feeder & Large Appliance Wire</p>
 <p>10 Gauge</p>	<p>30 AMPS Appliances e.g. Dryer, Air-conditioning, Water Heater</p>
 <p>12 Gauge</p>	<p>20 AMPS Appliances like Laundry, Bathroom & Kitchen Circuits</p>
<p>14 Gauge</p>	<p>15 AMPS General Lighting, Fans & Outlet / Receptacle Circuits</p>

Electrical Conductors

- Conductors are available in solid or stranded copper
- IMSA conductors are available in #10 awg. to #16 awg. wire sizes.



Phasing tape: At least 6" inches must be covered as per NEC

Signal Conductors

Identification of traffic signal cables/conductors is important:

- Intended purpose of the cable
- Proper matching of cables/conductors while splicing
- Keeping track of the signal cables for complete wiring of the intersection
- A single wrap of color code tape is an acceptable way of identifying signal cables/conductors

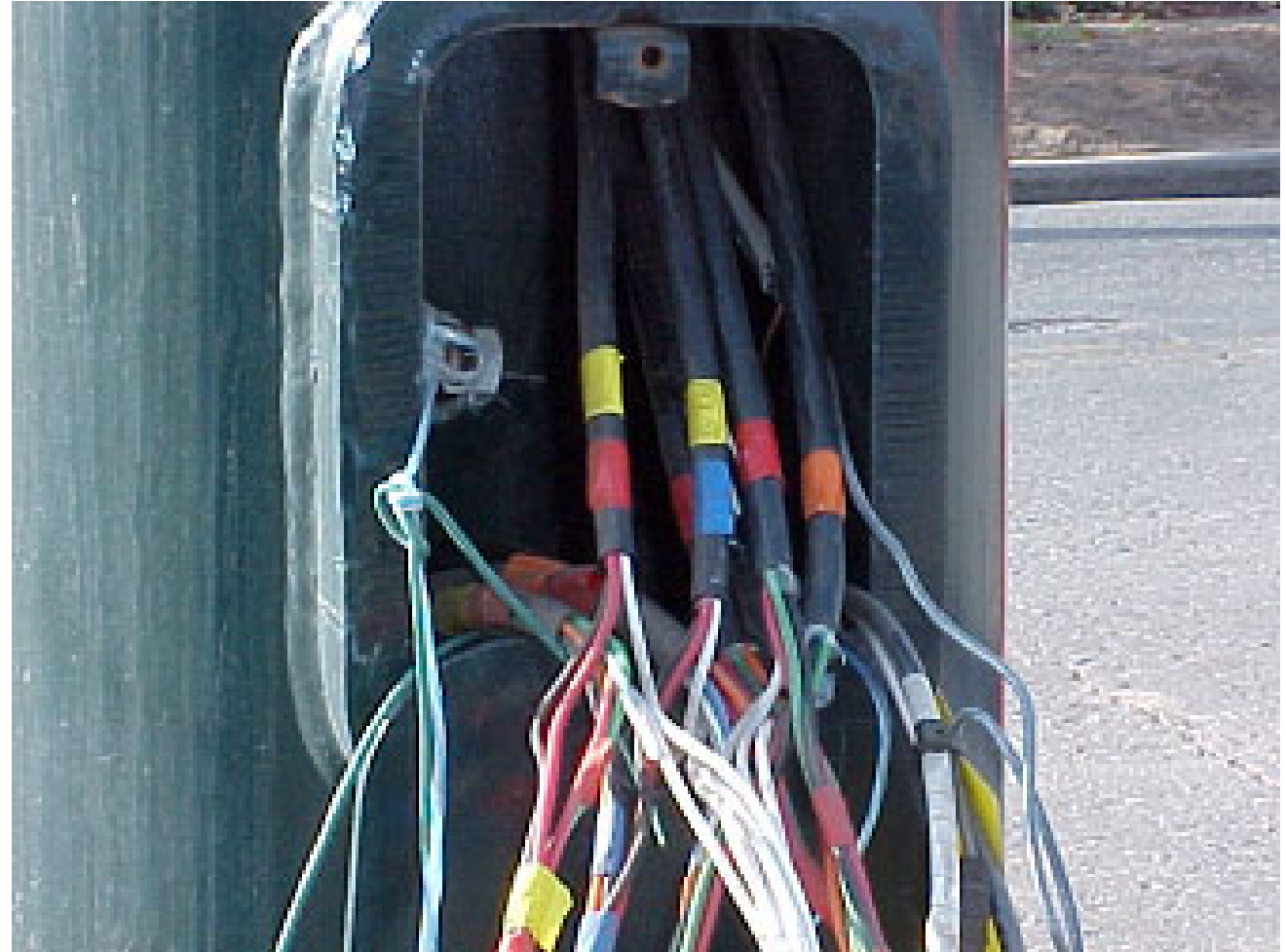

Signal Conductors

Spare signal conductors in the pole handholes, signal heads, and pull boxes should be protected with an electrical insulation.

All spare signal conductors in the cabinet should be grounded to bleed off any induced voltage.

Heat shrink caps



Heat shrink tape



Wire nuts





IMSA Cable

#12 and #14ga. wire is typically used in traffic signals.

IMSA signal cable conductors follow a specific hierarchy for the conductor colors. (see table to the right)

- numbers **in red text** are typical cable counts available from most suppliers

IMSA Hierarchy	BASE COLOR	TRACER COLOR
1	Black	n/a
2	White	n/a
3	Red	n/a
4	Green	n/a
5	Orange	n/a
6	Blue	n/a
7	White	Black
8	Red	Black
9	Green	Black
10	Orange	Black
11	Blue	Black
12	Black	White
13	Red	White
14	Green	White
15	Blue	White
16	Black	Red
17	White	Red
18	Orange	Red
19	Blue	Red
20	Red	Green
21	Orange	Green
22	Black	White & Red
23	White	Black & Red
24	Red	Black & White
25	Green	Black & White

Signal Conductors

Are all conductors installed as per plans?

Are all conductors **XHHW** insulated?

Has Conduit Been Cleaned prior to Pulling wire?

Have Wires Been Megger Tested?

Are all cables properly Tagged and or Phased correctly?

NO UNDERGROUND SPLICING

NO SPLICES IN CONDUIT

No pulling with Truck, Backhoe, Winch Truck...

Do not pull wire on surface that cars will run over wire.



Cable/Conductor Identification

Ensure that all wires are labeled according to the wiring schematics in the blueprints. You will thank yourself in the long run with good cable labeling.

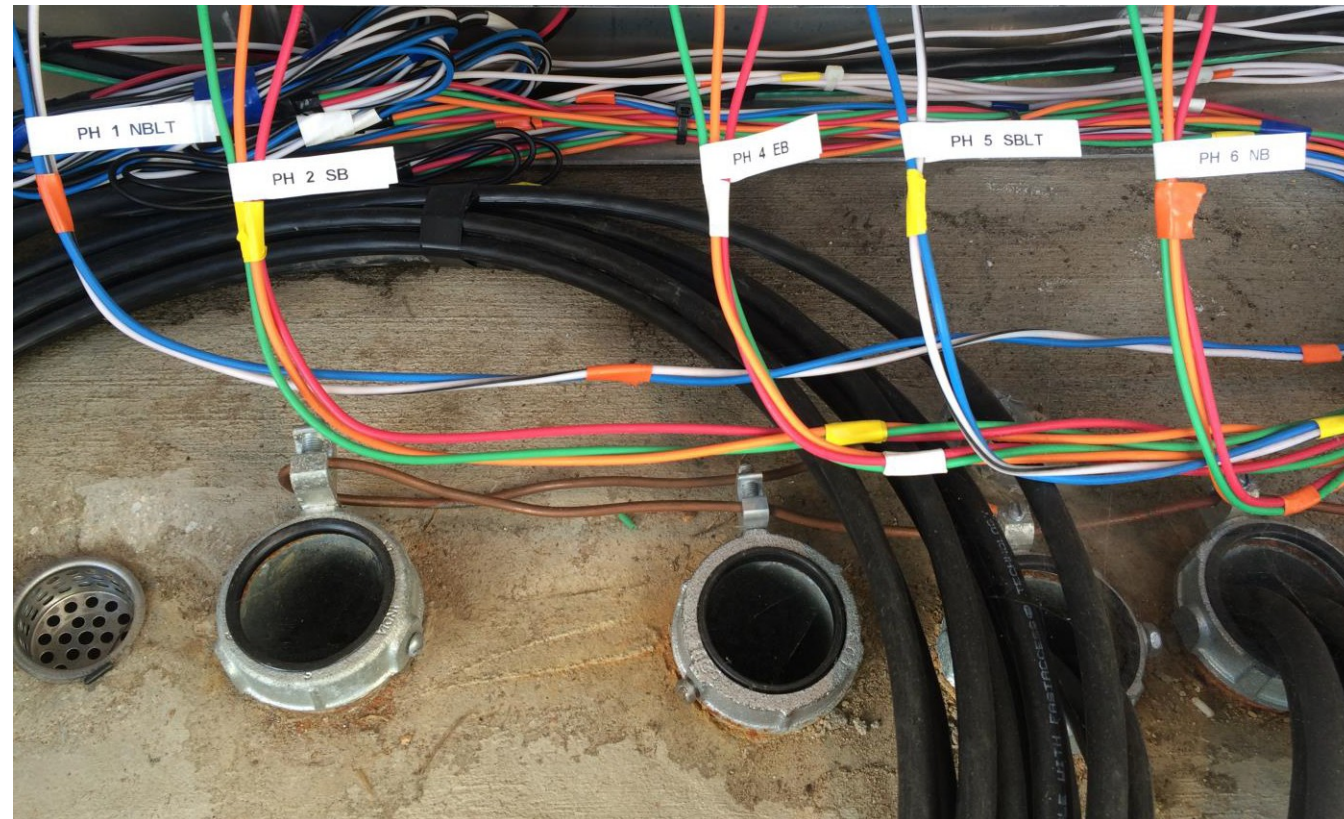

Traffic Signal Conduit



- ✓ Conduit runs are otherwise known as "raceways."
- ✓ Conduits are used to carry electrical wiring from one point to another.
- ✓ Conduits protect the enclosed wiring from mechanical/physical damages.
- ✓ Conduits also protect individuals from contacting live electrical conductors.

Prior to conduit installation, review the:

- Approved plan sheets
- Plan notes and details
- Summary of estimated quantities
- Approved change orders

Traffic Signal Conduit

Rigid metallic conduit:

- GRC – Galvanized Rigid Conduit
- IMC – Intermediate Metallic Conduit
- EMT – Electrical Metal Tubing

Exposed conduits must be RMC Metallic or PVC, schedule 80 & UV protected

Trench depth, as measured from the finish grade to the top of the conduit must meet the owner's specifications.

EMT is typically used for indoor purposes and is not approved for traffic signal projects.

All exposed support clamps, connectors and bolts must be stainless steel or galvanized.

NO NAILS or SCREWS ALLOWED!!!



Traffic Signal Conduit



Rigid metallic conduit:

RMC needs to be supported within 3 ft of conduit fittings or enclosers.

All metal conduits must be reamed to avoid wire damage.

When entering a cabinet, service or box grounding bushing must be installed to provide proper grounding.

Expansion Joints must be used where expansion is expected: bridge decks, concrete walls, conduits entering structures...

- If installed in cold weather = Expansion Joint should be retracted to allow expansion as the weather warms**
- If installed in hot weather = Expansion Joint should be expanded to allow for contraction as the weather cools**

Traffic Signal Conduit

Rigid non-metallic conduit

- PVC – Polyvinyl Chloride
- Wall thickness is based on “schedules”
 - Sch. 20, Sch 40, Sch. 80
 - The higher the schedule number, the thicker the wall

Grey Color PVC is the only conduit allowed for electrical underground installations.

All unused conduits shall be capped.

DUCT TAPE IS NOT APPROVED AS A CAP.

All PVC conduits must be reamed to avoid wire damage.

Only proper primer and solvent cement will be used to bond PVC conduit to fittings.

All Fittings will be grey PVC only. NO WATER FITTINGS.

All Ends in Pull Boxes will have Bell Ends.

PVC can only be bent by approved heater.

NO DIRECT FIRE OR EXHAUST PIPES!

Traffic Signal Conduit

- **HDPE – High-Density Polyethylene (POLY PIPE)**
 - Originally designed for pressure applications such as gas & water...
 - Wall thickness based on SDR (standard dimension ratio)
 - The higher the SDR number, the thinner the wall
 - SDR 11, 15.5, 21...
- **HDPE must be UL approved for traffic signal / electrical use**
- Fittings must be approved for HDPE installations; I.E. mechanical or Epoxy type



Traffic Signal Conduit

Raceways are only allowed a certain amount of fill percentage with conductors & cables.

According to the NEC, Chapter 9, table #1:

“Percent of Cross Section of Conduit or Tubing for Conductors and Cables”

- 1 conductor / multi-conductor cable – **53%**
- 2 conductors / multi-conductor cables – **31%**
- Over two conductors or multi-conductor cables – **40%**

** A multi-conductor cable shall be treated as a single conductor for calculating the fill percentage of a raceway.*



Foundations

Prior to work starting:

It is Mandatory for anyone doing underground construction to call 811 for locates.

- You should have the ticket numbers onsite.

All foundations must be placed in accordance with Plans. This is to ensure line of sight and signal head lane coverage is sufficient.

Poles and mast arms cannot be installed within **10ft** clearance of power lines unless prior approval/coordination is made with the local utility company.

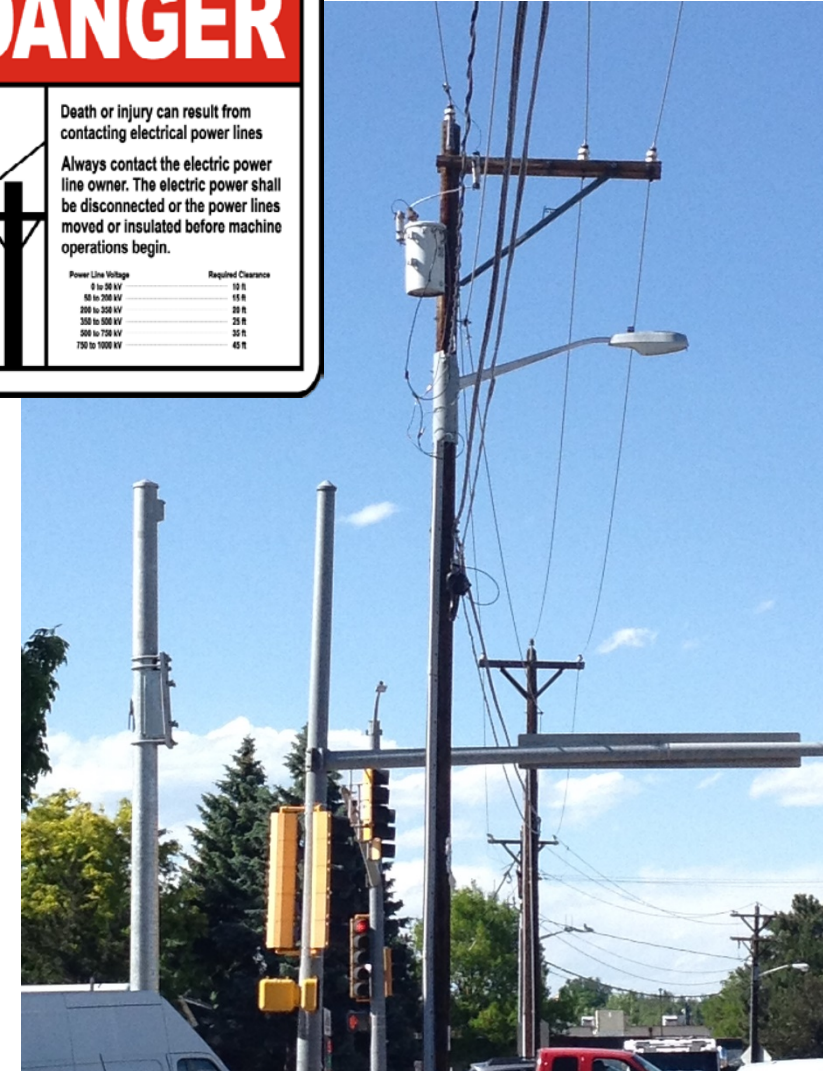
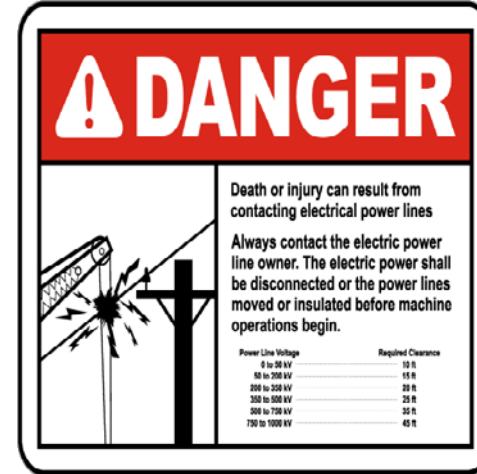

Foundations

Prior to drilling, make sure foundation is where plans call for. If not, mast arm & signal heads will not line up with road and pavement markings.

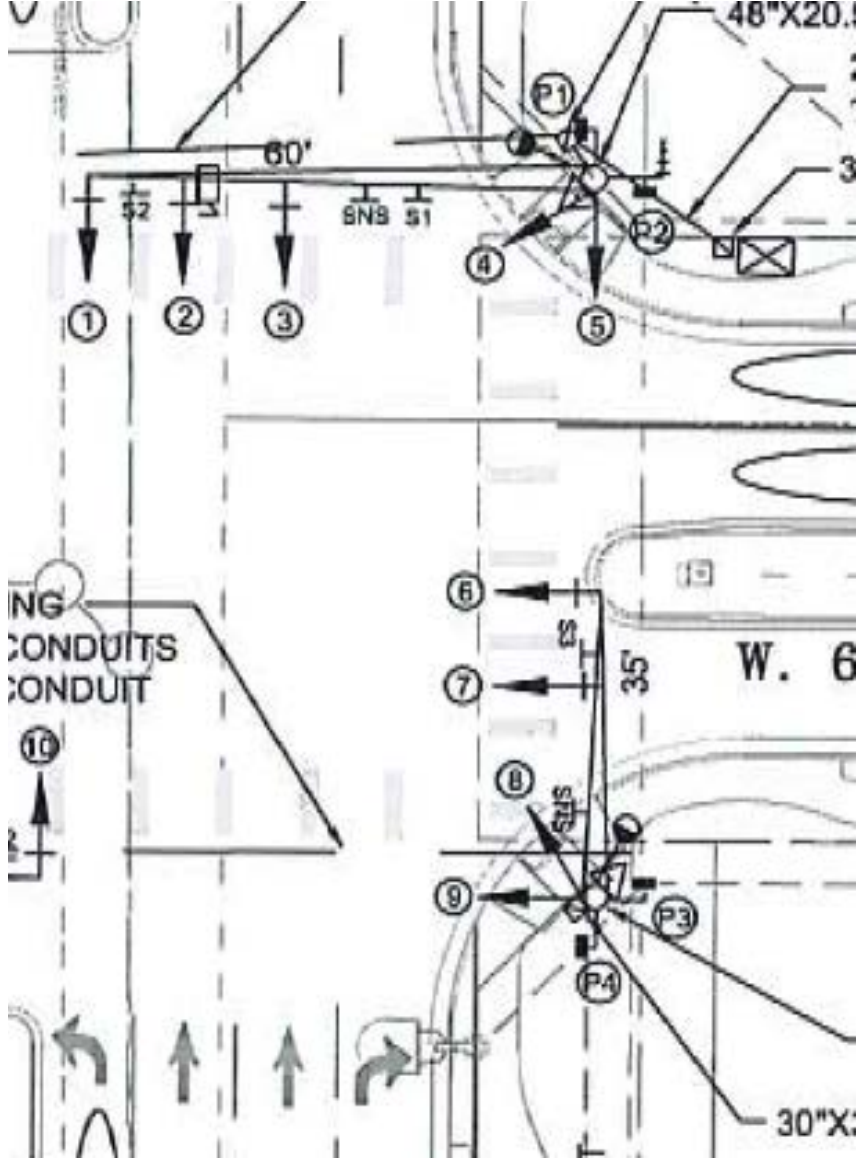

Foundations

- Cages must be centered to the hole
- Cage rebar and spirals must be built per specifications.
- Anchor bolts must be centered to the cage.
- Bolt and plates must be leveled.
- Anchor bolts must be straight when pouring concrete.
- Ground Rod must be driven all the way into the ground (do not cut ground rod).



Pedestrian Pole Foundations

Reinforcing collars are recommended for all screw-in type ped poles over 8ft

All bases must be grounded

Screw in anchors will be approved as foundation alternative as per engineer depending on soil condition.

Installation of screw in anchors
<https://www.youtube.com/watch?v=9RDaW-PKQIE>

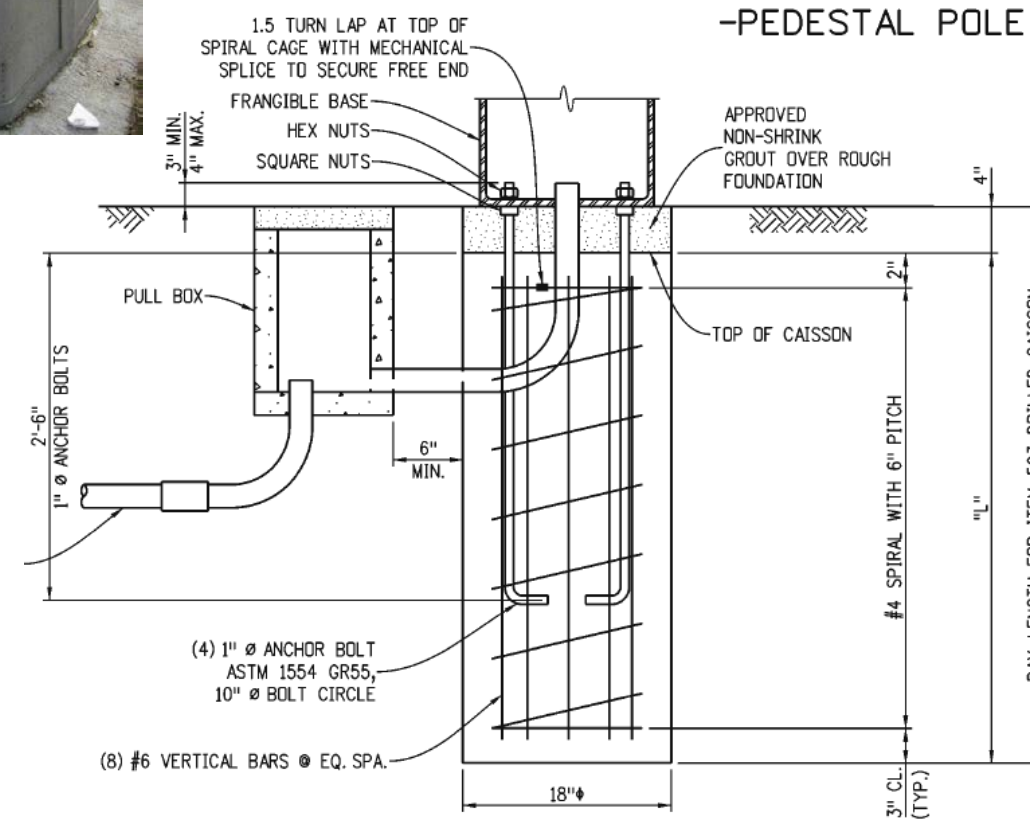

Foundation Details

- The material is approved as per submittals
- Pole foundation locations are correct as per plans
- Foundation is correct size and depth
- The correct number and size of rebar has been used
- Ground rod is in the correct place
- Concrete on foundation is flush and has proper grout
- Bolts are set to the correct height
- Correct number of conduits are per plans
- Washers are installed correct on bolts
- The base is level
- Pole is not leaning when set
- Pole is properly grounded when installed



Knowledge Check: Multiple Choice

Why should spare signal conductors be grounded in the traffic signal cabinet?

- a) To maintain a neat appearance
- b) To maintain less than 25 ohms of resistance to ground
- c) To bleed off any induced voltages
- d) To reduce the amount of power consumed

Knowledge Check: Multiple Choice

A traffic signal conduit is carrying 4, multi-conductor traffic signal cables. How much area of the conduit are you allowed to fill with these cables?

- a) 53%
- b) 40%
- c) 31%
- d) 20%

Knowledge Check: Matching Activity

The left column shows *components* that need inspection.
The right column shows items that *a technician must check*.

Match each component with the item to be checked.

A) Poles and foundations

B) Junction/pull boxes

C) Conduit

D) Construction plan

1) Presence of cracks

2) Presence of unlisted gas lines

3) Presence of water

4) Presence of crushed wires

Knowledge Check: Matching Activity

The left column shows *components* that need inspection.
The right column shows items that *a technician must check*.

Match each component with the item to be checked.

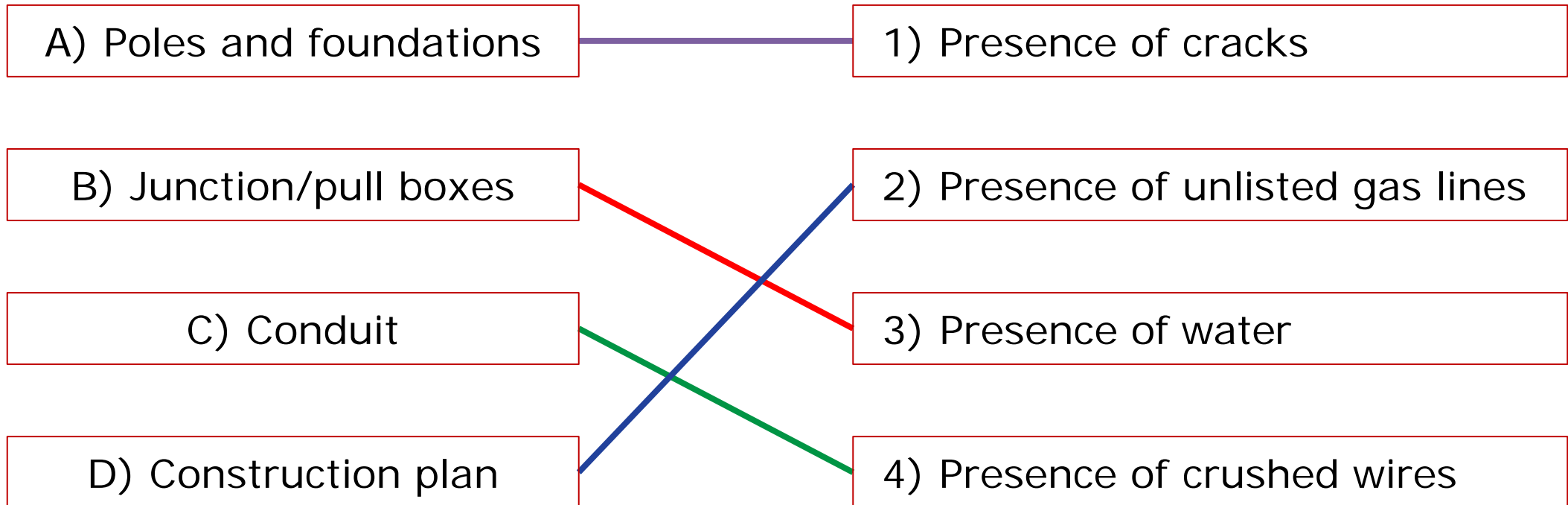

IMSA Traffic Signal Field Technician II

Session 8: Solar Powered Systems and
School Flasher Maintenance



Advancing the Future of Public Safety

Solar Powered Systems

A solar powered system is made up of:

- The **Solar Panels** – units to recharge the batteries
- The **Batteries** – the power source for the load
- The **Load** - traffic signals & cabinets, solar chargers, beacons, time clocks, cell phones, modems...

What is a solar panel?

- *A solar panel is nothing more than a large diode.*
A diode is a “PN” junction whereby:
 - The top layer of the panel is made of N-type silicon
 - The bottom layer of the panel is made of P-type silicon
 - The solar photon energy knocks the electrons out of the N-type silicon, across the junction and into the P-type silicon, where the positive side of the load is attached allowing current to flow in the circuit.



Solar Powered Systems

A solar powered system is made up of:

- The Batteries – the power source for the load

Let's talk batteries...

- Solar powered systems must use "deep cycle" batteries, sometimes referred to as 'marine' batteries.
- Deep cycle batteries are designed to continuously use up to 80% of their energy before needing to be recharged.
 - Car batteries on the other hand can only use up 50% of their energy before needing to be recharged.
 - If you draw a car battery continuously below 50% and recharge it, you'll eventually destroy the battery.

**DO NOT USE A CAR BATTERY
IN A SOLAR SYSTEM!**



Solar Powered Systems

A solar powered system is made up of:

- The Batteries – the power source for the load

Deep Cycle Batteries:

- Have a "gelled" electrolyte instead of a liquid acid/water mixture.
 - Liquid electrolytes tend to evaporate over time and may freeze closer to 32°.
- Deep cycle batteries are sealed units and maintenance free since the electrolyte does not evaporate.
 - A fully charged deep cycle battery would not freeze until the temperature got to near -76° below zero.

**DO NOT USE A CAR BATTERY
IN A SOLAR SYSTEM!**



Solar Powered Systems

A solar powered system is made up of:

- The Load; traffic signals & cabinets, beacons, time clocks, cell phones, modems...

Solar powered systems must be sized to meet the needs of the load and the requirements of the agency owner.

- How much power does the entire load consume?
- How long does the load need to run?
 - The power consumed and how long the load runs is measured in "*watt-hours*"; how many watts are consumed for how many hours the load runs?
- How many days of stored back-up power is needed?

These things add up to create the "*energy budget*" that the system must be built to run.



Solar Powered Systems

The energy budget determines:

- How much load can be powered
- How long the load can run
- How many batteries are needed to store and supply power
- How many solar panels are needed to recharge the batteries

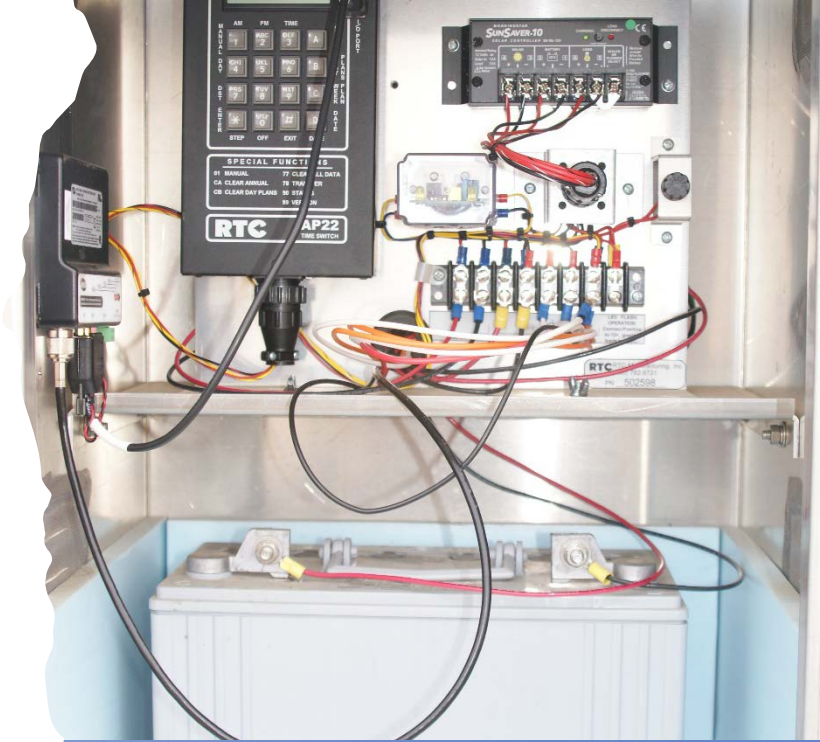

Solar Powered Systems

A solar powered beacon, for example may consume 120-Watt Hours per day (running for 3-hours per day) for 5-days, for a total of 600 W/H for the week.

- The load includes; 2 beacons, a time clock, a solar charger, and a cell modem.
- An 80-watt solar panel should put out 340 W/H per day in low sun conditions.
- After derating the solar panel and battery for real world conditions, the battery may need to have a storage capacity of 750 W/H for 5-days.

You would shop for a battery that had the storage capacity needed and the solar panel that could provide the output power to recharge the batteries.

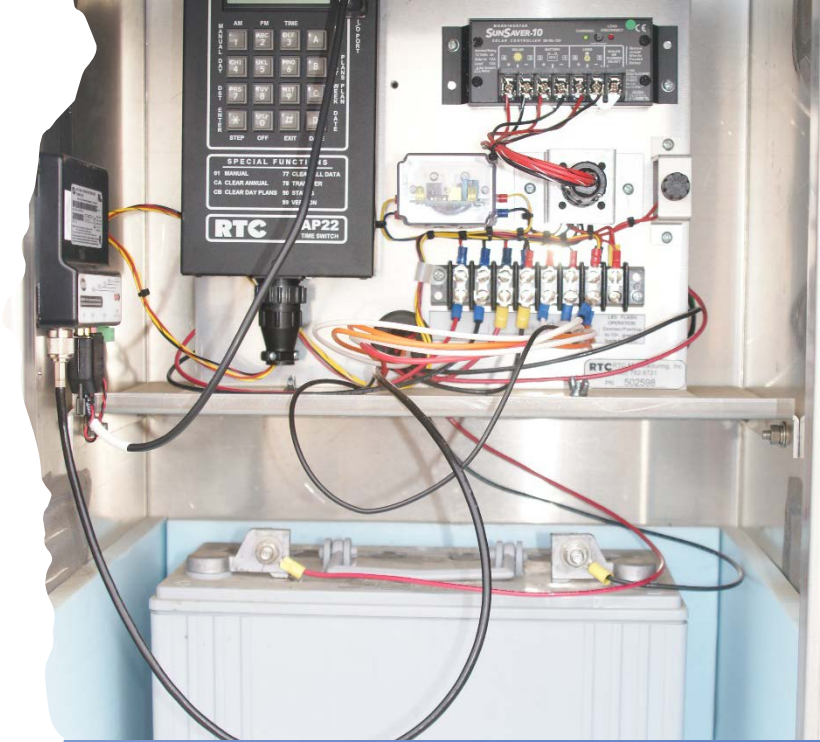

School Flasher Maintenance

Items to be Inspected, Cleaned, Adjusted or Replaced:

Beacons:

Check Single Head Alignment

Check for Cracks or Damage on Visors

Check for Cracks or Damage on Signals

Check for Cracks or Damage on Hardware

Check Gaskets on Housing

Check Terminal Connections

Visually Check All Cable

Replace LED's Out or Dim



School Flasher Maintenance

Items to be Inspected, Cleaned, Adjusted or Replaced:

Control Cabinet:

Manually test ON/OFF Operations

Verify Programming

Verify Time & Date

Lubricate Hinges & Locks

Check Terminal Connections

Vacuum Cabinet

Verify Conduits are Sealed

Cabinet Ground Reading

Check/Clean Graffiti

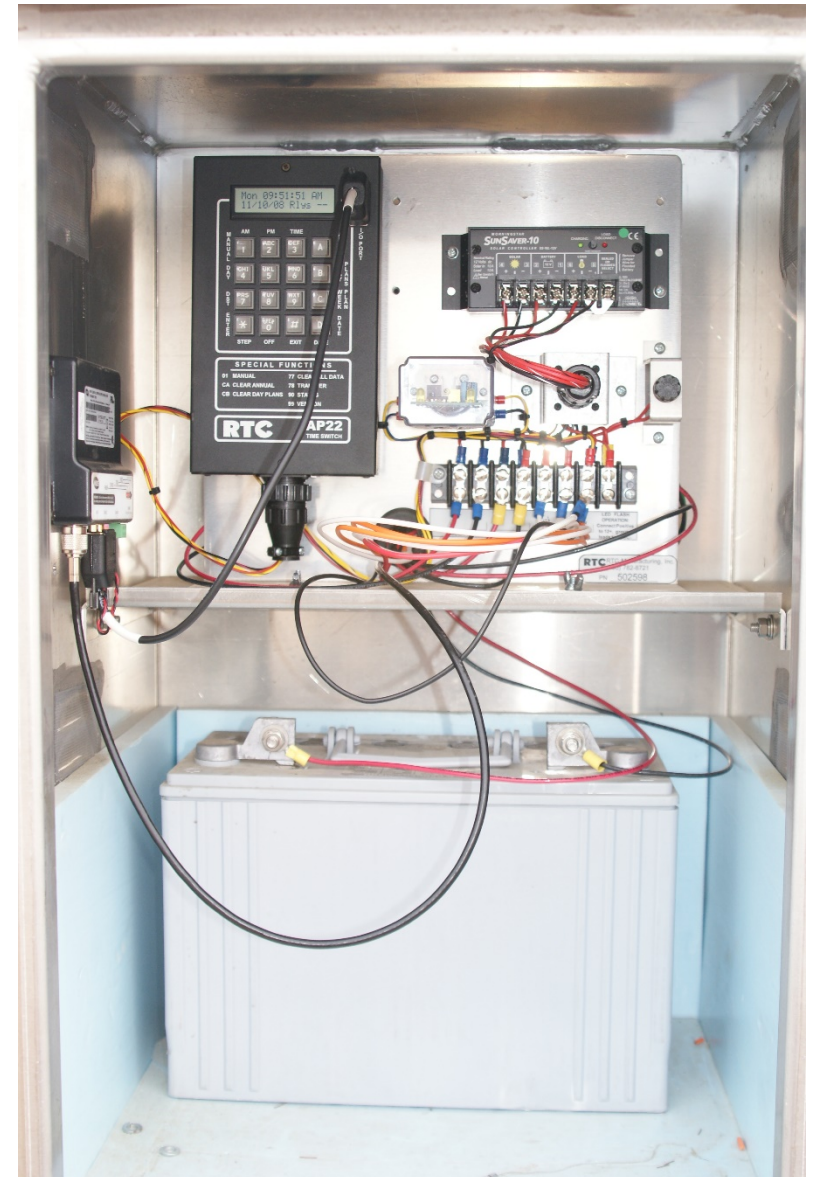

School Flasher Maintenance

Items to be Inspected, Cleaned, Adjusted or Replaced:

Batteries:

Verify incoming line voltage from solar panel

Verify the charging voltage from the solar charger to the battery

Check DC Battery Output

Load check the Batteries

Test System



School Flasher Maintenance

Items to be Inspected, Cleaned, Adjusted or Replaced:

Pole:

Verify Hand Hole Covers present

Verify Pole Cap

Inspect Foundations/Anchor Bolts

Inspect Poles Wood/Steel

Verify Collar present

Check Mounting Hardware



School Flasher Maintenance

Items to be Inspected, Cleaned, Adjusted or Replaced:

Solar Panels :

Check condition

Clean the solar panel

Verify solar panel wattage

Check for solar obstruction on panel

Check connections/terminals on Panel

Check mounting hardware



School Flasher Maintenance

Items to be Inspected, Cleaned, Adjusted or Replaced:

Signs: *In some cases when attached to a flasher, this sign may be your responsibility.*

Verify S5-1 (Diamond grade Fluorescent Yellow green)

Verify R2-1/S5-2A (Speed limit w/end school zone)

Check the mounting hardware

Check bolts for tightness



School Flasher Maintenance

Items to be Inspected, Cleaned, Adjusted or Replaced:

Grounding:

Inspect the pole and ensure it is bonded to the ground wire in the foundation.

If the pole is not grounded, install a ground wire.

Test Grounding for 25 ohm and less

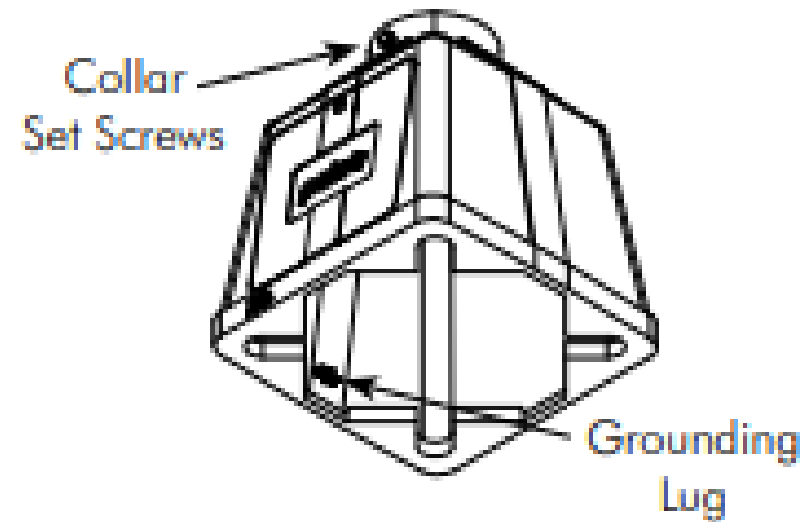

Knowledge Check: Multiple Choice

Solar panels operate on the principle of:

- a) induction
- b) A battery
- c) A diode
- d) Magnetism

Knowledge Check: Multiple Choice

What type of battery should you use for a solar ped beacon?

- a) An alkaline battery
- b) A lead acid cell battery
- c) A lithium-ion battery
- d) A gel cell battery

Knowledge Check: Multiple Choice

A solar energy budget must include:

- a) The storage size of the battery and size of the solar panel.
- b) The beacons, time clock and the solar charger.
- c) The beacons, the current in the circuit, and the circuit breaker.
- d) The available output power of the battery and the solar panel.

Knowledge Check: Multiple Choice

What should be done during an annual maintenance inspection to check the battery?

- a) Clean the battery
- b) Measure the voltage in the battery
- c) Load check the battery
- d) Replace the fluid in the battery

IMSA Traffic Signal Field Technician II

Session 9: Troubleshooting Tools / Equipment



Advancing the Future of Public Safety

Troubleshooting Tools/Equipment

- Multimeter, Megohmmeter, & LCR Meter Testing
- Conflict Monitor Tester
- Cabinet Tester
- Bus Interface Unit (BIU) Tester
- Load Switch/Switch Pack Tester
- Ground Resistance Tester
- OTDR
- Portable TV monitor
- Laptop Computer



Troubleshooting Tools/Equipment

Multimeter



A multimeter is a useful tool for basic sanity checks and troubleshooting. When using a multimeter for troubleshooting, you can measure the following:

- AC and DC Supply voltages
- Fuse and wire continuity
- Transformer primary and secondary voltages
- Diode and Transistor lead voltages
- Integrated Circuit supply pin voltages
- Component resistance

To use a multimeter, you need to turn it on, select the mode you want to use, connect the multimeter to the circuit you want to test, touch the other end of the lead to the point you want to test, and read the display on the multimeter.

Megohmmeter



Or 'Megger' for short, is a useful tool to check the integrity of the insulation on a conductor.

The first thing you need to do while using a megger is to **isolate** the conductor being tested. **NEVER** meg a conductor that is **connected** in a circuit with any equipment attached.

When using a megger, connect the megger to the conductor you want to test.

- Connect one lead to the conductor and the other lead to ground.
- Turn on the megger and select the lowest voltage possible. You can always increase the voltage if you do not get the proper readings.
- A reading of "**infinity**" indicates good conductor insulation.
- A reading of "**zero**" indicates a direct short to ground through the insulation.
- A reading of some megohm value **in between zero and infinity** indicates a compromised conductor insulation

Troubleshooting Tools/Equipment

LCR Meter



An LCR meter is a useful tool for checking and troubleshooting loops. To use an LCR for troubleshooting, you can measure the following:

- Inductance – “L” for inductance
- Capacitance – “C” for capacitance
- Resistance – “R” for resistance
- Continuity & possibly a diode tester

To use an LCR meter for testing loops, turn on the meter and select the mode (inductance) and range you want to use; “microhenries” (μh) for loops. Connect the meter across both ends of the loop and read the display on the meter.

- A zero reading will indicate an open loop.
- A numeric reading will indicate the actual inductance of the loop;
No guessing.
- If you’re checking capacitors, remember to discharge the voltage **BEFORE** you test the component.

Conflict Monitor Tester

Most monitor manufacturers recommend that the conflict monitor / MMU's be tested 'at least' annually to ensure compliance.

This can be done with a computerized conflict monitor tester. This is accomplished by removing the intersection's monitor and running a complete test with the conflict monitor tester unit, both with and without the card from the cabinet.

However, it is important to note that testing frequency may vary depending on the state or local agency requirements.

Recalibration is also a necessary process of a conflict monitor tester and recommended annually. Local agencies may also dictate recalibration standards.



Athens Technical Specialists, Inc.

Cabinet Test Displays

are a simple and effective tool for displaying and testing the state of traffic signals in the field or test environments.

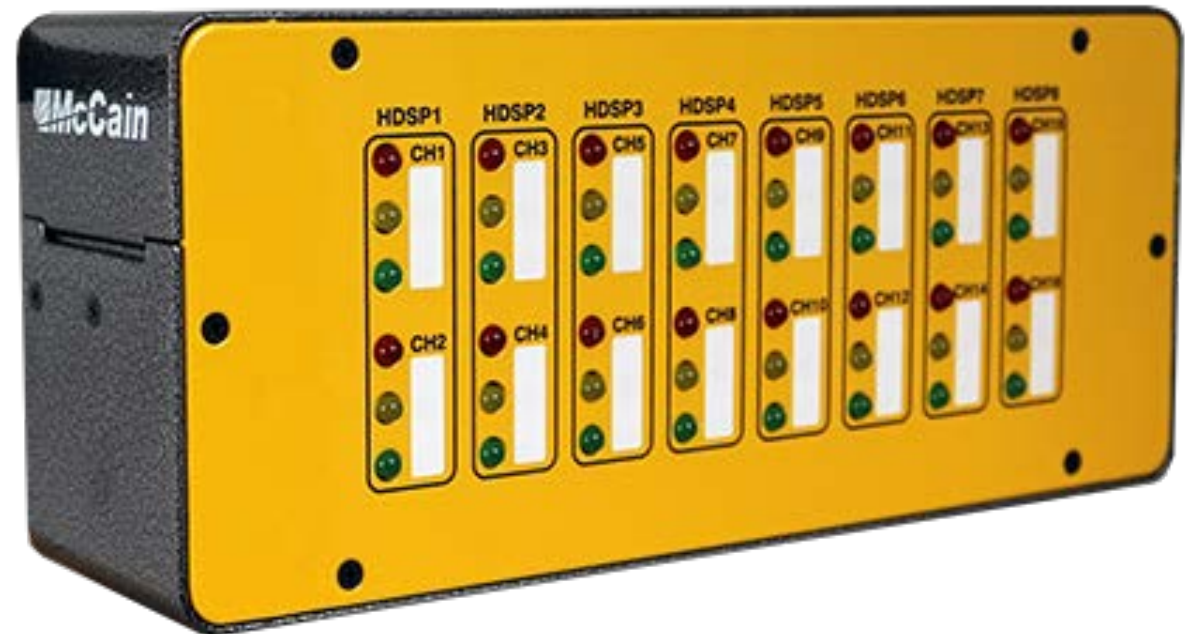

<https://www.mccain-inc.com/products/specialty/testers/cabinet-test-display>

Troubleshooting Tools/Equipment

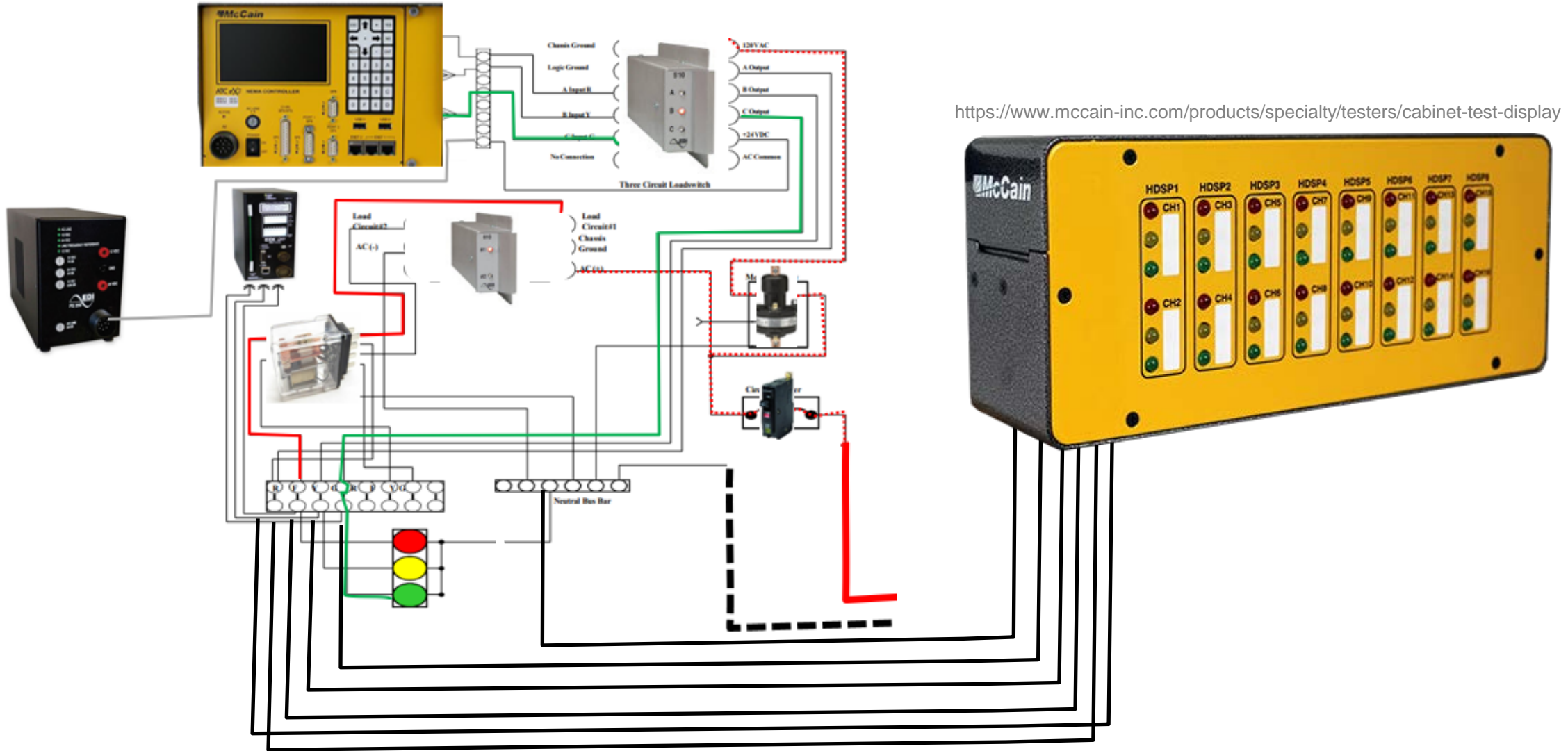

Bus Interface Unit (BIU) Tester



Athens Technical Specialists, Inc.

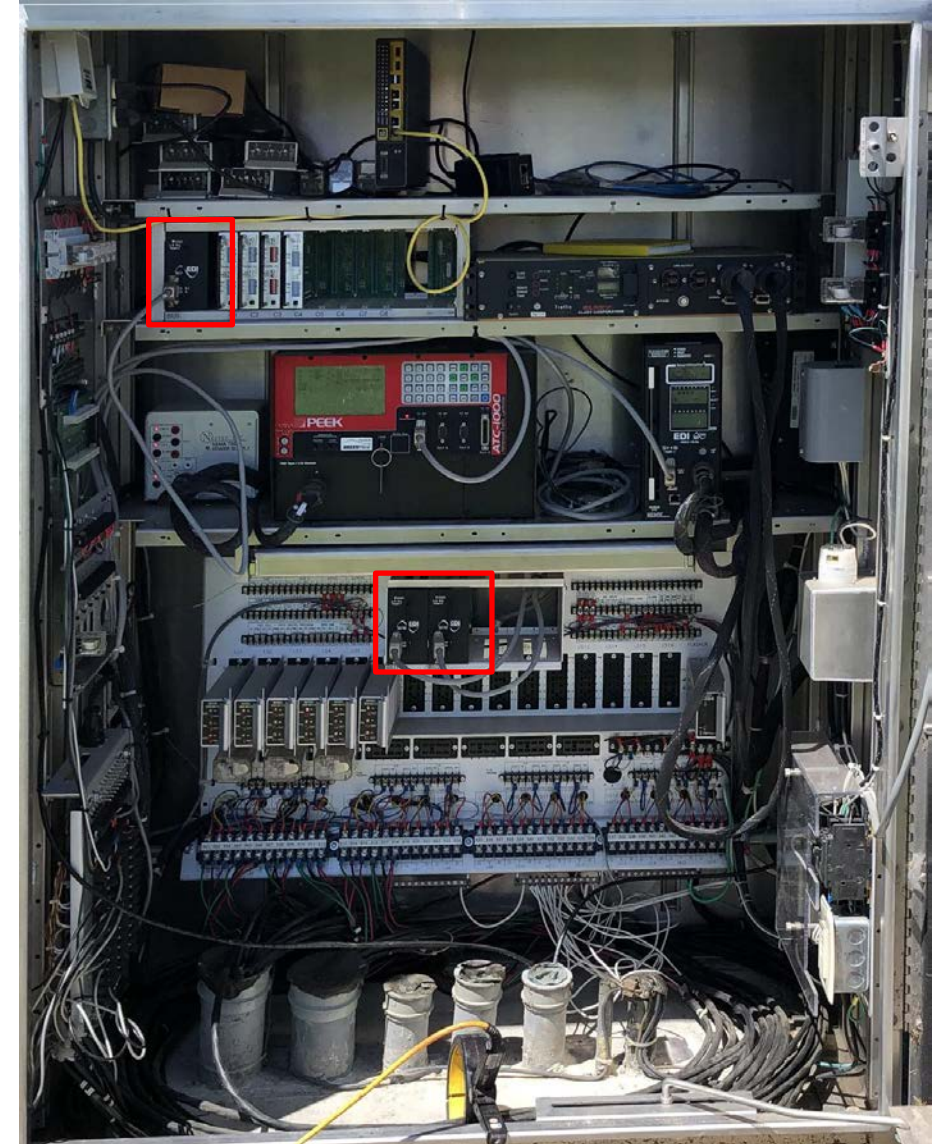

Load Switch/Switch Pack Tester



Athens Technical Specialists, Inc.

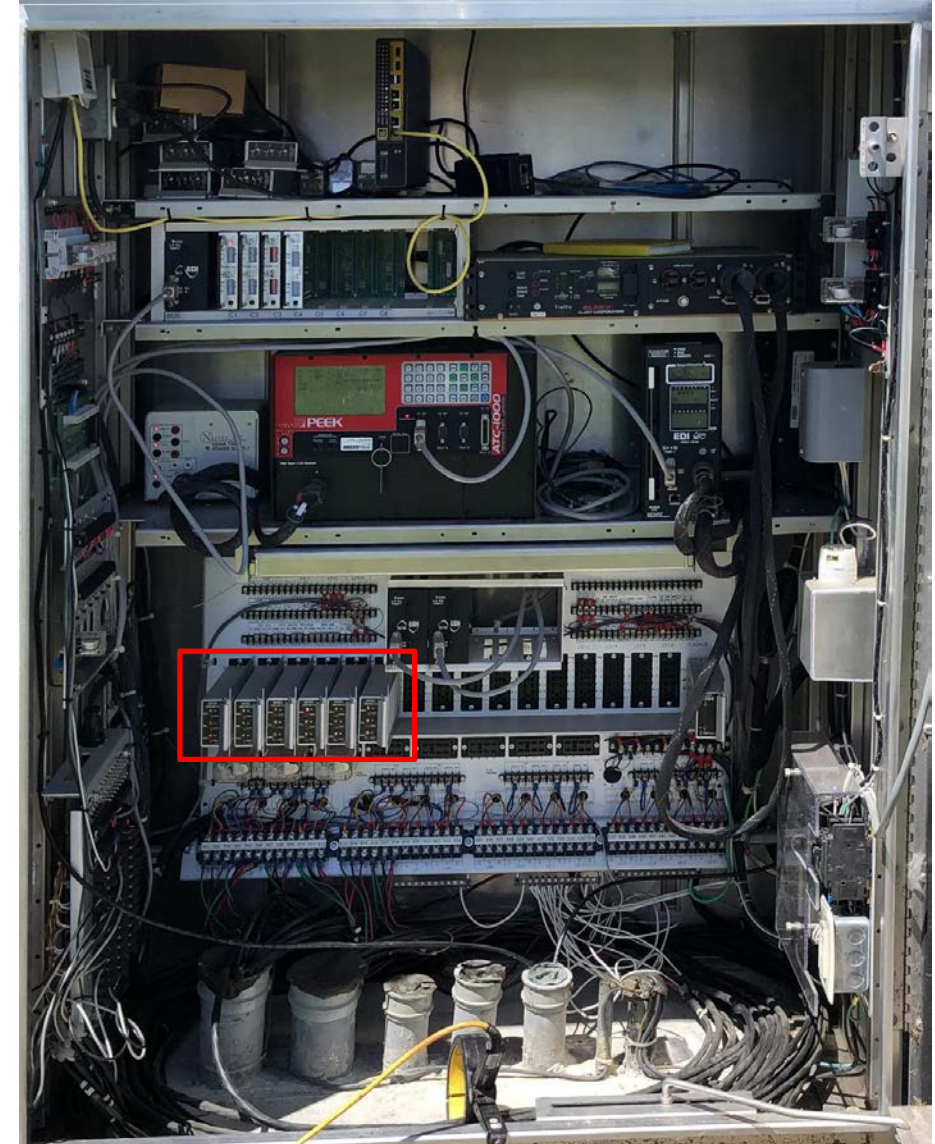

Ground Resistance Tester

The Ground Resistance Tester clamps around the grounding electrode or conductor and measures the resistance to the ground. By performing measurements on intact ground systems, the tester also verifies the quality of the grounding connections and bonds. Resistance and continuity of grounding loops are also tested.

All traffic devices/equipment that is grounded shall read **25 ohms or less** to ground.



Athens Technical
Specialists, Inc.

OTDR

An **Optical Time-Domain Reflectometer (OTDR)** is a device used in fiber optic work to detect anomalies in the fiber that may affect the data transmission and reception.

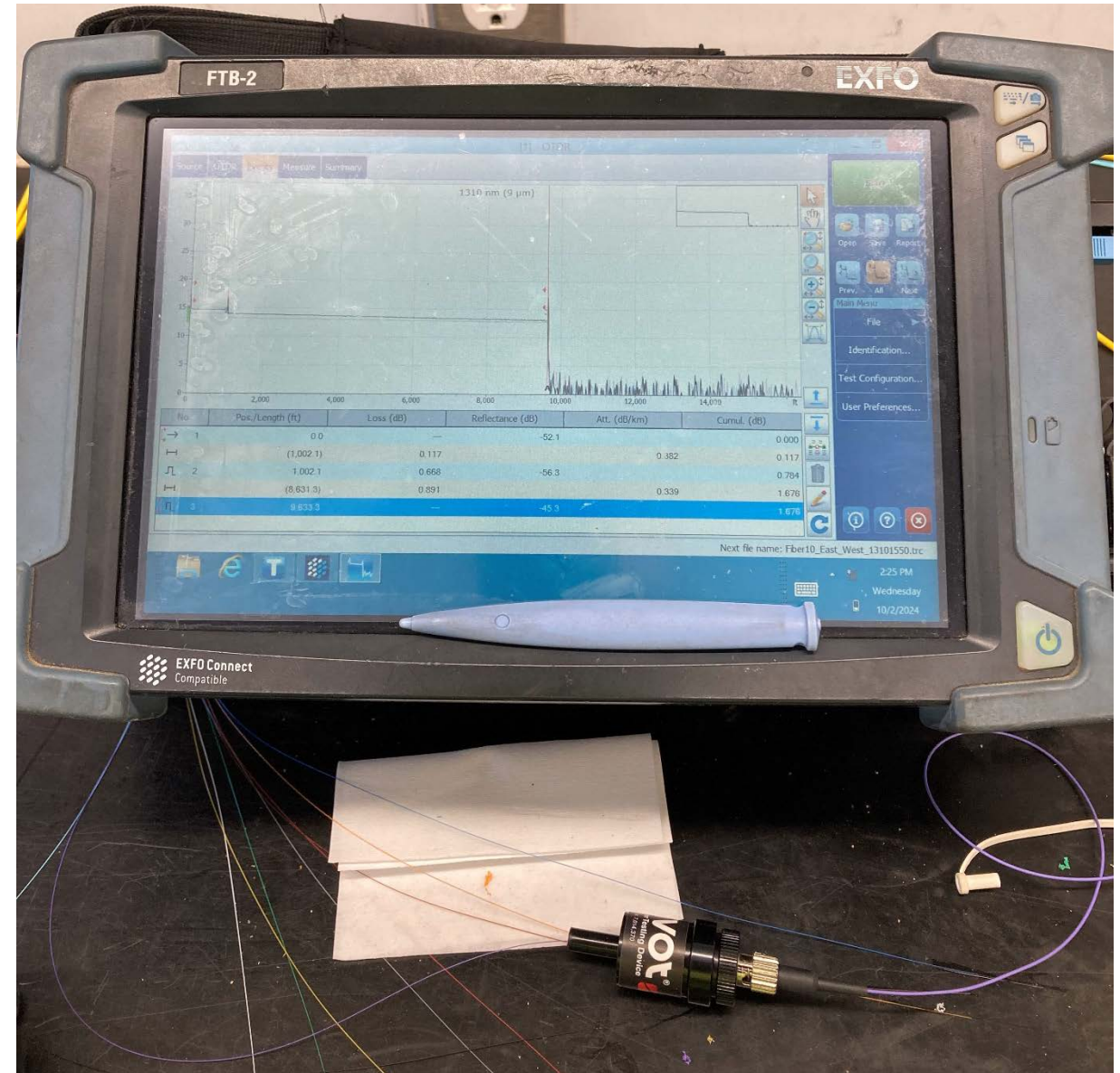

Troubleshooting Tools/Equipment

Portable TV Monitor

Portable monitors may be used to view real time video detection, and in some cases, they may be needed to properly set up video detection devices.



Laptop Computer

Laptop computers are becoming even more necessary due to specialized software in traffic signal controllers, conflict monitor / MMU's / CMUs, and detection equipment.

Common uses include:

- Controller configuration & timing
- Conflict monitor, MMU, & CMU programming
- Vehicle & pedestrian detection set up

Laptops also serve as vital troubleshooting tools. The laptop often integrates with the specialized software to collect data and provide troubleshooting information.

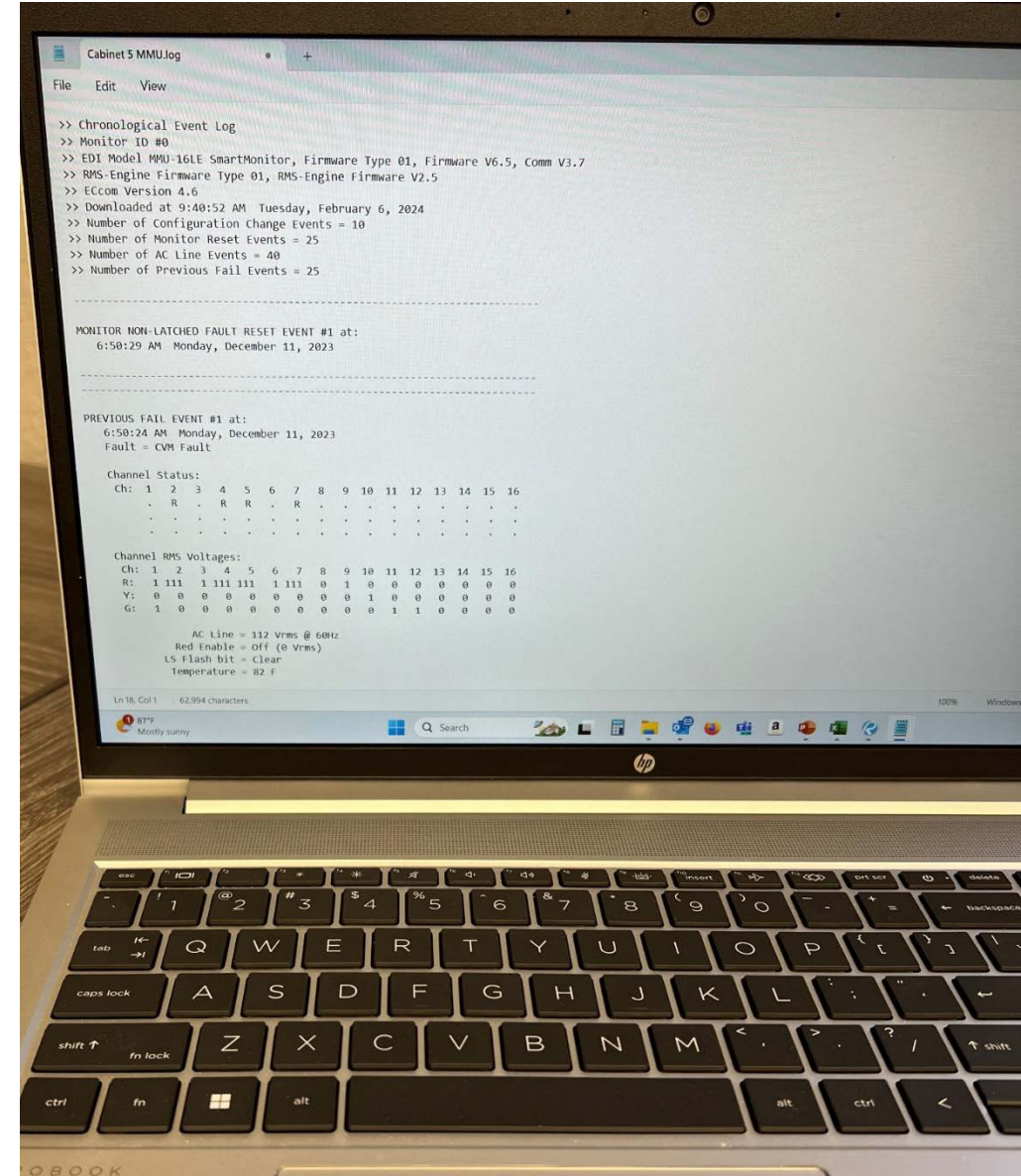

Knowledge Check: Multiple Choice

What is the best device for checking the integrity of a fuse?

- a) A Megger (Megohmmeter)
- b) A BIU Tester
- c) A Multimeter
- d) An OTDR

Knowledge Check: Multiple Choice

Should a conflict monitor test be performed with a card or without the card from the cabinet?

- a) Without a card.
- b) Both. The conflict monitor should be tested with and without the card. The card validates all jumpers are working.
- c) With the card only.

Knowledge Check: Multiple Choice

Conflict monitors / MMU's should be tested _____ to ensure compliance.

- a) Monthly
- b) Quarterly
- c) Semi-annually
- d) At least Annually

Knowledge Check: Multiple Choice

The inductance of a loop can best be tested by using _____.

- a) A BIU tester
- b) An LCR meter
- c) A Ground Resistance Tester
- d) A Megger (Megohmmeter)

Knowledge Check: Multiple Choice

When should you use a Megohmmeter or Megger?

- a) to check the resistance of a wire in a circuit
- b) to check a wire NOT connected to a circuit, for resistance or insulation breakdown
- c) to check capacitance reading
- d) to check inductance

Knowledge Check: Multiple Choice

Cabinet test displays are best used for showing and testing the _____.

- a) state of the conflict monitor/ MMU
- b) state of the flasher and the flash transfer relays
- c) state of the traffic signal
- d) state of the detection devices

IMSA Traffic Signal Field Technician II

Session 10: Traffic Signal Emergency Response



Advancing the Future of Public Safety

Remember to set up Proper Traffic Control

Set up a safe and effective work zone.
Remember to consider:

- Traffic conditions
- Pedestrian conditions
- Roadway conditions
- Weather conditions

Provide proper traffic control set up procedures along with all related safety measure requirements necessary to reduce risks associated with work on or near roadways.



Traffic Signal Maintenance & Response



- **Observe intersection**



- Isolate problem to the Field or the Cabinet



- Determine the fault that is causing the problem



- Test to isolate area causing the problem



- Correct the problem



- Verify Functionality



- Documenting / Maintenance Log



Upon arrival: Observe Intersection

Observe the area for the following:

- Visible signal damage
- Vehicle accidents
- Utility damage/issues
- Hazardous concerns/issues
- Railroad present
- Construction in the area
- Weather conditions

Anything that might be related to the problem at hand.



Observation

Is there any **physical damage** to the traffic signal equipment?

- Poles, signal heads, detection equipment, cabinet...
- Utility damage:
 - Poles, overhead wiring, transformers, switch cabinets, service pedestals...
- Emergency vehicles or railroad in the area

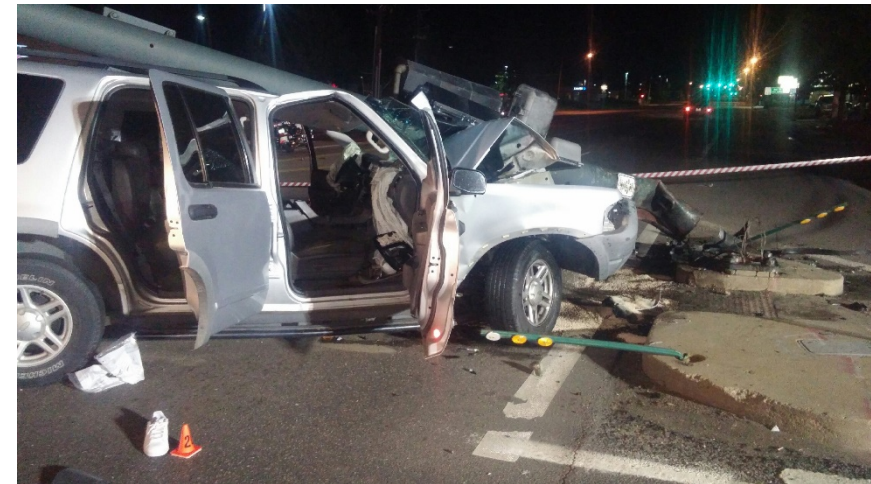

Is there any **physical damage** to the traffic signal equipment?

- Disturbed ground in the area:
 - Excavations, directional boring, paving...
- Weather conditions:
 - Lightning, hail, rain, snow, ice, wind...
- Is the signal in **flash mode**?
 - Not cycling? All Out?



<https://www.chron.com/houston/article/Remembering-Houston-s-Memorial-Day-floods-7944644.php>



Isolate the Problem to the Field or the Cabinet



- Observe intersection



- **Isolate problem to the Field or the Cabinet**



- Determine the fault that is causing the problem



- Test to isolate area causing the problem



- Correct the problem



- Verify Functionality



- Documenting / Maintenance Log



Isolate the Problem to the Field or the Cabinet

Based on your observations:

- Do you have a field problem OR
- Do you have a cabinet problem?

KEEP IT SIMPLE

Field Problem:

- Investigate the problem
- Can you do anything to solve the problem?
- Is it your problem to solve?
 - Local utility issue, perhaps not
- Do you need some help?
 - Traffic signal crew, manufacturer support, local law enforcement, etc.



Field Issues

- Wiring/termination point issues in signal heads or poles
- Pole/hardware damaged
- Pull box collapsed / missing lid
- Conduit broken or crushed
- Wire / splices damaged
- Damage due to animals



Isolate the Problem to the Field or the Cabinet

Based on your observations:

- Do you have a field problem OR
- Do you have a cabinet problem?

KEEP IT SIMPLE

Cabinet Problem:

- Open the cabinet; *IF* you have one to open
- **DON'T TOUCH ANYTHING!!**
- **Write down** the information from the controller and the monitor
- **Write down** any other information from the detectors, telemetry, preemption, power...



Cabinet Issues

- Door switches
- Components and connections
- Detection devices
- Cabinet or Field Wiring
- Improper line voltage
- Controllers
- Conflict Monitors / MMU's
- Preemption
- Telemetry



Problems in the Cabinet

Keep it simple and look at the easy stuff:

- Use your senses
 - Look, listen, & smell
- Check the door switches
- Check the circuit breakers
- Check fuses
- Check indicator lights
- Check harness connections
- Check the maintenance log for:
 - Historical information
 - Previous maintenance / repairs
 - Anything related to current issues



Isolate the Problem to the Field or the Cabinet

Review the MMU Logs

>> AC Line Event Log
 >> Monitor ID #0
 >> EDI Model 2010ECL, Firmware Type 01,
 Firmware V5.3, Comm V3.7
 >> RMS-Engine Firmware Type 00, RMS-Engine
 Firmware V0.0
 >> ECom Version 4.3
 >> Downloaded at 5:57:10 PM Monday, June 26,
 2023
 >> Number of events = 40

 AC EVENT #1 at:
 5:45:42 PM Friday, June 23, 2023
 Restore AC and WDT
 AC Line Voltage = 114 Vrms @ 60 Hz

 AC EVENT #2 at:
 5:45:41 PM Friday, June 23, 2023
 Brownout AC and WDT
 AC Line Voltage = 31 Vrms @ 60 Hz

 AC EVENT #3 at:
 7:38:34 PM Wednesday, June 21, 2023
 Restore AC and WDT
 AC Line Voltage = 115 Vrms @ 59 Hz

 AC EVENT #4 at:
 7:38:33 PM Wednesday, June 21, 2023
 Brownout AC and WDT
 AC Line Voltage = 41 Vrms @ 59 Hz

AC EVENT #5 at:
 10:49:23 AM Saturday, July 13, 2019
 Restore AC and WDT
 AC Line Voltage = 118 Vrms @ 60 Hz

 AC EVENT #6 at:
 10:49:22 AM Saturday, July 13, 2019
 Power Down
 AC Line Voltage = 0 Vrms

 AC EVENT #7 at:
 10:49:11 AM Saturday, July 13, 2019
 AC Power Up
 AC Line Voltage = 118 Vrms @ 60 Hz

 AC EVENT #8 at:
 10:05:53 AM Saturday, July 13, 2019
 Brownout WDT
 AC Line Voltage = 0 Vrms

 AC EVENT #9 at:
 10:05:53 AM Saturday, July 13, 2019
 Power Down
 AC Line Voltage = 0 Vrms

AC EVENT #10 at:
 10:46:43 AM Thursday, May 23, 2019
 Restore AC and WDT
 AC Line Voltage = 117 Vrms @ 60 Hz

 AC EVENT #11 at:
 10:46:42 AM Thursday, May 23, 2019
 Power Down
 AC Line Voltage = 0 Vrms

 AC EVENT #12 at:
 9:19:57 AM Thursday, May 23, 2019
 AC Power Up
 AC Line Voltage = 113 Vrms @ 60 Hz

 AC EVENT #13 at:
 8:23:20 AM Thursday, May 23, 2019
 Power Down
 AC Line Voltage = 0 Vrms



Isolate the Problem to the Field or the Cabinet

```
>> Previous Fail Event Log
>> Monitor ID #0
>> EDI Model 2010ECL, Firmware Type 01, Firmware V4.5, Comm V3.5
>> RMS-Engine Firmware Type 01, RMS-Engine Firmware V1.5
>> ECom Version 4.5
>> Downloaded at 9:40:13 AM Wednesday, March 15, 2023
>> Number of events = 25
```

PREVIOUS FAIL EVENT #5 at:
 06:48:04 AM Monday, December 11, 2024
Fault = Dual Indication

Channel Status:
 Ch: 1 2 3 4 5 6 7 8 9 10 11 12 13 14 15 16

```

R R . . R R . . R R R R R R R R
. . . . . . . . . . Y . . . . .
. . . G . . . G . . . G . . . . .
  
```

Channel RMS Voltages:
 R: 0 0 0 0 0 0 0 0 0 0 0 0 0 0 0 0
 Y: 0 0 0 4 6 4 0 0 0 0 0 0 0 0 0 0
 G: 0 0 0 120 11 4 0 0 0 0 0 0 0 121 3 0

AC Line = 122 Vrms @ 60Hz
 Temperature = 67 F
 Red Enable = Off (0 Vrms)
 MC Coil (EE) = Auto (4 Vrms)
 Special Function #1 = Off (0 Vrms)
 Special Function #2 = Off (0 Vrms)
 WDT Monitor = Active

Review the MMU Logs

PREVIOUS FAIL EVENT #6 at:
 06:45:46 AM Monday, December 11, 2024
Fault = Red Fail

Channel Status:
 Ch: 1 2 3 4 5 6 7 8 9 10 11 12 13 14 15 16

```

. . R R . . R R . R . R R R R R
. . . . . . . . . . Y . Y . . . . .
. G . . . . . . . G . G . . . . .
  
```

Channel RMS Voltages:
 R: 0 0 0 0 0 0 0 0 0 0 0 0 0 0 0 0
 Y: 0 0 0 0 0 0 0 0 113 0 114 0 0 0 0 0
 G: 0 114 0 0 0 0 0 0 112 0 113 0 0 0 0 0

AC Line = 114 Vrms @ 60Hz
 Temperature = 74 F
 Red Enable = Off (0 Vrms)
 MC Coil (EE) = Auto (4 Vrms)
 Special Function #1 = Off (0 Vrms)
 Special Function #2 = Off (0 Vrms)
 WDT Monitor = Active

WDT Monitor = Active



Isolate the Problem to the Field or the Cabinet

Conflict – Voltage detected on conflicting channels for more than 450ms (NEAM) or 500ms (Caltrans). **Possible causes** - burned out lamps, field wires shorted, faulty transfer relay faulty load switches

Red Fail or Lack of Signal – No voltage detected for more than 1000ms to 1200ms on any given channel. **Possible causes** - BIU Malfunction, Faulty load switch(s), no controller output

CVM – Controller voltage monitor was not held in a low state; 0 VDC. **Possible causes** - Police panel flash ON, controller setting the signals to flash by time-of-day program, faulty controller or operating voltages

Watch Dog – The microprocessor missed a sync pulse(s) for more than 200ms (NEMA) or 1600ms (Caltrans). **Possible causes** – communications errors, bad microprocessor

24V-1 & 24V-2 – Voltage level fell below 18 VDC. **Possible causes** - Blown fuse in power supply, bad external or internal power supply, faulty 24 VDC input



Isolate the Problem to the Field or the Cabinet

Clearance Fail – The yellow clearance interval or the yellow + red clearance intervals before the next conflicting green was less than 2.7 seconds.

Possible cause - another fault, preemption calls, programming in controller

Port 1 Fail – SDLC communications was lost. (3 port one failures in a 24-hour period will result in a latched fault.)

Possible cause - bad controller, BIU malfunction, SDLC plugs / cables

PGM Card – Missing card, mis-aligned card, faulty card

Field Check – The monitor input(s) didn't match the controller output(s)

Dual Indication or Multiple – voltage detected in multiple places on a single channel for more than 450ms to 700ms.

Possible cause – shorted wiring, bad load switch, bad FTR, bad BIU, controller outputs shorted together

12 VDC – Voltage level fell below 9 VDC **Possible cause** - Blown fuse in power supply, bad external or internal power supply

DIAGNOSTIC – Conflict monitor issues; microprocessor, RAM, power supply...



Isolate the Problem to the Field or the Cabinet

Program Card – The program card is not installed, not seated properly, or not programmed

BND fail – Blinking, Noise, or Dimming – this fault could be found in older conflict monitors. It looked for flickering voltages, dirty power, or low voltages that could dim the signal indications. This fault would often cause the monitor to flash the signals for otherwise normal conditions.

Possible cause – pinwheeling load switch outputs, EMF interference, low voltage anomalies.

Recurrent pulse (RP) – a supplemental indication to the normal “Conflict”, “Red Fail”, or “Dual Indication” faults that would show if the cause was intermittent or pulsing in nature. This fault replaced the BND fault above.

Possible cause – pinwheeling or flickering load switch outputs, short term transients on the electrical service, electrical noise that could cause improper signal indications.



Isolate the Problem to the Field or the Cabinet



Everything in the cabinet can fail, which includes the monitor.

Here are some faults that can occur within a malfunction management unit:

Failure to Detect Malfunctions: The MMU/CMU may fail to detect certain faults or malfunctions within the traffic signal system. This could be due to software or hardware errors, inaccurate or faulty inputs, or programming issues, in which the monitor may not be able to accurately identify faults or take appropriate actions.

False Alarms: On the other hand, the MMU/CMU may generate false alarms, indicating malfunctions when there are none. This can be caused by incorrect threshold settings, faulty sensor inputs, or software glitches.

Isolate the Problem to the Field or the Cabinet

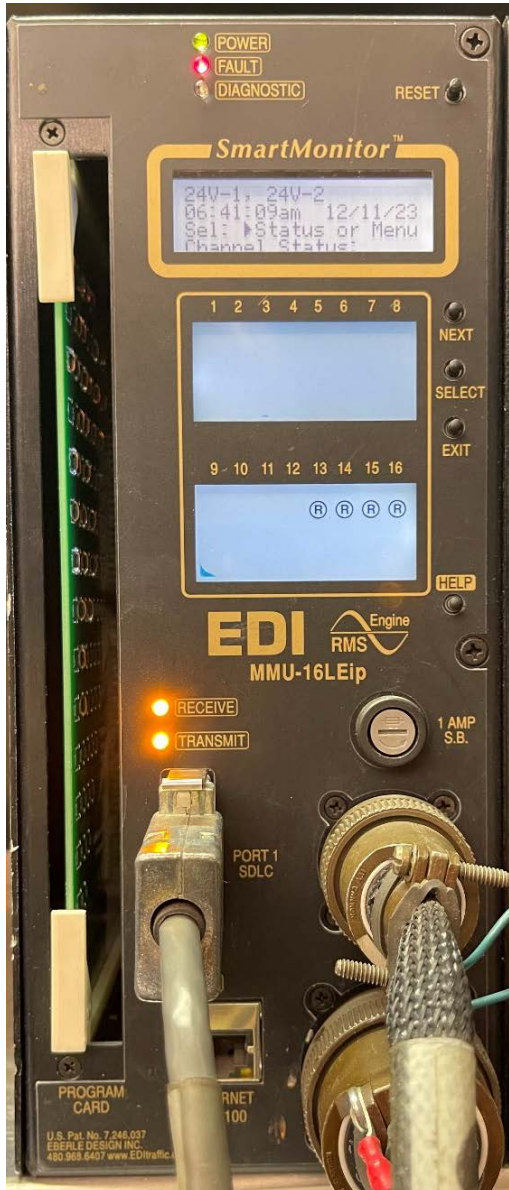

Faults that can occur within a malfunction management unit:

Communication Errors: The MMU/CMU relies on communication interfaces and protocols to receive data from various components and subsystems of the traffic signal system. Communication faults, such as connection issues, data corruption, or protocol mismatches, can result in inaccurate information or failure to detect malfunctions.

Faulty Decision-Making: The MMU/CMU uses decision-making algorithms to determine the appropriate response to detected malfunctions. Programming errors or incorrect logic can lead to improper actions, such as ineffective system shutdowns, or unnecessary alerts.

Isolate the Problem to the Field or the Cabinet

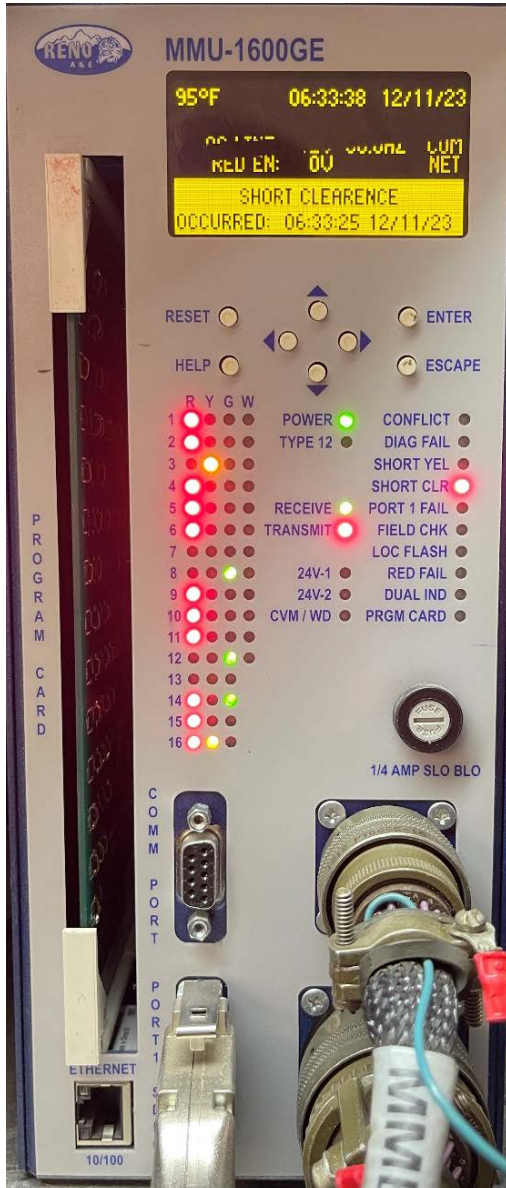

Faults that can occur within a malfunction management unit:

Inadequate Redundancy or Backup: A malfunction / conflict management unit should have sufficient redundancy or backup mechanisms to ensure system reliability. If the MMU/CMU lacks redundancy or backup solutions, it may not be able to handle its own faults or failures, leading to system-wide disruptions.

Incompatibility with System Components: The MMU/CMU must be compatible with the components and subsystems of the traffic signal system. Incompatibility issues, such as incompatible protocols or hardware interfaces, can prevent proper communication and fault detection.

Isolate the Problem to the Field or the Cabinet



Faults that can occur within a malfunction management unit:

Software or Firmware Errors: The MMU/CMU operates using software or firmware, which can be prone to bugs, coding errors, or compatibility issues. These issues can affect the performance and reliability of the unit, leading to incorrect malfunction detection or response.

Regular maintenance, testing, and software updates are crucial to mitigate these faults with a malfunction management unit.

Continuous monitoring and periodic audits can help identify and rectify any issues to ensure effective fault detection and management in the traffic signal system.

Isolate the Problem to the Field or the Cabinet



Everything in the cabinet can fail, which includes the controller.

- **Communication failures:** Modern traffic signal controllers often communicate with a central system that adjusts timings based on overall traffic conditions. Any interruption in this communication can lead to inefficient signal timings.
- **Faulty timings or settings:** Sometimes, the programmed timings or settings may not match the actual traffic requirements, causing inefficiency and confusion.
- **Signal coordination issues:** When signals along a corridor are not correctly coordinated, it can lead to stop-and-go conditions, inefficient traffic flow, and increased congestion.



Isolate the Problem to the Field or the Cabinet



<https://www.cubic.com/>



<https://www.businesswire.com/>

- **Software errors:** These could be due to programming and/or faulty software controlling the traffic signal timing and sequencing. This could cause incorrect timing sequences, such as too short green phases or simultaneous green signals in conflicting directions.
- **Malfunctions in the detector:** Traffic signal controllers often use detectors (like inductive loop detectors, video detectors, etc.) to sense the presence of vehicles and adjust signal timings. Malfunctions or faulty mapping in these detectors can cause incorrect signal changes.
- **Cycle fault:** Refers to an issue or malfunction in the timing sequence of a traffic signal's signal phases and intervals. It occurs when the traffic signal does not follow the expected and predefined cycle or pattern of green, yellow, and red phases for each direction of traffic flow.

Isolate the Problem to the Field or the Cabinet



<https://www.orangetraffic.com/>



<https://hotcore.info/babki/traffic-signal-controller.htm>

- **Hardware failures:** These include power failures, failures in the input-output card, processor faults, detector faults, etc. For example, if the power supply to the controller is interrupted, the traffic signals would not function.
- **Physical damage:** This could be due to weather conditions, vandalism, accidents, etc. For example, if lightning strikes signal equipment, it could disrupt the controller operation.
- **Lamp or LED failure:** If the lamps or LEDs in the signal heads fail, the signals won't be visible to the drivers, creating dangerous conditions.
- ***If, for ANY reason you replace the controller, it is important to verify that the correct database is programmed and functioning before you leave the intersection.***

Determine the Fault



- Observe intersection



- Isolate problem to the Field or the Cabinet



- **Determine the fault that is causing the problem**



- Test to isolate area causing the problem



- Correct the problem



- Verify Functionality



- Documenting / Maintenance Log



Determine the Fault

Divide and conquer from the field terminals:

- Remove the affected wire(s) from the field terminals
- Load the terminal(s) with a lamp & socket
- Reset the monitor
 - If the signal runs, the problem is in the field
 - If the signal doesn't run, the problem is in the cabinet



Based on the information given:
Do you have a field or a cabinet problem?



Determine the Fault

Field Problem:

- Look for damage to signal heads:
wiring, mounting hardware, housing,
lenses, LED/lamps, backplates, visors...
- Damage to span wires & hardware
- Damage to poles & mast arms:
knock downs, bent or leaning poles/mast
arms, cracks & dents, corrosion...
- Damage to underground facilities:
crushed pull boxes, pull boxes full of
water, damaged conduit, crushed, cut, or
corroded wiring / splices, power feeds...
- Review **intersection** wiring diagrams

Based on the information given:
Do you have a field or
a cabinet problem?



Determine the Fault

Cabinet Problem:

- Do you see any **loose or broken field wire** terminals?
- Is there damage to the **cabinet wiring** or wire harness?
- Is there debris, insects, or moisture in the cabinet?
- Is there a hardware failure?
load switches, FTR's, flasher(s), BIU's, power supply, monitor, controller, detection, preemption, or telemetry equipment...
- Power failure, power feed/service problem, breakers, fuses...

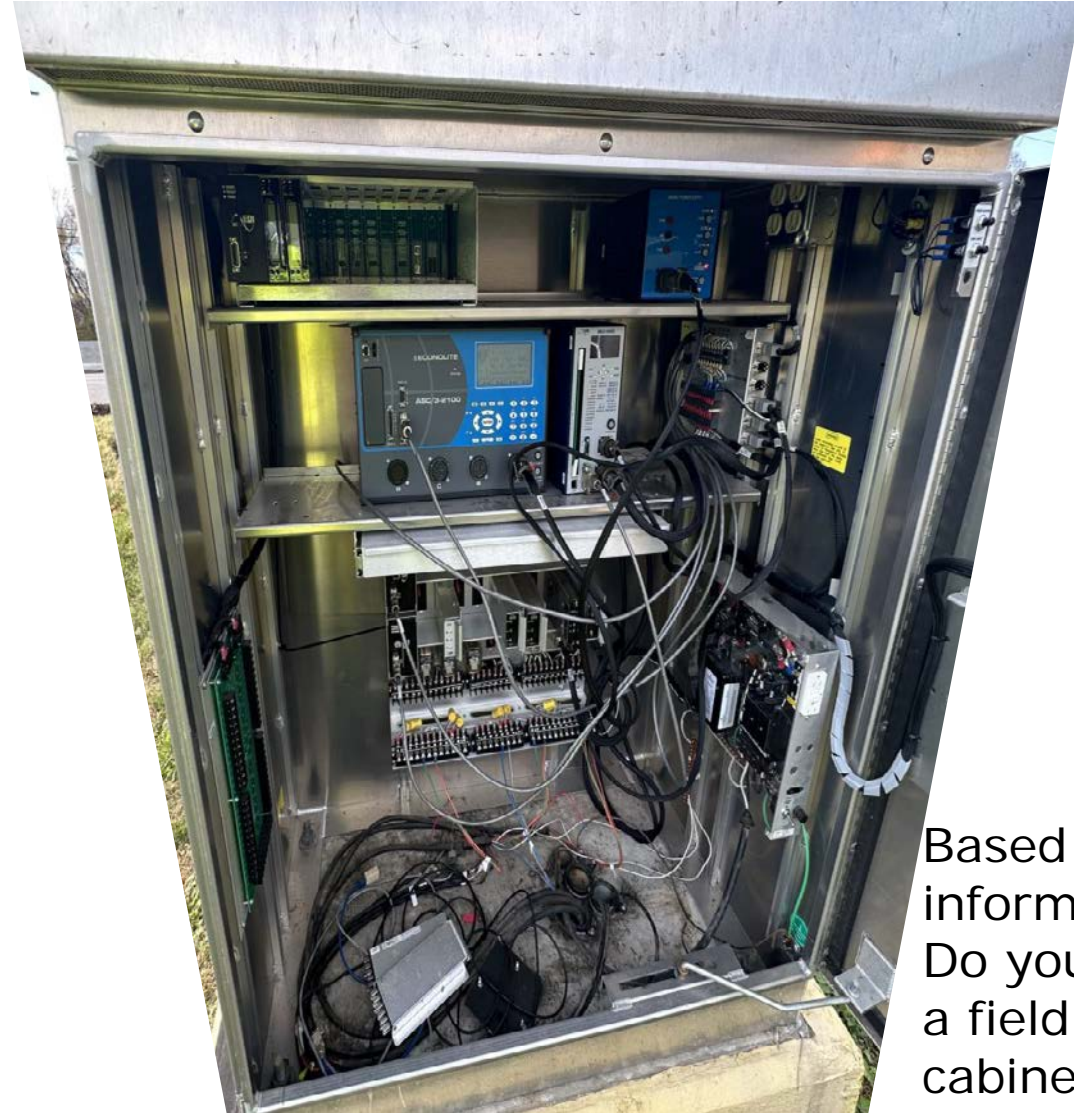

Based on the information given:
Do you have a field or a cabinet problem?

Determine the Fault

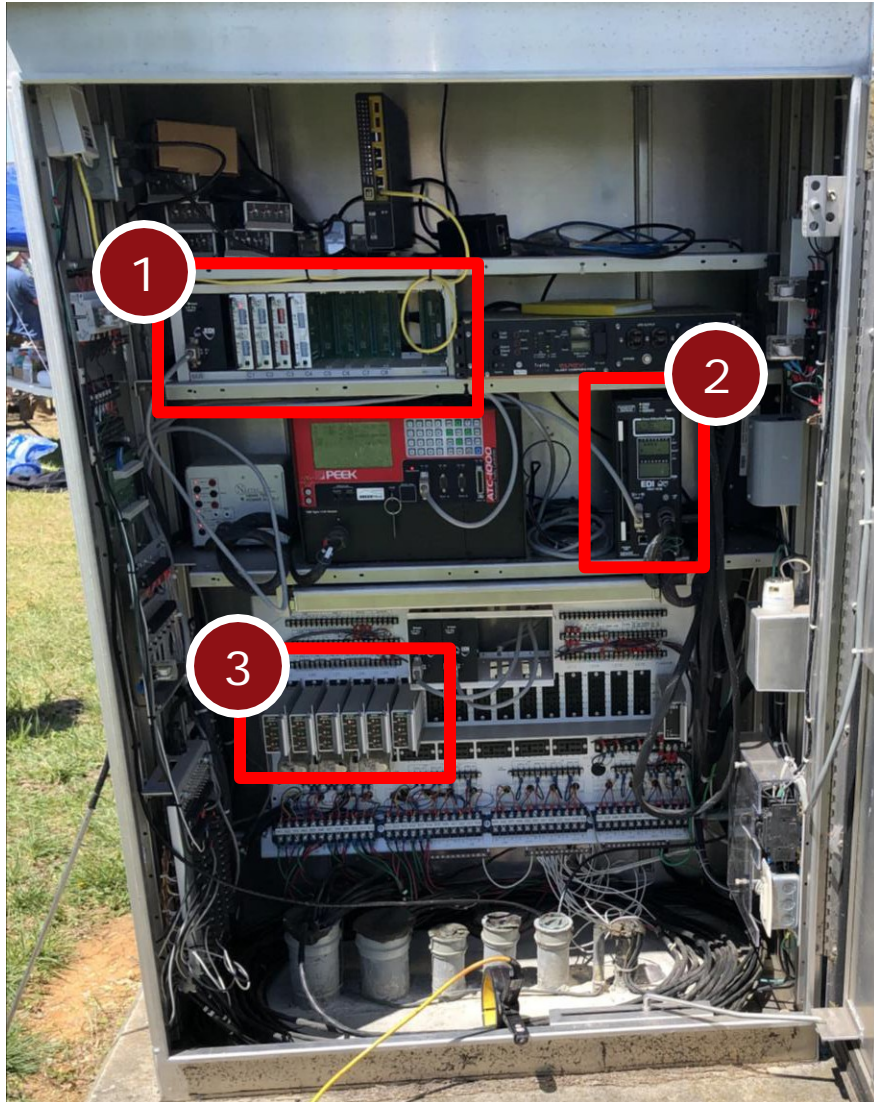

1. BIU



2. MMU/CMU



3. Load Switch



- Check for a BIU failure.
- Check for loose wiring harnesses to the cabinet equipment.
- Check for other hardware failures.

Determine the Fault

- Look, Listen & Smell for any **electrical anomalies**.
- If electrical equipment is faulty, **disconnect the power** and repair, as necessary.
- Inspect wiring.

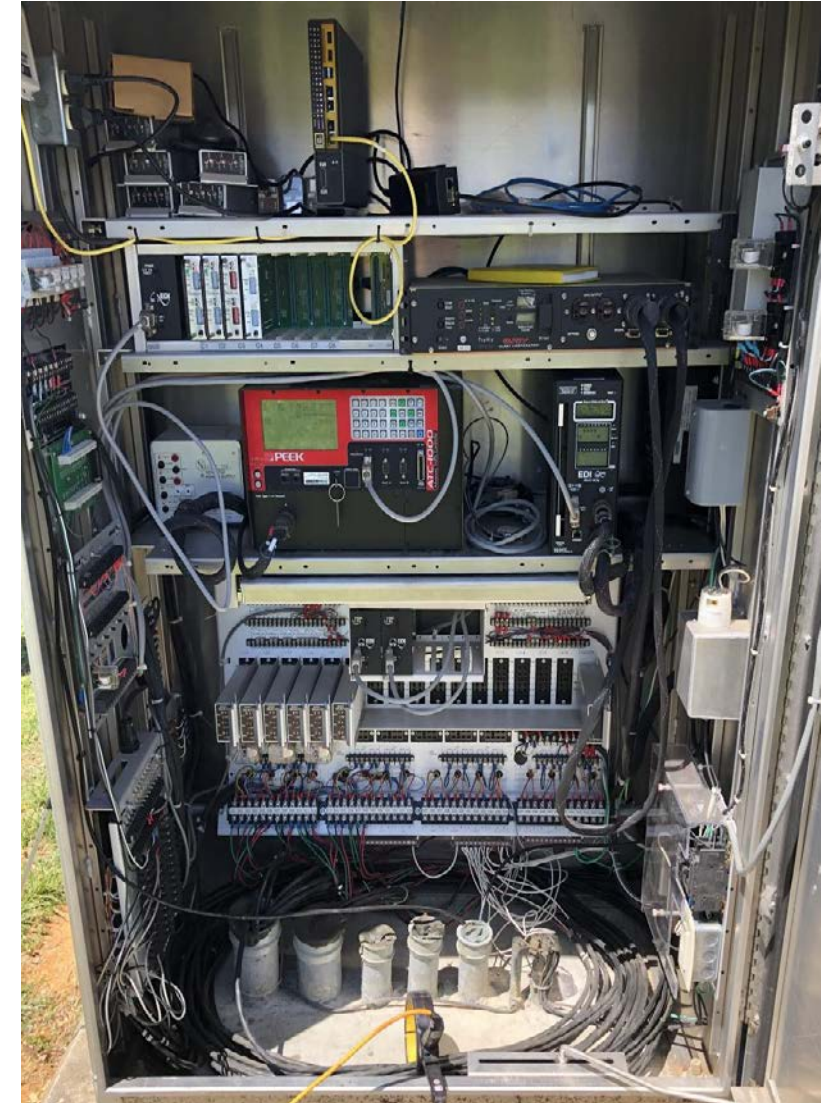

Determine the Fault

Cabinet Problem:

What information does the controller give you?

Active phases/intervals, detection & preemption inputs, active coordination, time-of-day plans, special functions...

Controller phase assignments, ring structure, channel outputs, detector mapping...

- If you have a TS-2, 2070, or an ATC controller:

Check the controller logs and events for fault information & historical data...

Reference the manufacturer's user's manual if necessary.

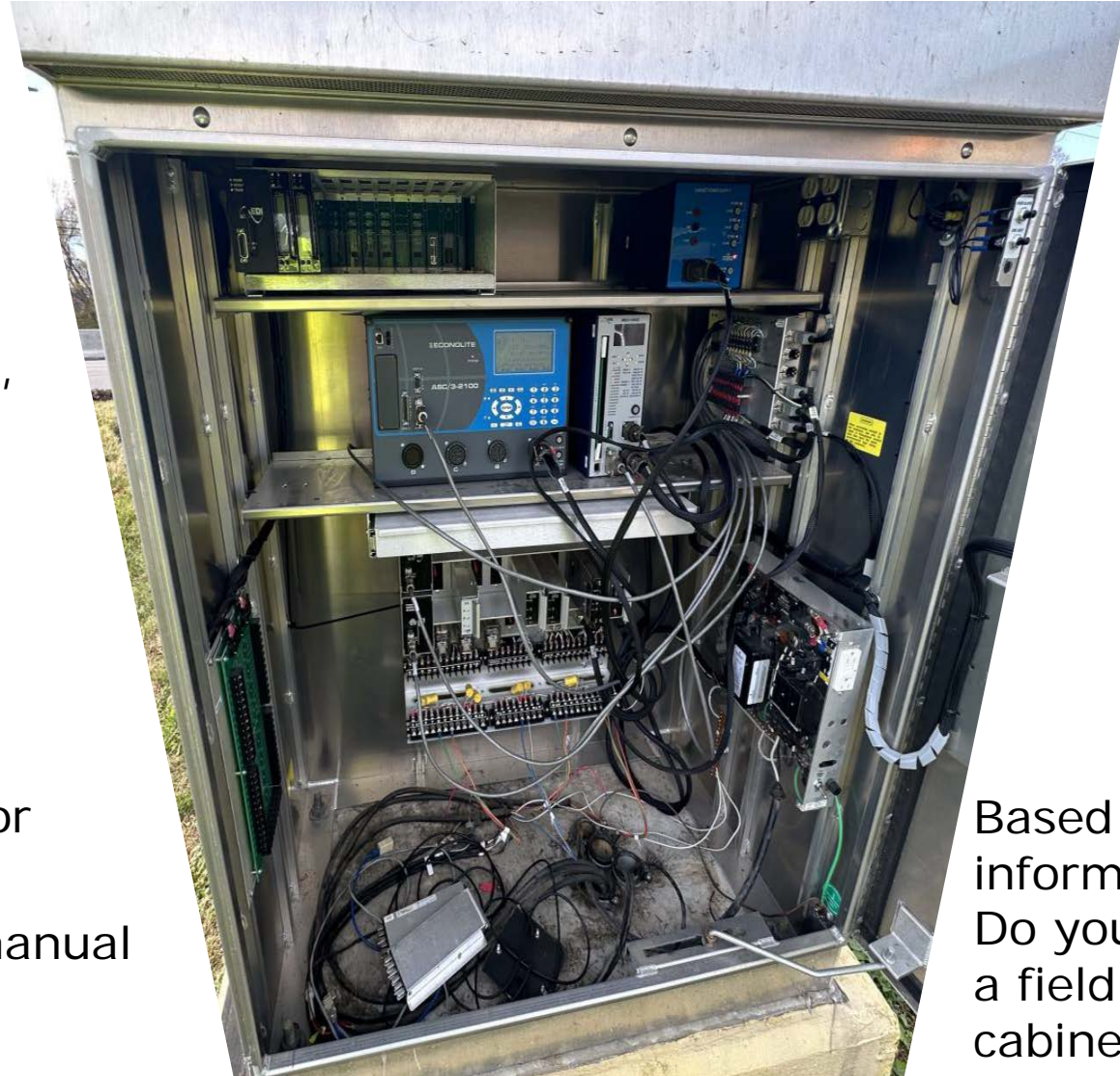

Based on the information given:
Do you have a field or a cabinet problem?

Determine the Fault

MMU STATUS								MFG: RENO A&E								
CHANNEL	1	2	3	4	5	6	7	8	9	0	1	2	3	4	5	6
RED	X	.	.	.	X	.	.	.	X	C	X	X
YELLOW	C	.	C
GREEN
FAULT	X
ENA-Y-CK	.	X	.	X	.	X	.	X	X	X	X	X
FAIL STATS	X	R	L	Y	T	R	A	N	F	R	X	C	O	N	F	L
FIELD CHK	.	D	U	A	L	I	N	D	.	S	P	A	R	E	B	I
EXT WDOG	.	Y	+	R	C	L	R	.	.	S	P	A	R	E	B	I
PORT 1 FL	.	R	E	D	F	A	I	L	.	X	M	I	N	C	L	F
CVM	.	M	M	U	D	I	A	G	.	.	S	T	R	U	P	F
24V MON 1	.	2	4	V	M	O	N	2	.	.	2	4	V	M	O	N
MMU RESET	.	R	E	D	E	N	A	B	L	E	.	L	O	C	A	L
FL TIME	7s	2	4	V	L	A	T	C	H	.	.	C	V	M	L	A

TS2 Controller

Review the **controller logs** and **reports** to locate the fault numbers and troubleshoot.

Test to Isolate Problem Area



- Observe intersection



- Isolate problem to the Field or the Cabinet



- Determine the fault that is causing the problem



- **Test to isolate area causing the problem**



- Correct the problem



- Verify Functionality



- Documenting / Maintenance Log

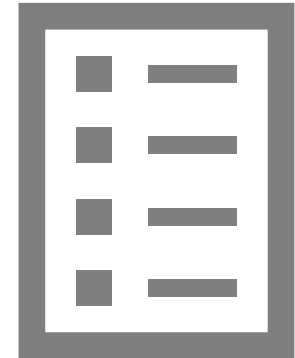

Test to Isolate Problem Area

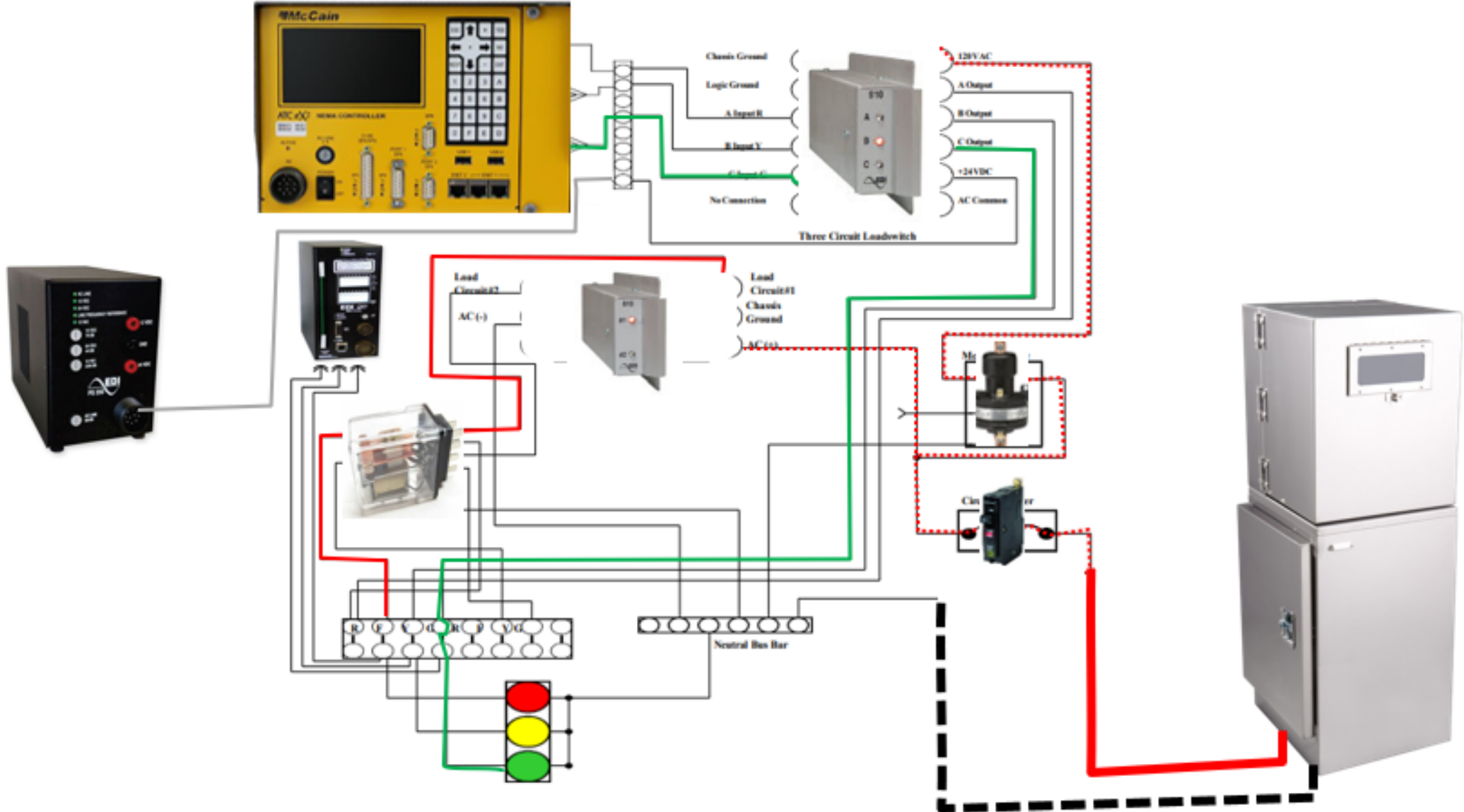

Test to Isolate Problem Area

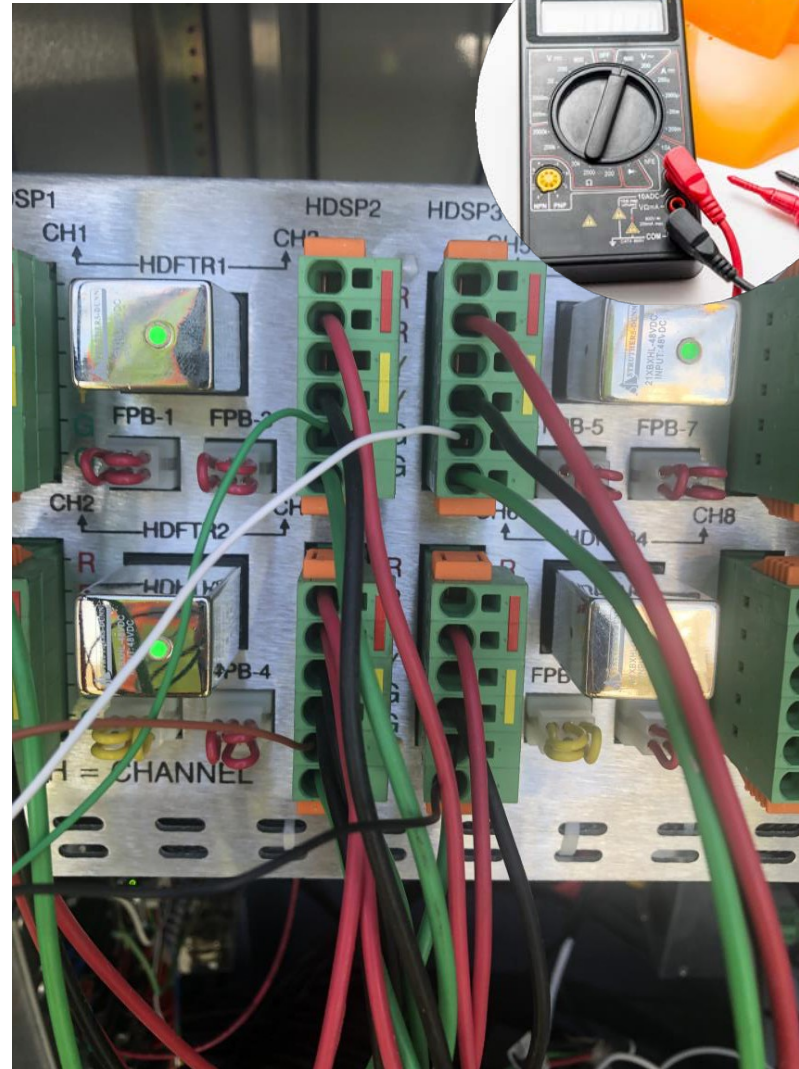
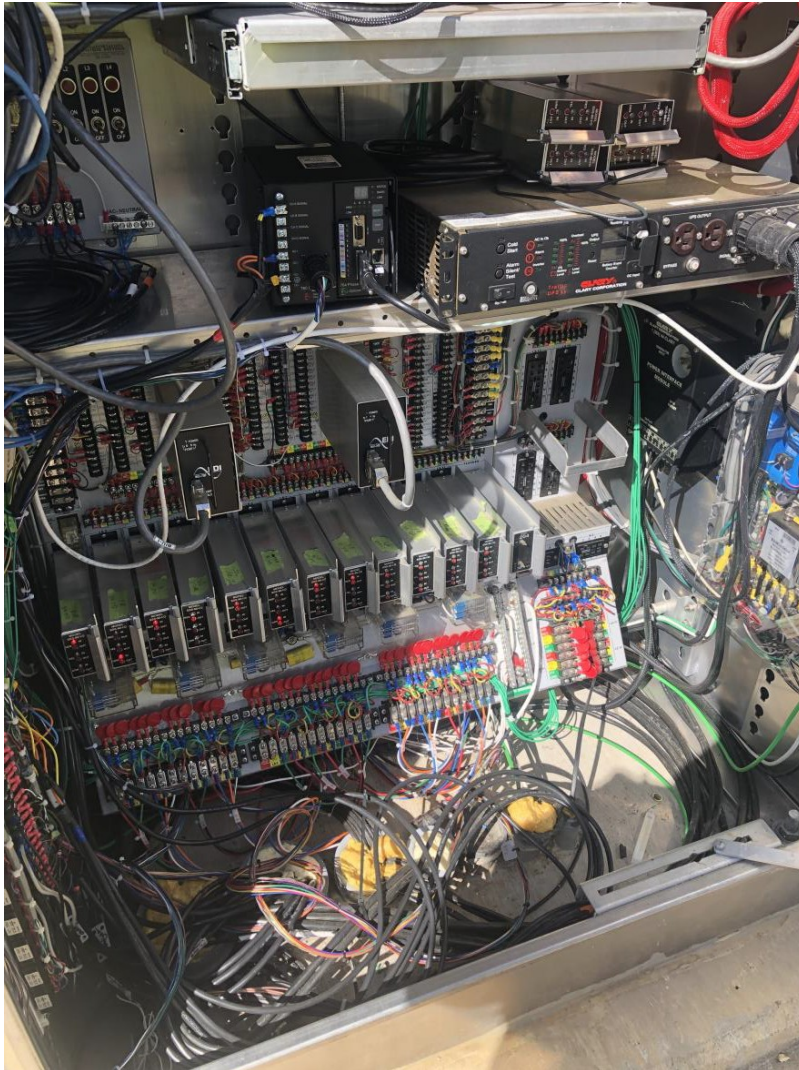

A multimeter can be used to conduct several tests on **field wiring**:

- Voltage
- Resistance
- Current

If you identify any faults or electrical anomalies in the field wiring, document findings and repair, as necessary.

Testing

- **Test the meter before using it to troubleshoot.**

For a voltmeter, test the meter on a known voltage source before using. Your meter should read the correct voltage.

- For an ohmmeter, touch the meter leads together. The display should read 0 ohms, or very close to 0. With the leads apart it should read OL (infinity).

- Identify induction sensors if you are using an induction ammeter (clamp type). Position the sensor around the power input wire.

Set the ammeter to auto. Record the reading and remove the ammeter.

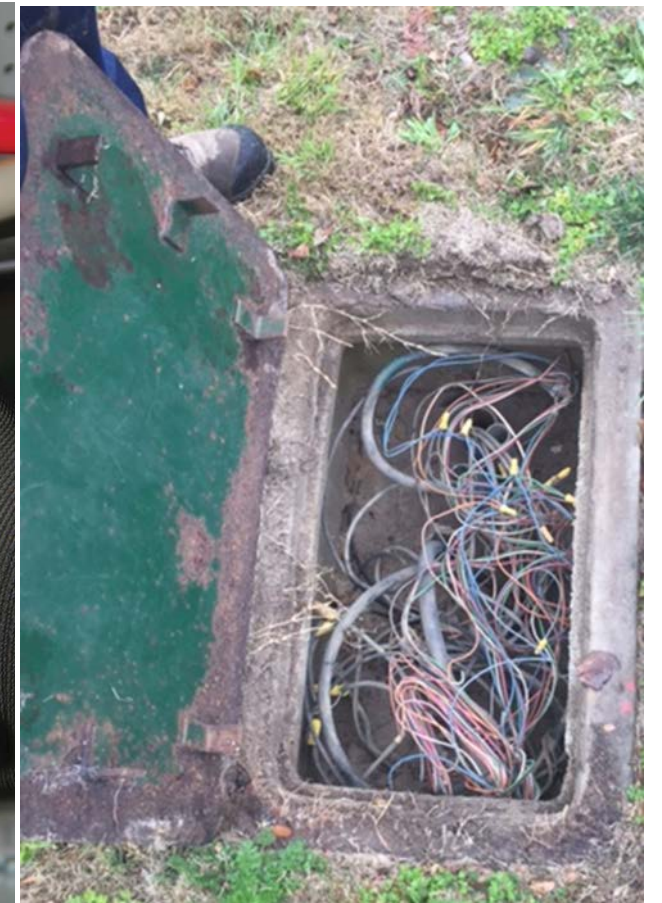

Correct



- Observe intersection



- Isolate problem to the Cabinet or the Field



- Determine the fault that is causing the problem



- Test to isolate area causing the problem



- **Correct the problem**



- Verify Functionality



- Documenting / Maintenance Log



Correct

Field

Field Corrections:

Repair or replace

Repair or replace damaged or missing signal heads, hardware, & wiring.

Repair or replace

Repair or replace poles, mast arms, span wires, & hardware, as necessary.

Repair or replace

Repair or replace underground facilities: pull boxes, conduit, & wiring, as necessary.



Cabinet Replacement:

- ✓ Ensure repair is put back in kind.
- ✓ Any modification should be reviewed and approved prior to install by an engineer.
- ✓ Verify the field wiring
- ✓ Check for proper grounding after install.



Correct

Cabinet

Cabinet Corrections:

Repair or Replace

Inspect & repair/replace wiring, as necessary. Tighten terminal screws and wiring connections, as safe & necessary.

Clean

Clean the cabinet & remove debris. Remove moisture from cabinet and reseal cabinet base.

Check

Check the power feed. Inspect the electrical service, breakers, and fuses.

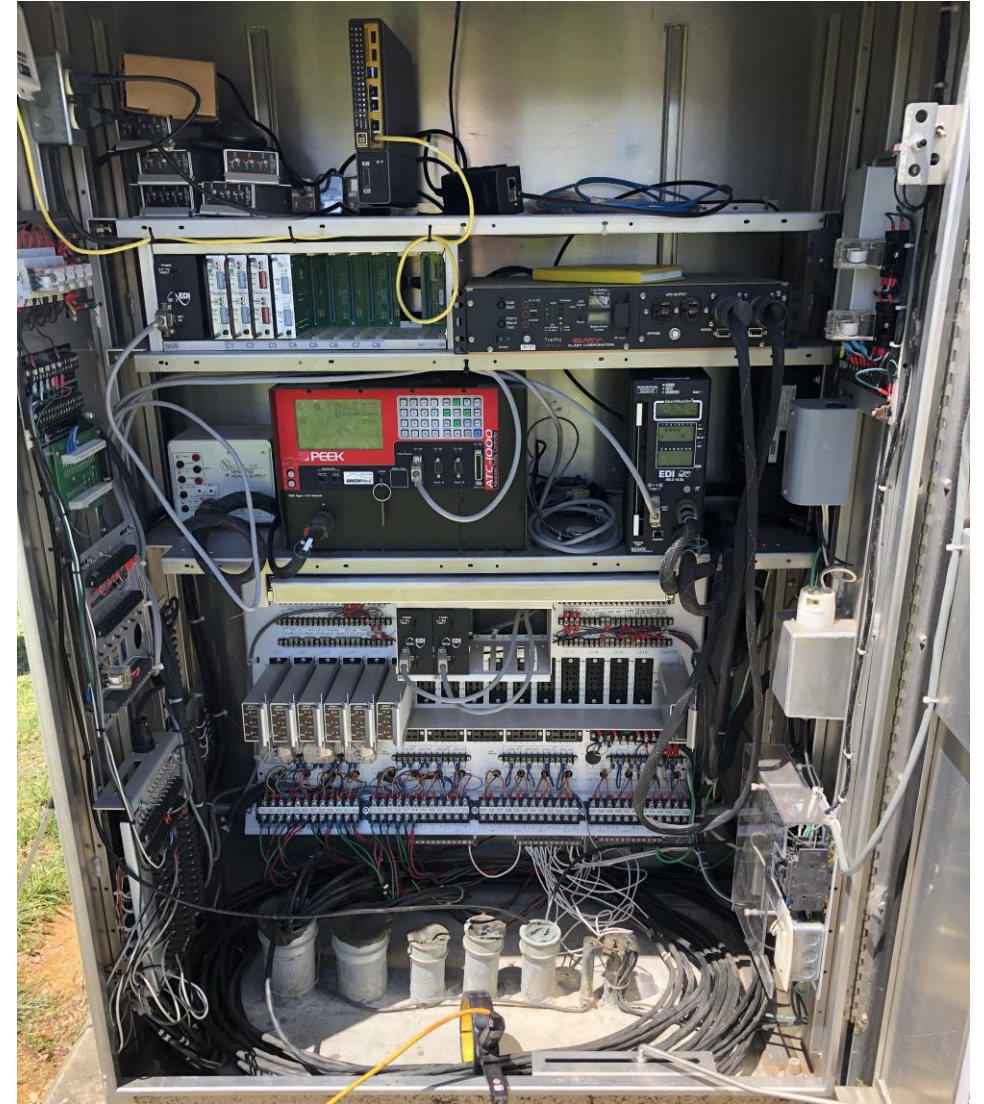

Correct

Cabinet Cabinet Corrections:

Replace Replace faulty device with new one's... load switches, FTR's, flashers, BIU's

Replace Replace power supply, detection & preemption, controller, & monitor with a new or refurbished and tested device. Program, as necessary.

Dispose Properly dispose device or send device back to the manufacturer for evaluation & repairs.



Changing out the MMU/CMU:

- *Unless the existing monitor program card is faulty or new channel assignments are made, reuse the existing program card or data key in the new monitor.*
- If the program card must be replaced or modified:
- Program the MMU/CMU according to the:
 - Intersection phasing diagram
 - Cabinet channel assignments
 - Monitor jumper diagrams



Correct

Replacing or Modifying a NEMA program card:

Add or remove **jumper**s with soldering iron to establish channel compatibility.

It is not a good idea to solder monitors cards in the field.

Soldering is best done in a controlled environment on a bench.

- You're not fighting weather conditions
- You have a stable work area
- You have better control of soldering techniques.

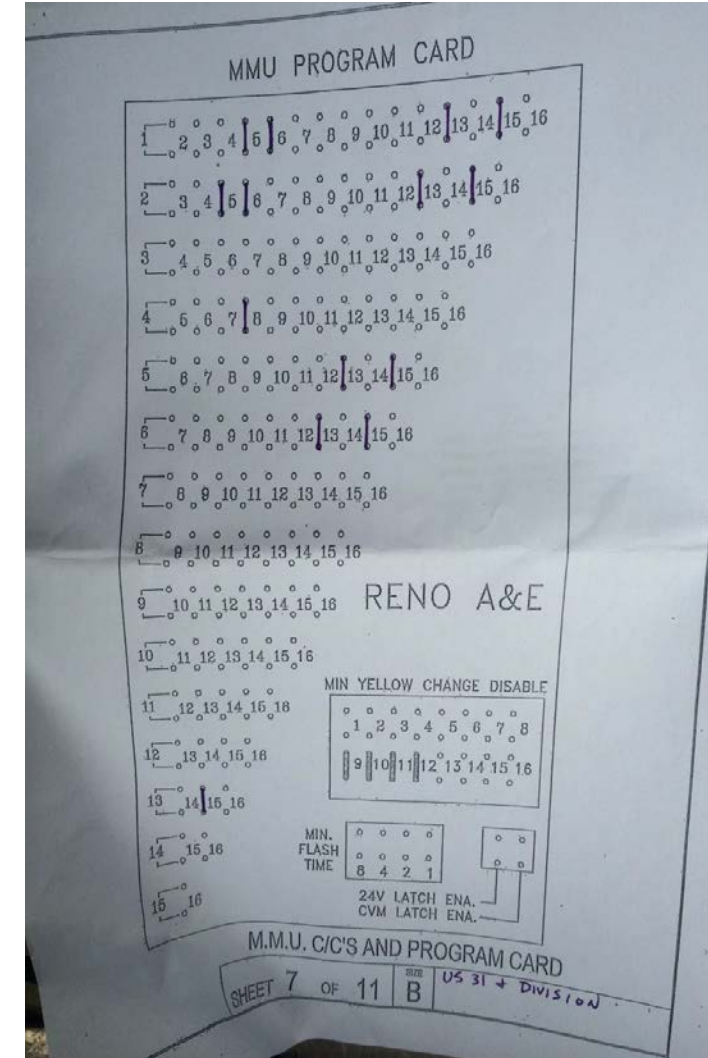
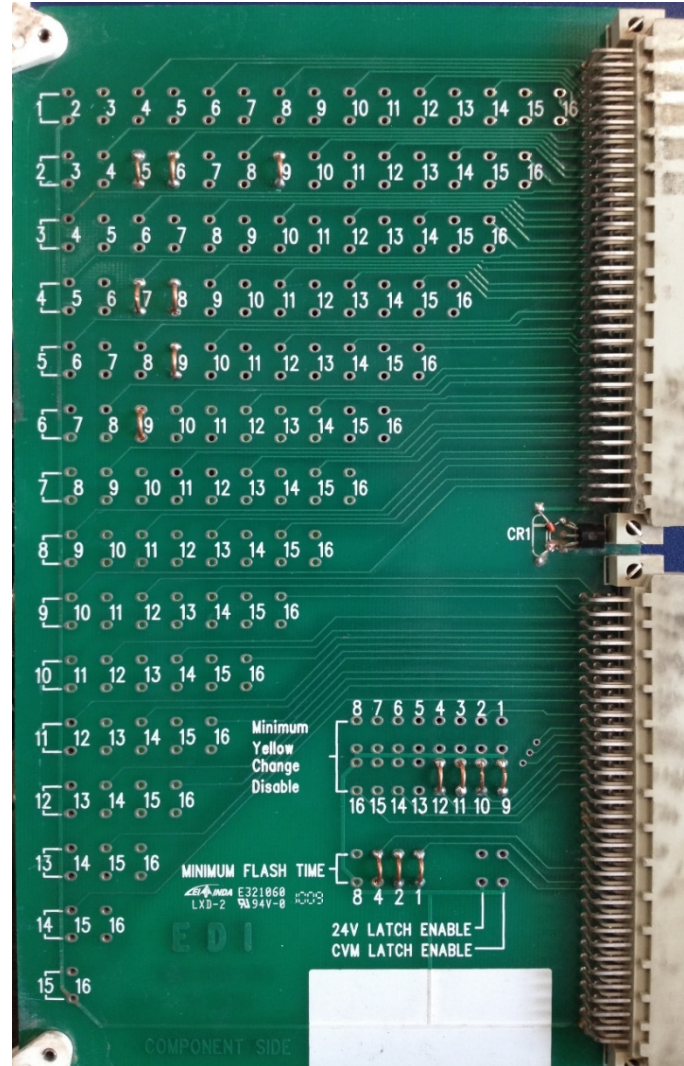

Correct

Inspect the MMU/CMU card for proper or incorrect solder joints:

An ideal through-hole solder joint should have a smooth, shiny concave surface.

Poor solder joints can show signs of:

- Excessive solder that forms a “ball”
- Solder “bridging” across unintended connection points
- Cold joints or Overheated joints
- Lifted pads
- Insufficient wetting
- Solder bubbles/pin holes visible
- Lack of solder in the joint – “solder starved”

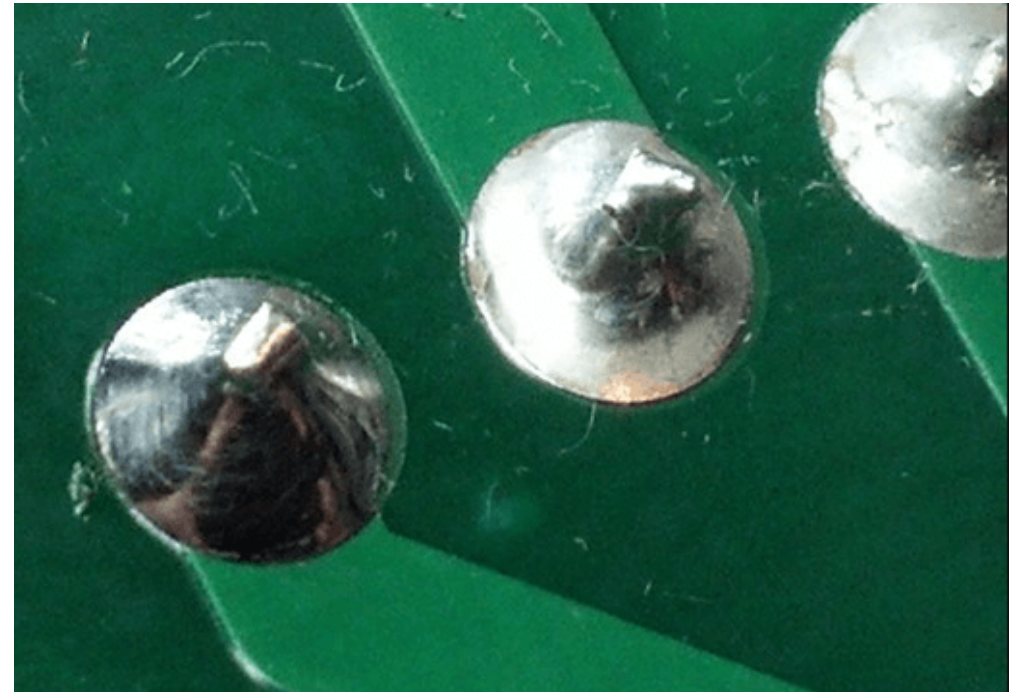

<https://www.seeedstudio.com/blog/2021/06/18/13-common-pcb-soldering-problems-to-avoid/>

Correct

After testing the wires, check the following areas for faulty and/or damaged wires and splices:

- Manholes/vaults
- Pull Boxes/Junction Boxes
- Handholes and covers
- Inside the conduits
- Pinch points
- From the signal heads to the pole base



Correct

✓ If pest damage is present, repair or replace the wiring.

✓ Replace frayed wiring.

✓ Never allow any splices inside conduit or underground.

✓ Use a multimeter to verify voltage and continuity of repaired wiring.



<https://todofibraoptica.com/>



Verify



- Observe intersection



- Isolate problem to the Cabinet or the Field



- Determine the fault that is causing the problem



- Test to isolate area causing the problem



- Correct the problem



- **Verify Functionality**



- Documenting / Maintenance Log



Verify



Verify field wiring – phases to correct signal indications.



Set the clock and calendar in the controller to the proper date and time.



Observe all the cabinet devices as the traffic signal cycles through all the phases.



Walk each approach and visually verify each indication and push button is functioning properly.



Verify mode of operation, free or coordinated?



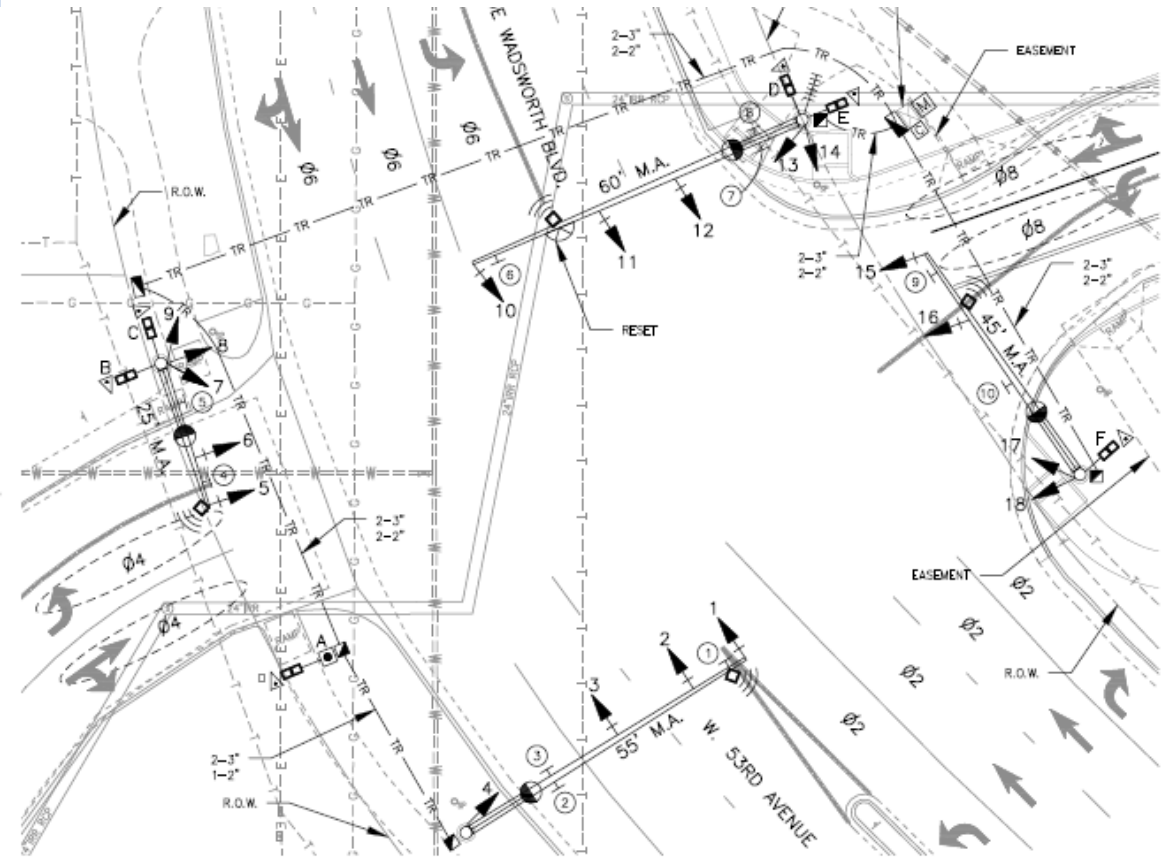

You MUST check Time of Day Plan, if appropriate.



Verify

- 

Use the status display to view **inputs** to the controller.
- 

Look up fault indications and verify they have been fixed.
- 

Review the **detection inputs** if the controller is not picking up vehicles in the field.
- 

Visually match the input numbers to the cars in each lane.

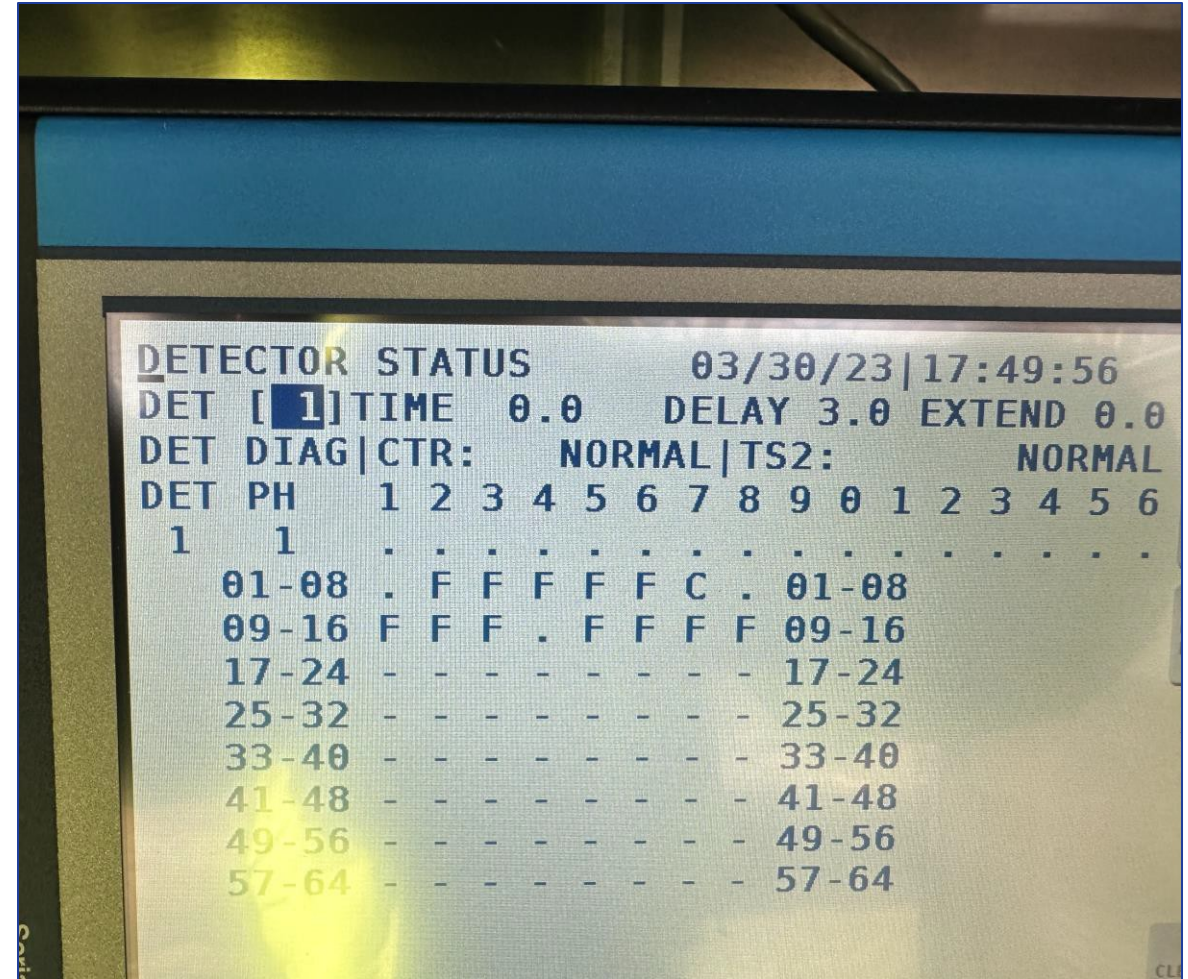

Verify

- Log the time of the emergency response call.
- Log the time of arrival & departure from the signal.
- Document work performed in the **maintenance log** and on the work order.

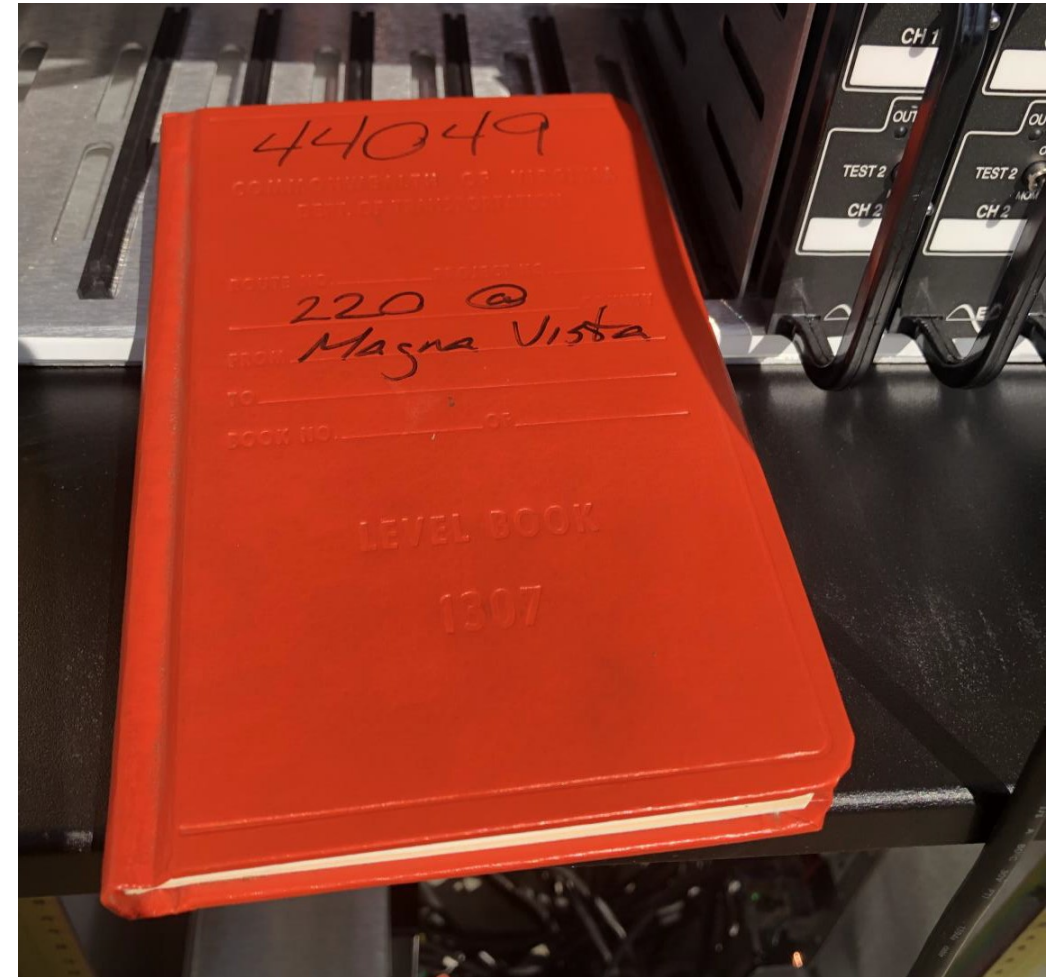

Documentation



- Observe intersection



- Isolate problem to the Cabinet or the Field



- Determine the fault that is causing the problem



- Test to isolate area causing the problem



- Correct the problem



- Verify Functionality



- **Documenting / Maintenance Log**



Maintenance Log (1 of 4)

A traffic signal **maintenance log** is a documentation tool that records all the relevant activities, issues, adjustments, repairs, and maintenance performed on a specific traffic signal. It **serves as an official record** of the actions and operations related to the signal. The log helps maintain transparency, traceability, and accountability in managing the traffic signal system.

Here's what should typically be added to it:

- **Date and Time:** The date and time of each activity should be recorded for reference. This helps to track the chronology of events and identify patterns if any issues recur.
- **Activity Description:** This is a detailed explanation of what has occurred or what actions were taken. This could be a routine inspection, a hardware or software upgrade, a detected malfunction, the resolution of an issue, etc.
- **Persons Involved:** Names or IDs of the technicians or engineers who performed the task. This helps in identifying who to contact for more information if the need arises.
- **Equipment Details:** Any change in the equipment, whether it's an addition, removal, repair, or replacement, should be noted. This also includes any software or firmware versions in use.
- **Observations and Notes:** These can be comments on the state of the cabinet, performance notes, or any anomalies observed. This can also include potential recommendations for future action.

Maintenance Log (2 of 4)

The people authorized to edit a traffic signal maintenance log typically include traffic engineers, technicians, or other authorized personnel involved in the maintenance, repair, or monitoring of the traffic signal system. The authorization is typically granted by the traffic management department or the respective authority in charge.

The importance of a traffic signal maintenance log lies in the following aspects:

- **Transparency and Accountability:** The log serves as an official record of all actions related to the traffic signal cabinet. It holds those involved in the maintenance and operation accountable for their actions.
- **Traceability:** It allows the tracing of issues to their root cause, providing a clear timeline of events leading up to an issue. This is crucial in preventive maintenance and problem-solving.
- **Continuity:** If different teams or individuals are working on the same cabinet at different times, the log ensures everyone has access to the full history and context, facilitating a smoother transition and continuous work.
- **Compliance and Legal Reasons:** Logs might be required for regulatory compliance or could serve as legal proof in case of accidents or disputes involving the traffic signal.
- **Data Analysis and Improvement:** Over time, the data from the log can be analyzed to identify recurring issues, peak times for certain problems, or components that frequently fail. This can lead to systemic improvements, cost savings, and more efficient traffic management.

Maintenance Log (3 of 4)

Maintaining a log requires a systematic approach to record and track relevant information.

Here's a suggested method for effectively managing a traffic maintenance log:

- **Determine the Log Format:** Decide on a log format that suits your needs. You can create a digital log using a work and asset management software or use a dedicated physical log. Ensure it includes fields for essential information, such as date, time, location, description of the issue, actions taken, and any additional notes.
- **Define Log Entry Requirements:** Establish clear guidelines for what should be included in each log entry. This may include documenting events such as equipment malfunctions, repairs, maintenance activities, or any significant incidents related to the traffic cabinet.
- **Assign Responsibility:** Designate a specific individual or team responsible for maintaining the traffic maintenance log. This person should be knowledgeable about the equipment and its operations.
- **Document Relevant Information:** For each log entry, record the date and time of the event, the location of the traffic cabinet or relevant components, and a detailed description of the issue or activity. Include any observations, error codes or other relevant information that may help identify patterns or diagnose recurring problems.
- **Track Maintenance Activities:** Record all maintenance and repair activities performed, including the type of work, the date and duration of the maintenance, and the personnel involved. Note any replacement parts used, or adjustments made.

Maintenance Log (4 of 4)

Maintaining a log requires a systematic approach to record and track relevant information.

Here's a suggested method for effectively managing a traffic maintenance log (cont.):

- **Include Supporting Documentation:** Attach any supporting documentation, such as work orders, invoices, or photographs to the log entry if applicable. This additional information can provide context and aid future analysis.
- **Regular Updates:** Ensure the maintenance log is updated in a timely manner after each event or activity. Prompt and accurate entries will help maintain an up-to-date record and aid troubleshooting efforts.
- **Review and Analysis:** Periodically review the log to identify trends, recurring issues, or areas that require attention. Analyzing the log entries can help identify patterns, prioritize maintenance efforts, and make informed decisions for optimizing overall performance.
- **Secure Storage:** Keep the log or digital file in a secure location to prevent unauthorized access or loss of data. Regularly back up digital logs to ensure data integrity.
- **Training and Communication:** Provide training to personnel responsible for maintaining the log to ensure consistent and accurate documentation. Communicate any updates or changes in the log format or procedures to the relevant stakeholders.

Knowledge Check: Repair or Replace?

Evaluate each situation below and determine if the component needs to be **repaired or replaced**.

- a) Wiring: The wire damage is located underground.
- b) Signal head: The head signal is safe, but the indications are faulty.
- c) Signal head: There is physical damage to the signal head.
- d) Wiring: There is only a small portion of spare wiring.

Knowledge Check: Repair or Replace?

Evaluate each situation below and determine if the component needs to be **repaired or replaced**.

- a) Wiring: The wire damage is located underground. **Replace wiring**
- b) Signal head: The head signal is safe, but the indications are faulty. **Repair signal head**
- c) Signal head: There is physical damage to the signal head. **Replace signal head**
- d) Wiring: There is only a small portion of spare wiring. **Replace wiring**

Knowledge Check: Multiple Choice

What should you do if the signal indications do not function properly after replacing the faulty signals?

- a) Review cabinet blueprints to verify the wiring method.
- b) Check for physical damage to the signal head.
- c) Review cabinet blueprints to verify proper voltage to each light.
- d) Call a senior technician to replace the signal head.

Knowledge Check: Activity

Imagine you were tasked to inspect the cabinet environment for any electrical damage. What is the correct course of action? Order the letters below to reflect the correct order.

A Inspect wiring and relay switch

B Check for any smell of burnt electrical components

C Listen for any electrical noises

D Document all findings

E Check reports in the controller and MMU to isolate the problem area

F Check if the cabinet is energized

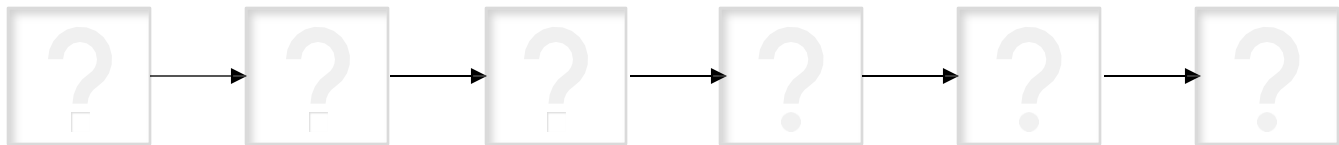

Knowledge Check: Activity

Imagine you were tasked to inspect the cabinet environment for any electrical damage. What is the correct course of action? Order the letters below to reflect the correct order.

A Inspect wiring and relay switch

B Check for any smell of burnt electrical components

C Listen for any electrical noises

D Document all findings

E Check reports in the controller and MMU to isolate the problem area

F Check if the cabinet is energized

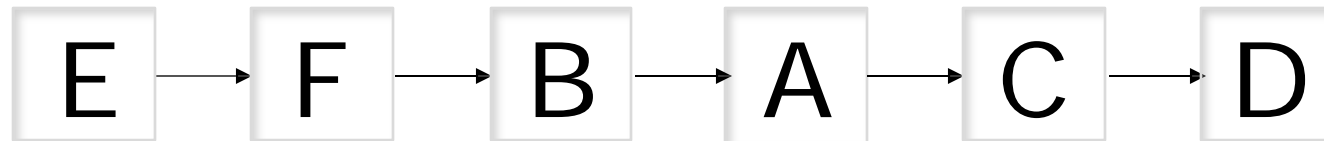

Knowledge Check: Fill the Blanks

Fill in the blanks with the correct words from the box below:

ABC connectors

dual indications

SDLC connectors

controller voltage monitor

1. TS1 cabinets/controllers have _____, while TS2 cabinet have _____.
2. Examples of common types of faults in the MMU/MCU include _____ and _____.

Knowledge Check

Identify the component highlighted in each number.

- 1)
- 2)
- 3)
- 4)
- 5)

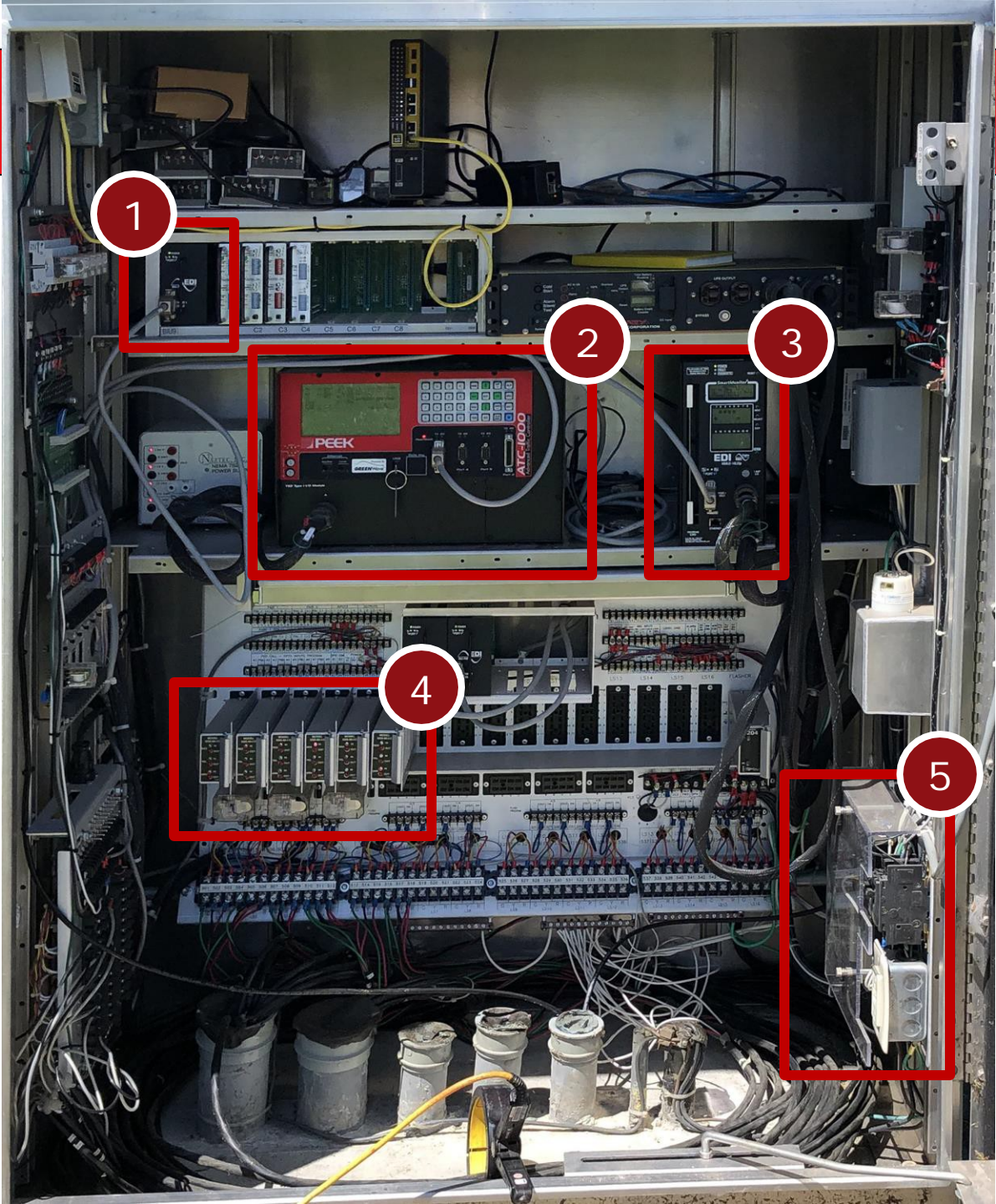

Knowledge Check

Identify the component highlighted in each number.

- 1) BIU
- 2) Controller
- 3) MMU
- 4) Loadswitches
- 5) Power Panel

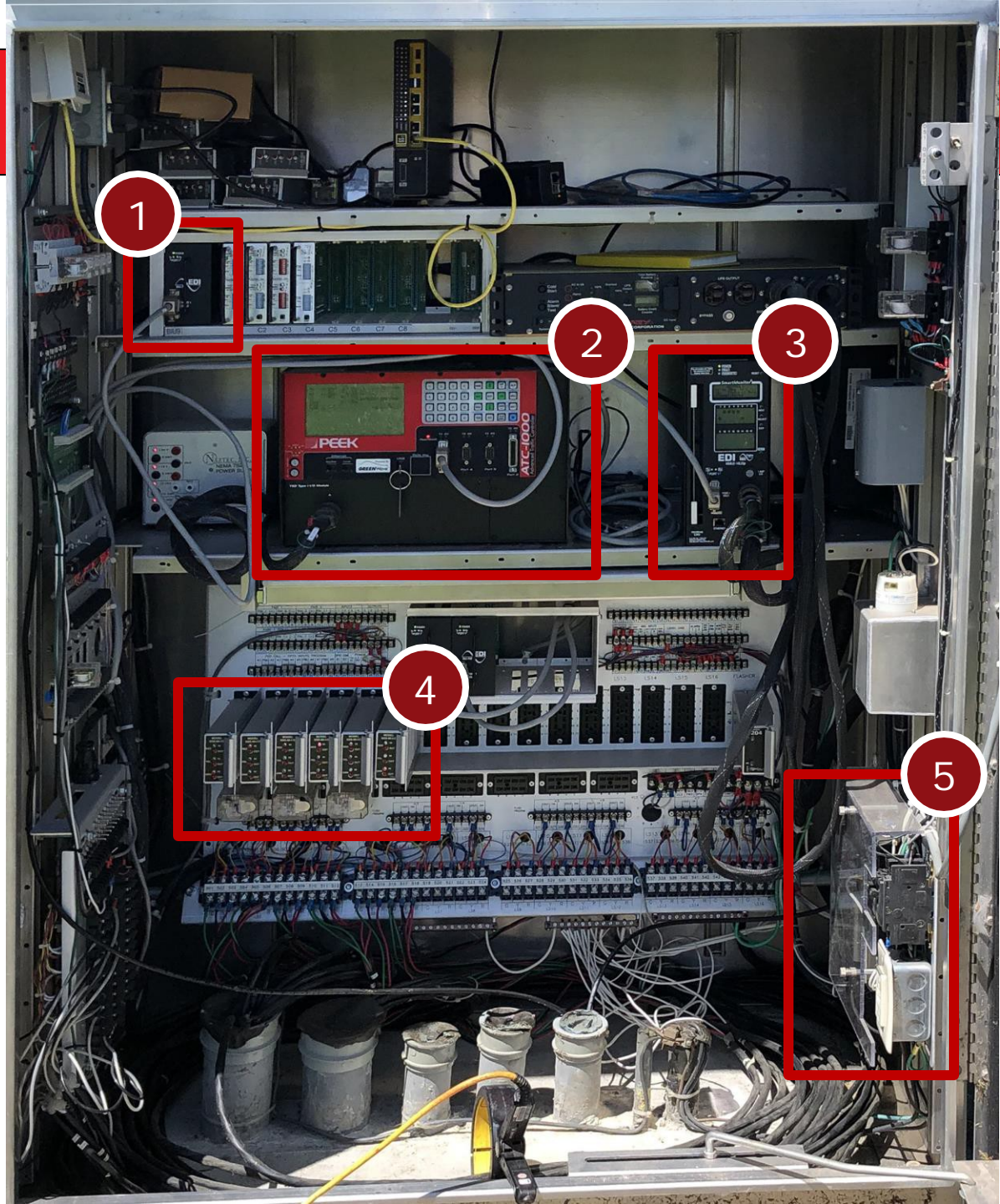

Knowledge Check: Multiple Choice

In a NEMA TS1 cabinet, a loop detector provides a call or input to the controller by providing:

- a) 12 VDC to the controller on the input pin
- b) 24 VDC to the controller on the input pin
- c) a 0 VDC logic ground to the controller on the input pin
- d) a serial input to the controller through an SDLC input

Knowledge Check: Multiple Choice

Which statement does NOT include a step to evaluate detection inputs to the controller?

- a) Using the display to view a map of inputs to the controller to check for fault indications.
- b) Perform a “one-call” or 811, to check for any utilities located underground.
- c) Review the detector inputs if controller is not picking up vehicles in the field.
- d) Matching the phase input to the cars in each lane.

Knowledge Check: Multiple Choice

An approach has four signal heads for the through lanes, three overhead and one on the corner. In a cabinet without load resistors, how many reds must fail before the CMU/MMU in the cabinet puts the cabinet in flash?

- a) 1
- b) 2
- c) 3
- d) 4

IMSA Traffic Signal Field Technician II

Session 11: Preventative Maintenance (PM)



Advancing the Future of Public Safety

Preventative Maintenance (PM)

A thorough PM program follows industry guidelines and yields the following benefits:

- Identify and prevent potential equipment failures before they happen
- Minimize costly repairs due to electrical damage
- Minimize the frequency and severity of traffic signal malfunctions
- Preserve and enhance equipment reliability
- Maximize life span of traffic signal installations
- Minimize the agencies exposure to liability

Preventative Maintenance (PM)

Items to be Inspected, Cleaned, Adjusted or Replaced:

- Signal Heads
- Pedestrian Assemblies
- Signal Poles
- Pull Boxes
- Traffic Signal Cabinet
- Detection
- Battery Back Up
- Electrical Services

Preventative Maintenance (PM)

Items to be Inspected, Cleaned, Adjusted or Replaced:

Traffic Signal & Pedestrian Heads

- Verify heads aligned relative to lanes and at the proper height
- Check for cracks or damage on visors, louvers, signal housing, & mounting hardware
- Check for tears on gaskets in housing
- Check terminal connections for correct wiring and tightness
- Visually check all signal cables & entrance grommets
- Verify all LEDs are operational
- Verify the time in each countdown ped head. The previous ped clearance time is recorded in the countdown module for the next time that ped phase is serviced.



Test Push Button Function

- Verify that each **pedestrian push button** functions as intended.
- Verify the input to the controller.
- Check that mechanical buttons push and release.
- Check if pushing the button results in the correct walk indication, sound, motion, or instructions.



Verify Actuation/Isolation Board



Replace actuation

First, inspect actuation for proper function. If not functioning properly, replace the actuation and test again.



Repair actuation

Inspect pedestrian actuation board inside the cabinet. Repair the actuation if there is no power going to the area.

Check for damaged ped button cables; i.e., cut cables, shorted or grounded cables.

Verify Input Assignments



Assignments

Verify ped phase assignments and indications in the field by observing the response. Reprogram phases as necessary in the controller.



<https://thedailytexan.com/>

Push button

Check if the screen indicates a call has been made when pushing the button.



Faulty button

If the push button does not execute a call or fully depress, it could be stuck or damaged.

Preventative Maintenance (PM)

Items to be Inspected, Cleaned, Adjusted or Replaced: **Signal Poles**

- Verify Hand Hole Covers
- Verify End Caps
- Verify Pole Caps
- Inspect Foundations/Anchor Bolts
- Inspect Pole Welds
- Check Mounting Hardware
- Check Mounting Hardware on Signs
- Verify every pole is properly bonded & grounded



Inspect Pole and Foundation

- Inspect steel, aluminum, & concrete **poles** for physical damage such as dents, cracks, chipping, rust, scratches, or sagging.
- Inspect the **pole foundation** for cracks, foundation shift, broken pieces, bent bolts, or loose leveling nuts
- Notify superiors of damage found



Inspect Connections and Weld Points



Inspect pole connections and anchor bolts. Check if:

- Anchor bolts show signs of corrosion
- Bolts/clamps need tightening
- There is damage to any weld points
- Grouting is missing or cracked

Secure Handholes

- Inspect the **handhole** to ensure access is secured from the public with a cover and bolt or screw.
- Repair, if necessary.



Inspect Drainage

- Drill a hole in the bottom of the grout to allow drainage.
- If pole is elevated from the foundation, clear any debris.
- If a pole needs to be replaced, contact the proper personnel.



Preventative Maintenance (PM)

Items to be Inspected, Cleaned, Adjusted or Replaced: **Pull Boxes**

- Check Boxes & Lids for Cracks or missing pieces
- Check the final grade of the box
- Check ground bushings, straps & ground rod connections
- Verify seal in conduits
- Verify signal cables are not being crushed by the pull box lid
- Remove rodents and clean debris



Preventative Maintenance (PM)

Items to be Inspected, Cleaned, Adjusted or Replaced:

Traffic Signal Cabinet

- Verify Controller Operations
- Check Cabinet Ground Reading
- Verify Cabinet Light
- Check GFI Receptacle
- Check/Replace Cabinet Filter
- Visually Check Load Switches and Flasher Relay
- Lubricate Hinges & Locks
- Check Terminal Connections
- Vacuum Cabinet
- Spray Insecticide if needed
- Verify Conduits are Sealed
- Verify Conflict Monitor has been Tested
- Verify Communication, Controller and CM All Online
- Check Cabinet Base has Sealant



Communication Devices



Intersection Communication Devices

Inspect poles for communication devices (e.g., directional antennas).

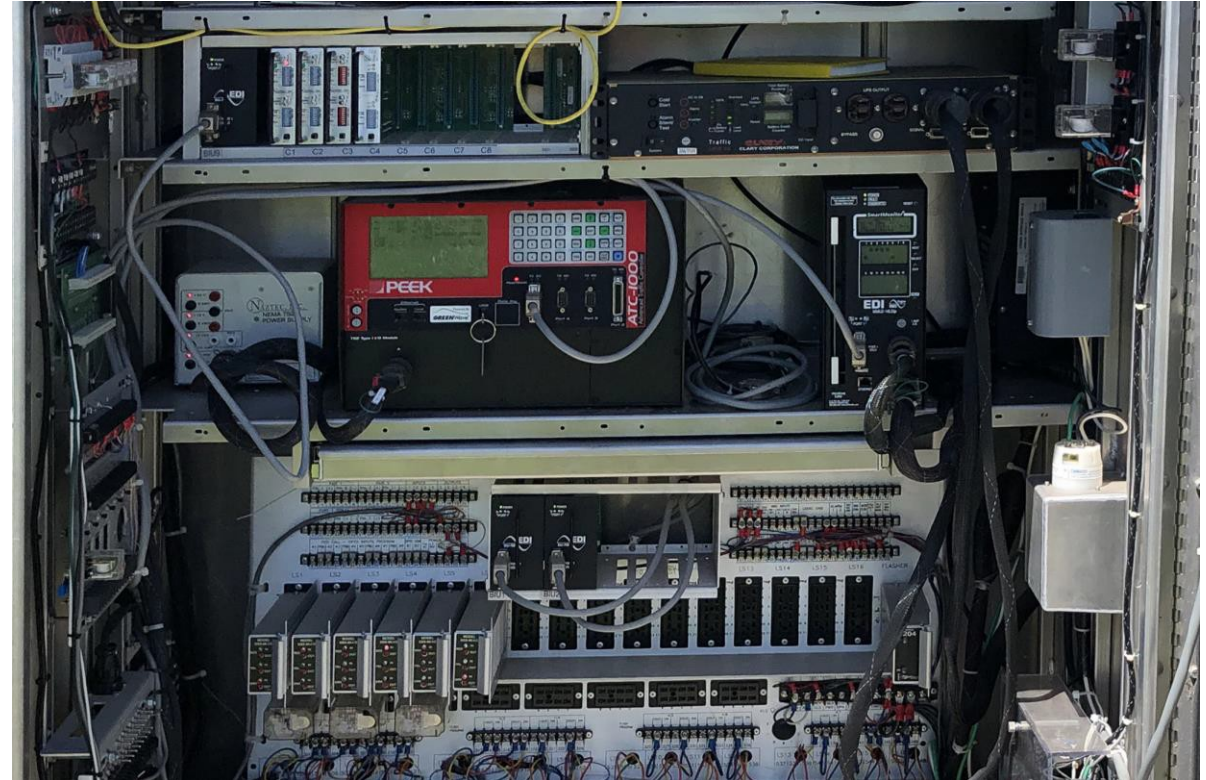

Cabinet Communication Devices

Inspect signal strength of cabinet and controller for IP address confirmation and fiber modems.

Controller & MMU/CMU Program

- Check the date and time in both units and set accordingly
- Verify the controller inputs
- Verify the MMU/CMU inputs
- Verify the harnesses are seated correctly

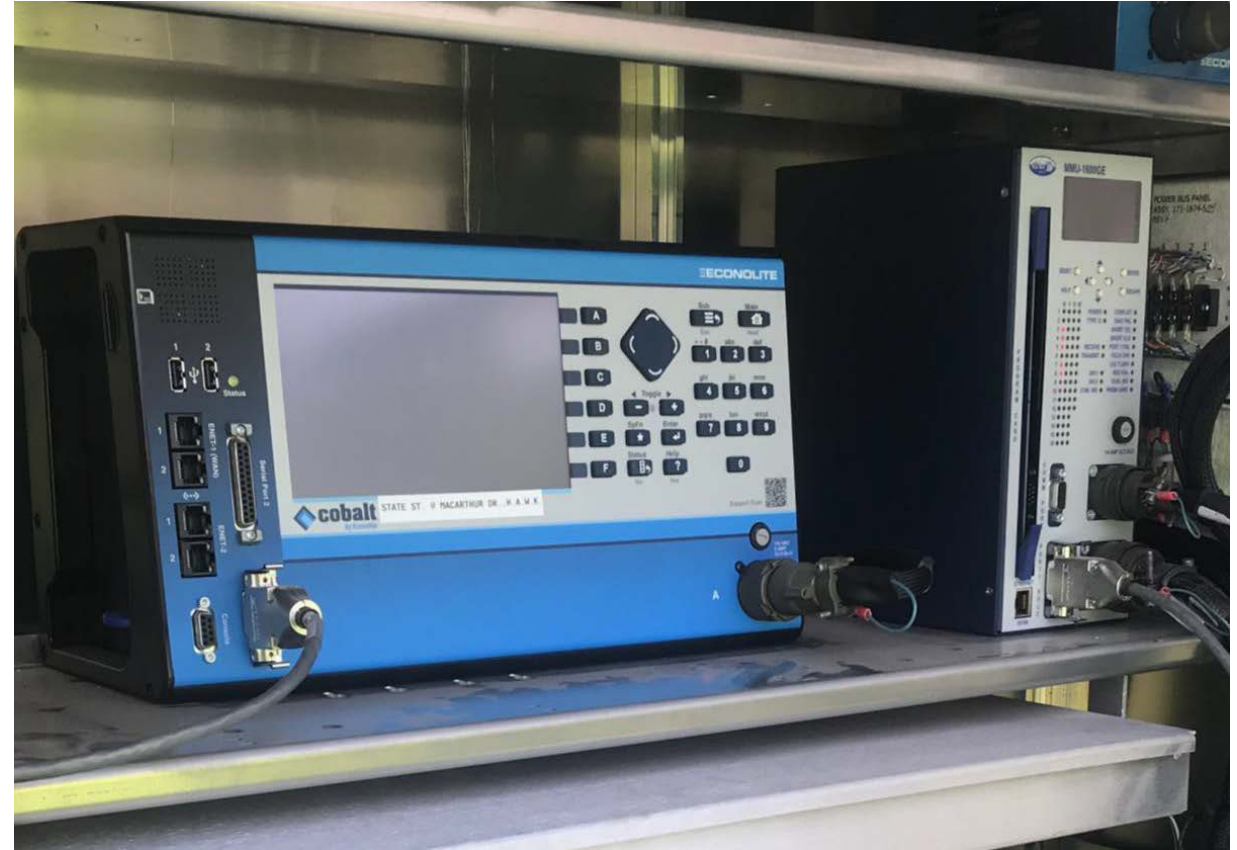

Locks, Hinges, and Seals

Ensure they remain functioning, lubricated, and rust-free.

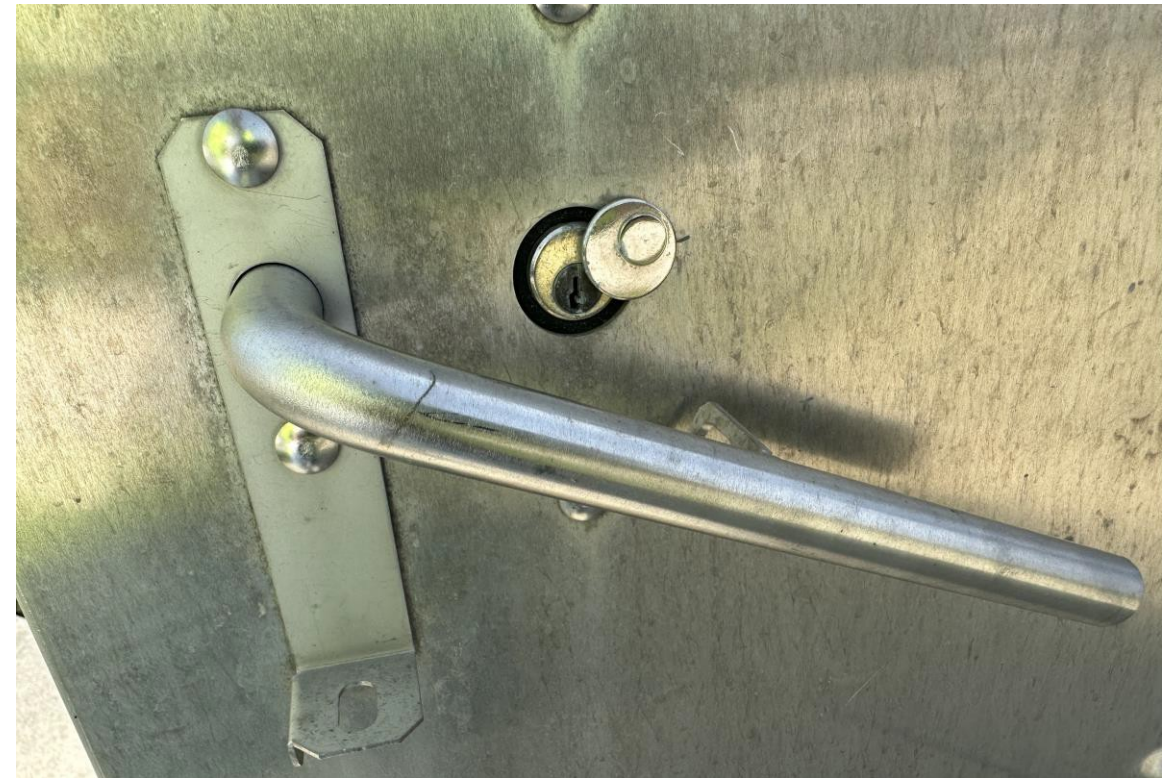

Check Thermostat and Fan

- Test the thermostat by turning down the temperature to the lowest setting and check if the fan powers “on”.
- Return the temperature setting on the **thermostat** to less than 90 degrees.

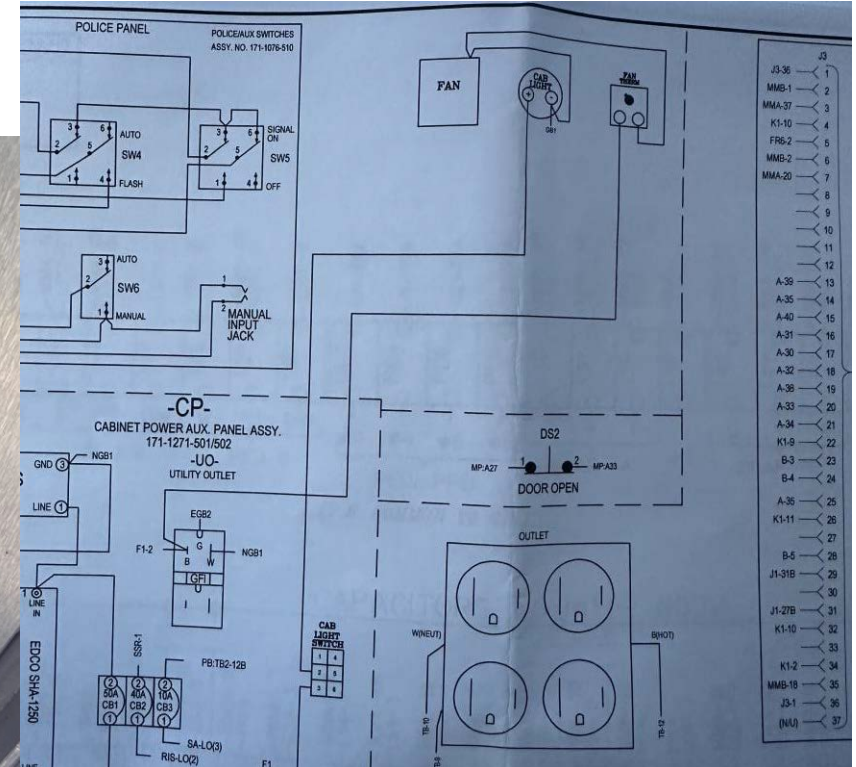
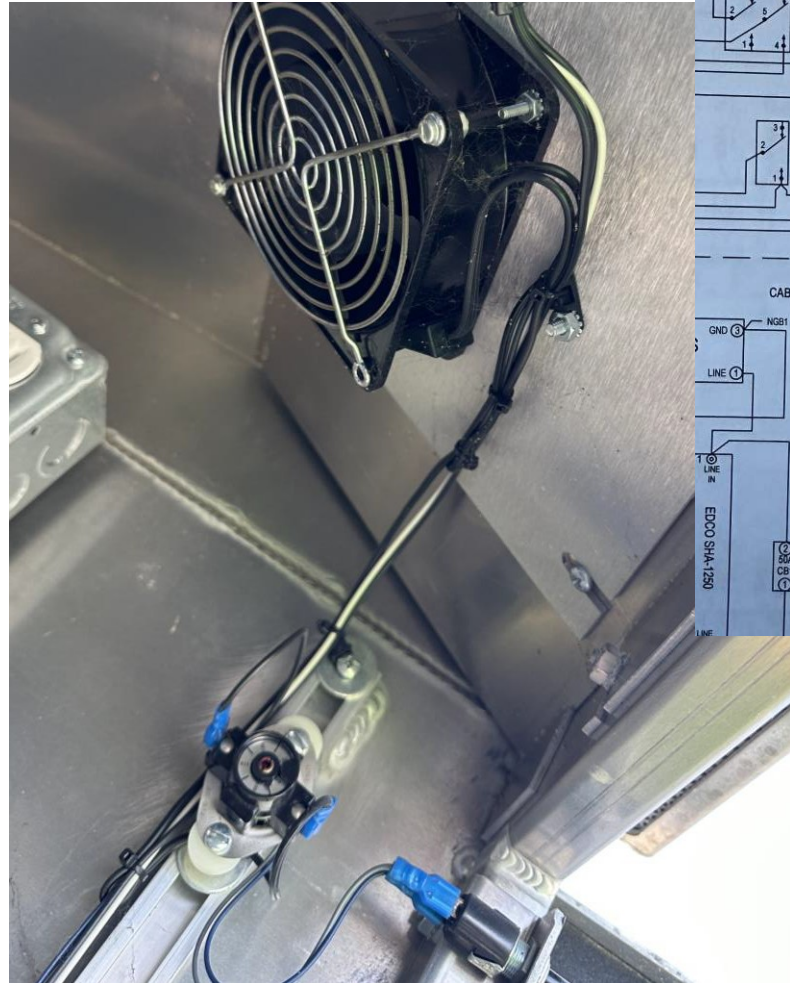

Check the Power Panel

- The fan may not start when the ambient temperature is lower than the lowest setting on the thermostat.
- If the fan does not start, use a **multimeter** to check for voltage in the thermostat and fan.
- If there is power going to the thermostat and fan, but they are still not working, replace them.
- If there is no power, check the power panel.

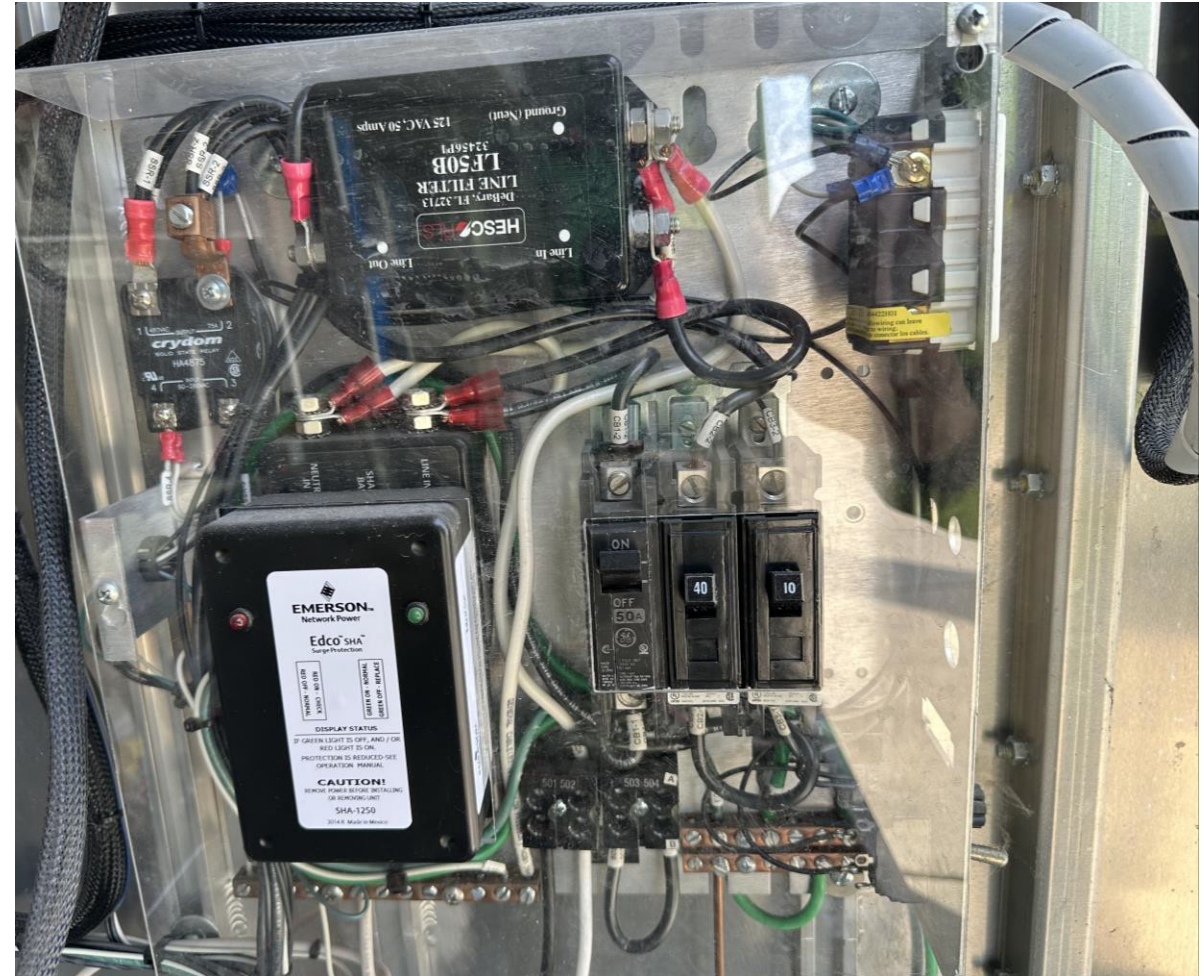

Preventative Maintenance (PM)

Items to be Inspected, Cleaned, Adjusted or Replaced:

Detection

- Verify Detection calls in Controller
- Clean Camera Lenses
- Verify Camera Operation
- Check Camera Zone Placement
- Verify Detector Termination Panel
- Check Radar Detection Zone Placement
- Verify Detector Assignment
- Verify Emergency Vehicle Pre-emption Operational
- Check all Loop Amplifiers
- Check Detector Splices if not operational



Preventative Maintenance (PM)

Items to be Inspected, Cleaned, Adjusted or Replaced: **Battery Back-up Unit**

- Verify Incoming Line Voltage
- Verify DC Battery Output
- Verify AC Inverter Output
- Test System Manually
- Load check each battery individually
- Replace/Clean UPS Filter
- Download Event Logs from UPS



Identify Battery Faults

- Inspect the **backup battery** for faults indicated on the UPS display screen.



- Verify that the batteries are **charging** and check the battery connections.
- Replace battery(s) according to the fault indicator.



Inspect Battery for Damage

- Inspect the battery terminals for **corrosion**/sulfation.
- Inspect the battery for **damages** such as swelling or cracks.
- **Replace the battery** if swelling, cracks, or other damage is present.
- Load check each battery and **test voltage**.



www.batteryreconditioningtips.com



<https://legacycarts.com>



<https://www.tacel.ca/>

Cycle Battery to Ensure Proper Function

- Use the **battery test mode** option on the inverter to check the backup battery. Verify battery voltage(s)
- Replace the **backup battery** if the UPS is not powering the intersection when the main battery is disconnected.
- Turn on the power at the intersection.



Preventative Maintenance (PM)

Items to be Inspected, Cleaned, Adjusted or Replaced: **Electrical Services**

- Check Meter/Disconnect Lock
- Check and Secure Transformer Door
- Verify Incoming Voltage Reading
- Verify Load Side Voltage Reading
- Check Loose Breakers
- Visually check Conductors
- Verify Electrical Service Ground Reading



Preventative Maintenance (PM)

Document work performed in the **maintenance log** and on the work order.

Make sure to notify the responsible parties in charge of the work that was performed.

Ensure good record keeping of PM Program.



Knowledge Check: Multiple Choice

Which alternative below presents a correct action to inspect a pedestrian actuation?

- a) Inspect the pole foundation to identify physical damage.
- b) Inspect the bottom of the pole to ensure that there is proper drainage.
- c) Use multimeter to verify voltage and continuity of wiring connected to the push button.
- d) Replace actuation if the assignments are not aligned.

Knowledge Check: True/False

While visible solder bubbles are acceptable in soldering joints, we should re-solder if there is any soldering leaking through the jumper board.

True

False

Knowledge Check: Multiple Choice

What should we do if we see an indicator light or display screen with an “incorrect program” message in the controller display?

- a) Reprogram the phase in the MMU/CMU and the controller.
- b) Check the wiring schematics and intersection layout.
- c) Reprogram the timing plan in the MMU/CMU and the controller.
- d) Check if the clearance intervals match the permits and blueprints.

IMSA Traffic Signal Field Technician II

Glossary



Advancing the Future of Public Safety

Glossary of Terms

Accessible Pedestrian Signal – a device that communicates information about pedestrian timing in non-visual format such as audible tones, verbal messages, and/or vibrating surfaces. (MUTCD)

Active Grade Crossing Warning System – the flashing-light signals, with or without warning gates, together with the necessary control equipment used to inform road users of the approach or presence of trains at highway-rail grade crossings or highway-light rail transit grade crossings. (MUTCD)

Active Sensor – a sensor that transmits energy, a portion of which is reflected or scattered from a vehicle or other objects and surfaces in its detection zone, back toward the receiving aperture of the sensor.

Actuated Traffic Signal Controller – the computer in the cabinet that receives vehicle detection and/or pedestrian sensors to improvise appropriate signal timing. It is not a pre-timed computer.

Actuated Operation – a type of traffic control signal operation in which some or all signal phases are operated on the basis of actuation. (MUTCD)

Actuation – initiation of a change in or extension of a traffic signal phase through the operation of any type of detector. (MUTCD)

Glossary of Terms

Advanced Transportation Controller (ATC) – a standardized effort intended to provide an architecture hardware and software platform that can support a wide variety of Intelligent Transportation Systems (ITS) applications including traffic management, safety, security and others. The ATC Standards are being developed and maintained under the direction of the ATC Joint Committee (JC) which is made up of representatives from the American Association of State Highway and Transportation Officials (AASHTO), the Institute of Transportation Engineers (ITE), and the National Electrical Manufacturers Association (NEMA). (ITE Standards)

Alternating Current (ac) – a current that reverses its magnitude and direction of flow at regular intervals. The rate of reversal is expressed in hertz (cycles per second).

American Wire Gauge (AWG) – is a standardized wire gauge system used since 1857 for the diameters of round, solid, nonferrous, electrically conducting wire. (American Society for Testing and Materials)

Americans with Disabilities Act of 1990 (ADA) – requirements ensuring equal opportunity for persons with disabilities in employment, State and local government services, public accommodations, commercial facilities, and transportation. (ADA)

Ampere – the unit expressing the rate of flow of electrons through a conductor. One ampere is the current flowing through a 1-ohm resistance with 1-volt pressure.

Analog – an electronic design that uses continuously varying voltages, rather than discrete digital values.

Glossary of Terms

Approach – all lanes of traffic moving towards an intersection or a midblock location from one direction, including any adjacent parking lane(s). (MUTCD)

Arterial – a main street generally considered to be a thoroughfare with preferential right-of-way.

Auxiliary Equipment – separate devices used to add supplementary features to a controller assembly (NEMA).

Average Day – a day representing traffic volumes normally and repeatedly found at a location; typically, a weekday when volumes are influenced by employment or a weekend day when volumes are influenced by entertainment or recreation. (MUTCD)

Back Panel – a board within the controller cabinet upon which are mounted field terminals, fuse receptacles or circuit breakers, and other portions of the controller assembly not included in the controller unit or auxiliary devices.

Background Cycle – cycle length run at the master controller that, once at the start of the cycle, outputs the system reference to the local controllers. May also be run at a controller operating TBC, which supervises the actuated operation of the intersection.

Band (Green Band) – through or green elapsed time between the first and last possible vehicle permitted through an intersection on a progressive coordination system.

Glossary of Terms

Beacon – a highway traffic signal with one or more signal sections that operates in a flashing mode. (MUTCD)

Cable – a group of separately insulated conductors wrapped together and covered with an outer jacket.

California Department of Transportation (Caltrans) – manages more than 45,000 miles of California’s highway and freeway lanes, provides inter-city rail services, permits more than 400 public-use airports and special-use hospital heliports, and works with local agencies. Caltrans carries out its mission of improving mobility across California with six primary programs: Aeronautics, Highway Transportation, Mass Transportation, Transportation Planning, Administration and the Equipment Service Center. (California Department of Transportation)

Call – a registration demand for right-of-way by traffic and controlling unit (NEMA). A call comes to the controller from a detector at the intersection upon vehicle approach. The approach is defined by both the distance and direction of travel.

Canadian Electrical Code, CE code (CEC), or CSA C22.1 code – since 1927, the Canadian Standards Association’s (CSA’s) Canadian Electrical Code has provided the signature standards for addressing shock and fire hazards of electrical products in Canada which is regularly updated to address changing technology and operating conditions. (CSA)

Glossary of Terms

Changeable Message Sign (CMS) – also known as Variable Message Sign (VMS) or Dynamic Message Sign (DMS). CMS’s are traffic control devices used for traffic warning, regulation, routing and management, and are designed to affect the behavior of motorists (thus improve the flow of traffic) by providing real-time highway related information. (ITS)

Circuit – a closed path followed by an electric current.

Coil – a coiled conductor, wound on a form or core, which uses electromagnetic induction to cause changes in a current.

Conductor – a medium for transmitting electrical current. A conductor usually consists of copper or other electrically conductive materials.

Conflict Monitor Unit (CMU) – a device used to detect and respond to improper or conflicting signal indications and improper operating voltages in a traffic controller assembly. Monitors “faults” in controller operation (such as conflicting phases), monitors condition of controller (voltage and programming). (MUTCD)

Conflicting Phases – two or more traffic phases which will cause interfering (i.e., conflicting) traffic movements if operated concurrently.

Glossary of Terms

Controller Assembly – a complete electrical device mounted in a cabinet for controlling the operation of a highway traffic signal. (MUTCD)

Controller Unit – that part of a controller assembly that is devoted to the selection and timing of the display of signal indications. (MUTCD) Also referred to as the **Dispatcher** or **Timer**. Another controller class (i.e., Type 170, 179, and 2070) standardizes hardware modules and uses specialized software to implement traffic management functions.

Cross Talk – the adverse interaction from two channels on the same amplifier on each other from sensors in the road. Crosstalk can occur via mutual coupling of magnetic fields in nearby inductive loops.

Crosswalk – Any portion of a roadway at an intersection or elsewhere distinctly indicated as a pedestrian crossing by lines on the surface, which may be supplemented by a contrasting pavement texture, style, or color. (MUTCD)

Cycle Length – the time required for one complete sequence of signal indications. (MUTCD)

Dark Mode – the lack of all signal indications at a signalized location. (The dark mode is most associated with power failures, ramp meters, beacons, and some moveable bridge signals.) (MUTCD)

Demand – the request for service, e.g., one or more vehicles desiring to use a given segment of roadway during a specified unit of time.

Glossary of Terms

Demand Operation – a mode of operation whereby the service provided at an intersection reflects the presence of demand for that service without regard to background cycles. (Traffic Detector Handbook, Third Edition, Volume II)

Density – a measure of the concentration of vehicles, stated as the number of vehicles per mile per lane.

Department of Transportation (DOT) – Established in 1966 as a federal Cabinet department of the United States government concerned with transportation. The Department's mission is to serve the United States by ensuring a fast, safe, efficient, accessible and convenient transportation system that meets our vital national interests and enhances the quality of life of the American people, today and into the future. (DOT)

Detection Zone – that area of the roadway within which a vehicle will be detected by a vehicle sensor (NEMA). Also called zone of detection, sensing zone, area of detection, detection area, effective loop area, field of influence, field of view, or footprint.

Detector – a device used for determining the presence or passage of vehicles or pedestrians. (MUTCD)

Detector Amplifier (or Electronics Unit) – An electronic device that energizes the wire loop(s), monitors the loop(s) inductance by filtering and amplifying the signals it receives, and responds to a predetermined decrease in inductance with an output that indicates the passage or presence of vehicles in the detection zone.

Glossary of Terms

Direct Current – an electric current that is time-independent or, by extension, periodic current the direct component of which is of primary importance.

Dual-Arrow Signal Section – a type of signal section designed to include both a yellow arrow and a green arrow. (MUTCD)

Emergency Vehicle Traffic Control Signal – a special traffic control signal that assigns the right-of-way to an authorized emergency vehicle. (MUTCD)

Equal Employment Opportunity (EEO) – prohibits specific types of job discrimination in certain workplaces. (U.S. Department of Labor)

Flasher – a device used to turn highway traffic signal indications on and off at a repetitive rate of approximately once per second. (MUTCD)

Flashing Mode – a mode of operation in which at least one traffic signal indication in each vehicular signal face of a highway traffic signal is turned on and off repetitively. (MUTCD)

Frequency-Modulated Continuous Wave (FMCW) – is a radar system where a known stable frequency continuous wave energy is modulated by a triangular modulation signal so that it varies gradually and then mixes with the signal reflected from a target object (vehicle) with this transmit signal to produce a detection.

Glossary of Terms

Fully-Actuated Operation – a type of traffic control signal operation in which all signal phases function on the basis of actuation. (MUTCD)

High-Density Polyethylene (HDPE) or Polyethylene High-Density (PEHD) – a type of conduit used in traffic signals installations (typically in drilling installations), made of a dense, economical, hydrocarbon-plastic having good moisture barrier and chemical resistance but low gas barrier properties.

Highway Traffic Signal – a power operated traffic control device by which traffic is warned or directed to take some specific action. These devices do not include signals at toll plazas, power-operated signs, illuminated pavement markers, warning lights, or steady-burn electric lamps. (MUTCD)

Institute of Transportation Engineers (ITE) – an international educational and scientific association of transportation professionals who are responsible for meeting mobility and safety needs. ITE facilitates the application of technology and scientific principles to research, planning, functional design, implementation, operation, policy development and management for any mode of transportation. (ITE)

Intelligent Transportation Systems (ITS) – improves transportation safety and mobility and enhances productivity through the use of advanced information and communications technologies. ITS encompass a broad range of wireless and wire line communications-based information and electronics technologies. (ITS)

Glossary of Terms

International Municipal Signal Association (IMSA) – Organization dedicated to providing quality certification programs for the safe installation, operation and maintenance of public safety systems; delivering value for members by providing the latest information and education in the industry. (IMSA)

Intersection – (a) the area embraced within the prolongation or connection of the lateral curb lines, or if none, the lateral boundary lines of the roadways of two highways that join one another at, or approximately at, right angles, or the area within which vehicles traveling on different highways that join at any other angle might come into conflict; (b) the junction of an alley or driveway with a roadway or highway shall not constitute an intersection. (MUTCD)

Intersection Control Beacon – a beacon used only at an intersection to control two or more directions of travel. (MUTCD)

Interval – the part of a signal cycle during which signal indications do not change. (MUTCD)

Interval Sequence – the order of appearance of signal indications during successive intervals of a signal cycle. (MUTCD)

Lane-Use Control Signal – a signal face displaying signal indications to permit or prohibit the use of specific lanes of a roadway, or to indicate the impending prohibition of such use. (MUTCD)

Glossary of Terms

Light-Emitting Diode (LED) – a solid-state device embodying a PN junction, emitting optical radiation when excited by an electric current. LED is a PN junction semiconductor device that, by spontaneous emission, emits incoherent optical radiation by injecting electrons and/or holes across the PN junction.

Locking Detection Memory – a selectable feature of the circuit design for a controller phase, whereby the call of a vehicle arriving on the red (or yellow) is remembered or held by the controller after the vehicle leaves the detection area until it has been satisfied by the display of a green interval to that phase.

Loop Detector – an active sensor partly composed of wire wrapped in one or more circles and embedded in the pavement of a traffic lane, whose inductance decreases in response to the passage or presence of a (metallic) vehicle in the detection area that it creates.

Magnetic Detector – a passive device that senses changes in the Earth's magnetic field caused by the movement of a ferrous-metal vehicle in or near its detection zone. It is placed under or in the roadway to detect the passage of a vehicle over the sensor. These sensors generally detect only moving vehicles. Also known as induction and search coil magnetometers.

Major Street – the street normally carrying the higher volume of vehicular traffic. (MUTCD)

Malfunction Management Unit (MMU) – a device used to continually check for the presence of conflicting signal indications and other malfunctions and to provide an output response to conflict or malfunction. MMU is an advanced type of conflict monitor that also communicates and monitors controller function.

Glossary of Terms

Manual on Uniform Traffic Control Devices (MUTCD) – defines the standards used by road managers nationwide to install and maintain traffic control devices on all streets and highways.

The MUTCD is published by the Federal Highway Administration (FHWA) under 23 Code of Federal Regulations (CFR), Part 655, Subpart F. (MUTCD)

Manual of Uniform Traffic Control Devices for Canada (MUTCDC) – published by the Transportation Association of Canada (TAC), defines the standards used by road managers nationwide to install and maintain traffic control devices on all streets and highways in Canada. (MUTCDC)

Master – a control device for supervising TOD (time of day) changes of cycle lengths, offsets and splits, monitoring a system of secondary local controllers, maintaining time and date to all secondary controllers and/or accomplishing other supervisor functions. In the case of traffic responsive operation, the master generally includes computation and recording equipment. The master is also able to upload and download secondary databases.

Module – a packaged circuit or device easily removed without tools and contains a specified function. Frequently is duplicated to handle similar functions in different areas such as phase modules, load switch modules, etc. (Missouri DOT Engineering Policy Guide, Section 902.12, Glossary)

Megohmmeter (Megger) – A device used by power companies to measure very high resistance to earth ground.

Megohm – one million ohms, which is the unit of electrical resistance.

Glossary of Terms

Minor Street – the street normally carrying the lower volume of vehicular traffic. (MUTCD)

National Electrical Code (NEC), or NFPA 70 – is a standard that governs the use of electrical wire, cable, and fixtures, and electrical and optical communications cable installed in buildings. The NEC was developed by the NEC Committee of the American National Standards Institute (ANSI), was sponsored by the National Fire Protection Association (NFPA) and is identified by the description ANSI/NFPA 70-XXXX, the last four digits representing the year of the NEC revision. (ITS)

National Electrical Manufacturers Association (NEMA) – is a trade association of choice for the electrical manufacturing industry. Founded in 1926 and headquartered near Washington D.C., its approximately 450 member companies manufacture products used in the generation, transmission and distribution, control and end-use of electricity. These products are used in utility, medical imaging, industrial, commercial, institutional, and residential applications. (NEMA)

Non-Locking Memory – a mode of actuated controller unit operation that does not require memory (NEMA). In this mode of operation, the call of a vehicle arriving on the red (or yellow) is forgotten or dropped by the controller as soon as the vehicle leaves the detection area.

Occupancy – the percentage of time a sensor's detection zone is occupied. Occupancy is a pseudo-measure of density on a roadway. (Traffic Detector Handbook, Third Edition, Volume II)

Glossary of Terms

Offset – the time difference or interval in seconds or percentage of a cycle length between the start of the green indication of the coordinated phase and the system reference signal. This can be seen by watching Main Street GREEN at one intersection and the offset time when the next downstream intersection Main Street GREEN is on.

Passage Detection – the ability of a vehicle sensor to detect the passage of a vehicle moving through the detection zone and to ignore the presence of a vehicle stopped within the detection zone (NEMA).

Pedestrian Change Interval – an interval during which the flashing UPRAISED HAND (symbolizing DON'T WALK) signal indication is displayed. When a verbal message is provided at an accessible pedestrian signal, the verbal message is “wait.” (MUTCD)

Pedestrian Clearance Time – the time provided for a pedestrian crossing in a crosswalk, after leaving the curb or shoulder, to travel to the far side of the traveled way or to a median. (MUTCD)

Pedestrian Signal Head – a signal head, which contains the symbols WALKING PERSON (symbolizing WALK) and UPRAISED HAND (symbolizing DON'T WALK), that is installed to direct pedestrian traffic at a traffic control signal. (MUTCD)

Permissive Mode – a mode of traffic control signal operation in which , when a CIRCULAR GREEN signal indication is displayed, left or right turns are permitted to be made after yielding to pedestrians and/or oncoming traffic. (MUTCD)

Glossary of Terms

Phase – a traffic signal phase may have different meanings in traffic signal terminology: also see Signal Phase

- NEMA defines a **Vehicular phase** as a time period that is allocated to one specific vehicular traffic movement (e.g., eastbound through traffic).

Phase Sequence – the predetermined order of which one vehicular movement follows another. Determines which vehicular movement gets the green light and in which order.

Platoon – a group of vehicles or pedestrians traveling together as a group, either voluntarily or involuntarily, because of traffic signal controls, geometrics, or other factors. (MUTCD)

Polyvinyl Chloride (PVC) – a type of conduit used in traffic signal installation; it is a thermoplastic material. Thermoplastic materials are those that can be melted again and again. PVC is commonly used in the construction, industrial, and healthcare sector.

Preemption Control – the transfer of normal operation of a traffic control signal to a special control mode of operation. (MUTCD)

Presence Detection – the ability of a vehicle sensor to detect a moving or stopped vehicle in its detection zone.

Presence Loop Detector – an inductive loop detector that can detect the presence of a standing or moving vehicle in any portion of the effective loop area (ITE).

Glossary of Terms

Pretimed Operation – a type of traffic control signal operation in which none of the signal phases function on the basis of actuation. (MUTCD)

Priority Control – a means by which the assignment of right-of-way is obtained or modified. (MUTCD)

Protected Mode – a mode of traffic control signal operation in which left or right turns are permitted to be made when a left or right GREEN ARROW signal indication is displayed. (MUTCD)

Pushbutton – a button to activate pedestrian timing. (MUTCD)

Pushbutton Locator Tone – a repeating sound that informs approaching pedestrians that they are required to push a button to actuate pedestrian timing and that enables pedestrians who have visual disabilities to locate the pushbutton. (MUTCD)

Queue Length – number of vehicles stopped or slowly moving in a line, where the movement of each vehicle is constrained by that of the lead vehicle.

Ramp Control Signal – a highway traffic signal installed to control the flow of traffic onto a freeway at an entrance ramp or at a freeway-to-freeway ramp connection. (MUTCD)

Ramp Meter – see Ramp Control Signal. (MUTCD)

Glossary of Terms

Recall – an operational mode for an actuated controller whereby a phase, either vehicle or pedestrian, is displayed each cycle whether demand exists for it or not. Recall is placed into operation usually in a temporary or emergency situation.

Red Clearance Interval – an optional interval that follows a yellow change interval and precedes the next conflicting green interval. (MUTCD)

Right-of-Way (Assignment) – the permitting of vehicles and or pedestrians to proceed in a lawful manner in preference to other vehicles or pedestrians by the display of signal indications. (MUTCD)

Ring – two or more sequentially timed and individually selected conflicting phases so arranged as to occur in an established order.

Roadway Network – a geographical arrangement of intersecting roadways. (MUTCD)

Semi-actuated Operation – a type of traffic control signal operation in which at least one, but not all, signal phase's function based on actuation. (MUTCD)

Separate Left-Turn Signal Face – a signal face, for controlling a left turn movement that sometimes displays a different color of circular signal indication than the adjacent through signal faces display. (MUTCD)

Glossary of Terms

Shared Left-Turn Signal Face – a signal face, for controlling both a left turn movement and the adjacent through movement that always displays the same color of circular signal indication that the adjacent through signal face or faces display. (MUTCD)

Signal Backplate – a thin strip of material that extends outward from and parallel to a signal face on all sides of a signal housing to provide a background for improved visibility of the signal indications. (MUTCD)

Signal Coordination – the establishment of timed relationships between adjacent traffic control signals. (MUTCD)

Signal Face – that part of a traffic control signal provided for controlling one or more traffic movements on a single approach. (MUTCD)

Signal Head – an assembly of one or more signal sections. (MUTCD)

Signal Housing – that part of a signal section that protects the light source and other required components. (MUTCD)

Signal Indication – the illumination of a signal lens or equivalent device. (MUTCD)

Signal Lens – that part of the signal section that redirects the light coming directly from the light source and its reflector, if any. (MUTCD)

Glossary of Terms

Signal Louver – a device that can be mounted inside a signal visor to restrict visibility of a signal indication from the side or to limit the visibility of the signal indication to a certain lane or lanes, or to a certain distance from the stop line. (MUTCD)

Signal Phase – the right-of-way, yellow change, and red clearance intervals in a cycle that are assigned to an independent traffic movement or combination of movements. (MUTCD)

Signal Section – the assembly of a signal housing, signal lens, and light source with necessary components to be used for providing one signal indication. (MUTCD)

Signal System – two or more traffic control signals operating in signal coordination. (MUTCD)

Signal Timing – the amount of time allocated for the display of a signal indication. (MUTCD)

Signal Visor – that part of a signal section that directs the signal indication specifically to approaching traffic and reduces the effect of direct external light entering the signal lens. (MUTCD)

Signal Warrant – a threshold condition that, if found to be satisfied as part of an engineering study, shall result in analysis of other traffic conditions or factors to determine whether a traffic control signal or other equipment is justified. (MUTCD)

Speed Limit Sign Beacon – a beacon used to supplement a SPEED LIMIT sign. (MUTCD)

Glossary of Terms

Split – a division of the cycle length allocated to each of the various phases or vehicular movements (normally expressed in percent but can also be in seconds).

Split Phasing – serving an intersection one approach at a time.

Steady (Steady Mode) – the continuous illumination of a signal indication for the duration of an interval, signal phase, or consecutive signal phases. (MUTCD)

Stop Beacon – a beacon used to supplement a STOP sign, a DO NOT ENTER sign, or a WRONG WAY sign. (MUTCD)

Terminal – any fitting used for making a convenient electrical connection.

Time-Based Coordination – control systems in which basic coordination is provided by a highly accurate real time clock within the traffic signal controller. This information is used to determine the local signal timing of offset and cycle/split or actuated timing based on the Time-of-Day/Day-of-Week. Also called time-based coordinated control.

Time-of-Day (TOD) – timing plans which are pre-developed based upon traffic counts taken on the roadways. Signal timing usually has a minimum of three different timing plans, those being the A.M. (morning) peak period, P.M. (evening) peak period, and off-peak period. (ITE)

Glossary of Terms

Traffic Control Signal (Traffic Signal) – any highway traffic signal by which traffic is alternately directed to stop and permitted to proceed. (MUTCD)

Transportation Association of Canada (TAC) – is a national association with a mission to promote the provision of safe, secure, efficient, effective, and environmentally and financially sustainable transportation services in support of Canada’s social and economic goals. (TAC)

Transportation Electrical Equipment Specifications (TEES) – This publication contains specifications for transportation electrical equipment, with focus on Intelligent Transportation Systems (ITS). Included are specifications for the following type of equipment: general, enhanced controller unit and associated modules, auxiliary and ITS cabinet units, detector sensor units, elements and isolator models, ITS cabinet assembly, and peripheral and controller.

Twisted Pair – two insulated conductors twisted together with each end marked for identification.

Variable Initial Interval – a controller design feature that adjusts the duration of the initial green time interval accordingly to the number of vehicles in the queue.

Vibrotactile Pedestrian Device – a device that communicates, by touch, information about pedestrian timing using a vibrating surface. (MUTCD)

Glossary of Terms

Visibility-Limited Signal Face or Signal Section – a type of signal face or signal section designed (or shielded, hooded, or louvered) to restrict the visibility of a signal indication from the side, to a certain lane or lanes, or to a certain distance from the stop line. (MUTCD)

Volts of Alternating Current (VAC – for 120 VAC) – a measurement of how many volts of alternating current are being carried. Alternating current is current which constantly changes in amplitude, and which reverses direction at regular intervals. (Integrated publishing)

Walk Interval – an interval during which the WALKING PERSON (symbolizing WALK) signal indication is displayed. When a verbal message is provided at an accessible pedestrian signal, the verbal message is “walk sign”. (MUTCD)

Warning Beacon – a beacon used only to supplement an appropriate warning or regulatory sign or marking. (MUTCD)

Yellow Change Interval – the first interval following the green interval during which the yellow signal indication is displayed. (MUTCD)

IMSA Traffic Signal Field Technician II

This concludes this presentation



Advancing the Future of Public Safety